

IBM Netfinity

**ServeRAID-3H and ServeRAID-3L
Ultra2 SCSI Adapters
Installation and User's Guide**

IBM Netfinity

**ServeRAID-3H and ServeRAID-3L
Ultra2 SCSI Adapters
Installation and User's Guide**



Note

Before using this information and the product it supports, be sure to read the general information under Appendix A, "Product Warranties and Notices" on page 171.

First Edition (September 1998)

INTERNATIONAL BUSINESS MACHINES CORPORATION PROVIDES THIS PUBLICATION "AS IS" WITHOUT WARRANTY OF ANY KIND, EITHER EXPRESS OR IMPLIED, INCLUDING, BUT NOT LIMITED TO, THE IMPLIED WARRANTIES OF MERCHANTABILITY OR FITNESS FOR A PARTICULAR PURPOSE. Some jurisdictions do not allow disclaimer of express or implied warranties in certain transactions, therefore, this statement may not apply to you.

This publication could include technical inaccuracies or typographical errors. Changes are periodically made to the information herein; these changes will be incorporated in new editions of the publication. IBM may make improvements and/or changes in the product(s) and/or the program(s) described in this publication at any time.

This publication was developed for products and services offered in the United States of America and the United Kingdom. It is possible that this publication may contain reference to, or information about, IBM products (machines and programs), programming, or services that are not announced in your country. Such references or information must not be construed to mean that IBM intends to announce such IBM products, programming, or services in your country.

Requests for technical information about IBM products should be made to your IBM reseller or IBM marketing representative.

No part of this publication may be reproduced or distributed in any form or by any means without prior permission in writing from the International Business Machines Corporation.

© Copyright International Business Machines Corporation 1996, 1998. All rights reserved.

Note to U.S. Government Users — Documentation related to restricted rights — Use, duplication or disclosure is subject to restrictions set forth in GSA ADP Schedule Contract with IBM Corp.

Contents

About This Book	vii
How This Book Is Organized	vii
Notices Used in This Book	viii
Chapter 1. Getting Started	1
Option Package Contents	2
Installation Overview	3
Understanding RAID Technology	5
Interleave Depth and Stripe-Unit Size	5
Supported RAID Levels	6
Chapter 2. Installing and Cabling the Adapter	11
Adapter Features	12
Connector Locations	12
Battery Backup Cache Option	14
Installing the ServeRAID Adapter	15
Connecting External Devices	18
Chapter 3. Using the Configuration Programs	19
Using the ServeRAID Configuration Program	20
Starting the Configuration Program	22
Using the Configuration Mode	24
Using the Information Mode	30
Changing the ServeRAID Configuration Settings	40
Using the Tool Bar	41
Using the Menu Bar	42
Using the ServeRAID Mini-Configuration Program	51
Viewing the Controller Status	52
Viewing the Configuration	53
Using the Advanced Configuration Functions	53
Chapter 4. Installing Device Drivers and Utility Programs	57
IBM ServeRAID Configuration CD and Diskettes	59
Administration and Monitoring Program	60
Programs for Windows NT and Windows 95	61
Background-Server Components	62
Programs for OS/2 and NetWare	62

Programs for OpenServer and UnixWare	63
Installing the ServeRAID WIN32-Based Program	63
Installing ServeRAID Device Drivers	65
Installing Device Drivers for Windows NT	65
Installing Device Drivers for NetWare	69
Installing Device Drivers for OS/2	74
Installing Device Drivers for OpenServer	78
Installing Device Drivers for UnixWare	82
Starting the Background-Server Components	88
Using the Background-Server Components	89
IPSSSEND and IPSMON Programs	92
Installing IPSSSEND and IPSMON for OS/2, Windows NT, or NetWare	93
Installing IPSSSEND and IPSMON for OpenServer	95
Installing IPSSSEND and IPSMON for UnixWare	95
Installing IPSSSEND for DOS	96
Chapter 5. Starting and Using the Utility Programs	97
Starting the Administration and Monitoring Program	98
Using the Administration and Monitoring Program	100
Using the Options Pull-Down Menu	100
Using the Administration Functions	105
Using the Monitoring Functions	121
Starting the IPSSSEND Program	126
Using the IPSSSEND Program	127
Server Roll-Out Commands	127
Error-Recovery Commands	130
Problem-Isolation and Debug Commands	133
RAID Configuration Commands	137
Starting the IPSMON Program	138
Using the IPSMON Program	139
Chapter 6. Solving ServeRAID Problems	141
ServeRAID Adapter and Controller Messages	142
ServeRAID Startup Messages	142
ServeRAID POST Messages	150
ServeRAID ISPR, BCS, and ECS Codes	151
Rebuilding a Defunct Drive	159
Guidelines for the Rebuild Operation	159
General Information about the Rebuild Operation	160

Automatically Rebuilding the Defunct Drive	160
Chapter 7. Getting Help, Service, and Information	161
Before You Call for Service	162
Getting Customer Support and Service	162
Using Electronic Support Services	162
Using the World Wide Web	163
Getting Information by Fax	164
Getting Help Online	164
Getting Help by Telephone	165
Getting Help Around the World	167
Purchasing Additional Services	167
900-Number Operating System and Hardware Support Line	167
Network and Server Support Line	168
Ordering Support Line Services	168
Warranty and Repair Services	169
Ordering Publications	170
Appendix A. Product Warranties and Notices	171
Warranty Statements	171
IBM Statement of Limited Warranty for United States, Puerto Rico, and Canada (Part 1 - General Terms)	171
IBM Statement of Warranty Worldwide except Canada, Puerto Rico, Turkey, United States (Part 1 - General Terms)	175
Part 2 - Worldwide Country-Unique Terms	178
Notices	183
Year 2000 Readiness and Instructions	183
Trademarks	184
United Kingdom Telecommunications Safety Requirements	185
European Community Directive Conformance Statement	186
Industry Canada Class A Emission Compliance Statement	186
Australia and New Zealand Class A Statement	186
Taiwanese Electromagnetic Interference (EMI) Statement	187
Index	189

About This Book

This book provides the information needed to install and configure an IBM ServeRAID-3H Ultra2 SCSI Adapter or an IBM ServeRAID-3L Ultra2 SCSI Adapter. You also can use the configuration and reference information in this book to configure the IBM ServeRAID controllers provided on some IBM Netfinity and PC Server system boards.

How This Book Is Organized

Chapter 1, "Getting Started," contains introductory information about the IBM ServeRAID-3H and ServeRAID-3L adapters, a content listing for the adapter option packages, an installation overview, and general information about RAID technology.

Chapter 2, "Installing and Cabling the Adapter," provides information about the standard features of the ServeRAID-3H and ServeRAID-3L adapters, and instructions for installing and cabling the adapters.

Chapter 3, "Using the Configuration Programs," explains how to use the IBM ServeRAID Configuration Program and the IBM ServeRAID Mini-Configuration Program. You can refer to the information in this chapter when configuring one or more devices attached to a ServeRAID adapter or controller.

Chapter 4, "Installing Device Drivers and Utility Programs," contains the instructions needed to install the ServeRAID device drivers and programs provided on the IBM ServeRAID Configuration CD and diskettes that came with the ServeRAID adapters.

Chapter 5, "Starting and Using the Utility Programs," contains instructions for starting and using the ServeRAID Administration and Monitoring, IPSEND, and IPSMON programs. You can use these operating-system specific programs to maintain and monitor your ServeRAID subsystem.

Chapter 6, "Solving ServeRAID Problems," describes the ServeRAID POST error codes and startup messages. This chapter also includes some basic information about rebuilding a defunct drive.

Chapter 7, "Getting Help, Service, and Information," provides information about accessing the IBM Bulletin Boards, HelpCenter, and World Wide Web sites to obtain future code and information updates for the ServeRAID adapters and controllers.

Appendix A, "Product Warranties and Notices," contains warranty information, product notices, and trademarks.

Notices Used in This Book

This book contains notices to highlight information as follows:

- **Notes:**

These notices provide important tips, guidance, or advice.

- **Attention:**

These notices indicate possible damage to programs, devices, or data. An attention notice is placed just *before* the instruction or situation in which damage could occur.

Chapter 1. Getting Started

This book provides the information needed to install and configure an IBM ServeRAID-3H Ultra2 SCSI Adapter or an IBM ServeRAID-3L Ultra2 SCSI Adapter. These high-performance, redundant array of independent disk (RAID) adapters are ideally suited for data-storage environments that require superior performance, flexibility, and reliable data storage. (See “Adapter Features” on page 12 for more information.)

You also can use the configuration and reference information in this book to configure the IBM ServeRAID controllers provided on some IBM Netfinity and PC Server system boards.

This chapter contains:

Option Package Contents	2
Installation Overview	3
Understanding RAID Technology	5
Interleave Depth and Stripe-Unit Size	5
Supported RAID Levels	6
RAID Level-0	6
RAID Level-1	8
Enhanced RAID Level-1	9
RAID Level-5	10

Option Package Contents

In addition to this book, the ServeRAID option package contains:

- IBM Netfinity ServeRAID-3L Ultra2 SCSI Adapter or IBM Netfinity ServeRAID-3H Ultra2 SCSI Adapter

Attention:

Do not open the static-protective bag containing the adapter until you are instructed to do so.

- IBM ServeRAID Support Package:
 - *IBM ServeRAID Configuration CD*
 - *IBM ServeRAID Device Driver Diskette*
 - *IBM ServeRAID Device Drivers for SCO Operating Systems Diskette*

See Chapter 4, “Installing Device Drivers and Utility Programs” on page 57 for more detailed information.

- DASD Status Cable (for use with the PC Server 330)
- IBM ServeRAID Channel 3 Cable option kit

This cable comes with the ServeRAID-3H adapter only. You can attach this cable to the ServeRAID-3H adapter to convert the internal SCSI channel connector to an external connector. See “ServeRAID-3H Adapter” on page 13 for more information.

Contact your place of purchase if any items are missing or damaged.

Installation Overview

This book contains reference, installation, configuration, and administration information for the IBM ServeRAID-3H adapter, ServeRAID-3L adapter, and ServeRAID controllers. In addition to this book, you might need to refer to your IBM server documentation for Safety information, connector locations, and for adapter and hard disk drive installation instructions.

The information that you will need to install or configure your IBM ServeRAID subsystem depends on the type of ServeRAID adapter or controller you are using and your familiarity with RAID technology.

A typical installation and configuration of an IBM ServeRAID subsystem consists of the following steps:

1 Learn about RAID technology.

The “Understanding RAID Technology” section in this chapter contains general information about RAID technology. If you already are familiar with the IBM implementation of RAID technology, you might want to start your installation with step 2.

2 Install the ServeRAID-3H or ServeRAID-3L adapter.

Chapter 2, “Installing and Cabling the Adapter” provides information about the standard features of the ServeRAID-3H and ServeRAID-3L adapters, and installation and cabling instructions for the adapters. You will not need the information in this chapter if you are using a ServeRAID controller on an IBM Netfinity or PC Server system board.

3 Use the ServeRAID Configuration Programs to configure your disk arrays.

Chapter 3, “Using the Configuration Programs” explains how to use the IBM ServeRAID Configuration Program and the IBM ServeRAID Mini-Configuration Program. You can refer to the information in this chapter or the online information in the configuration program when configuring one or more devices attached to a ServeRAID adapter or controller.

Attention:

The default setting for the stripe-unit size is 8 KB¹. If you want to use a different setting, be sure to change the stripe-unit size before you store data in the logical drives. After you store data in the drives, you cannot change the stripe-unit size without destroying data in the logical drives. (See “Interleave Depth and Stripe-Unit Size” on page 5 and page 46 for more information.)

- If you are configuring a ServeRAID-3H Ultra2 SCSI Adapter or a ServeRAID-3L Ultra2 SCSI Adapter, see Chapter 3, “Using the Configuration Programs” on page 19 for instructions.
- If you are configuring an IBM ServeRAID controller that came as a standard feature on an IBM Netfinity or PC Server system board, see the installation instructions and CDs provided with your server for information about starting the configuration programs for the server.

4 Install your operating system, ServeRAID device drivers, and ServeRAID utility programs.

You can skip this step if you are installing multiple ServeRAID adapters and you already installed your operating system and the most current versions of the ServeRAID device drivers and utility programs.

- To install these files for a ServeRAID-3H Ultra2 SCSI Adapter or a ServeRAID-3L Ultra2 SCSI Adapter, see the information provided with your operating system and Chapter 4, “Installing Device Drivers and Utility Programs” on page 57 for instructions.
- To install these files for an IBM ServeRAID controller that came as a standard feature on an IBM Netfinity or PC Server system board, see the installation instructions and CDs provided with your server for instructions.

¹ KB equals approximately 1000 bytes.

After you install the device drivers and utility programs, refer to Chapter 5, “Starting and Using the Utility Programs” on page 97.

Understanding RAID Technology

RAID is the technology of grouping several hard disk drives in a computer into an *array* that you can define as one or more logical drives. Each *logical* drive appears to the operating system as a single drive. This grouping technique greatly enhances logical-drive capacity and performance beyond the physical limitations of a single hard disk drive.

When you group multiple physical hard disk drives into a logical drive, the ServeRAID controller can transfer data in parallel from the multiple drives in the array. This parallel transfer yields data-transfer rates that are many times higher than with nonarrayed drives. This increased speed makes the system better able to meet the *throughput* (the amount of work in a given amount of time) or productivity needs of the multiple-user network environment.

The ability to respond to multiple data requests provides not only an impressive increase in throughput, but also a decrease in response time. The combination of parallel transfers and simultaneous responses to multiple requests allows disk arrays to provide a high level of performance in network environments.

Interleave Depth and Stripe-Unit Size

With RAID technology, data is *striped* across an array of hard disk drives. This data-distribution scheme complements the way the operating system requests data.

The granularity at which data from one file is stored on one drive of the array before subsequent data is stored on the next drive of the array is called the *interleave depth*.

You can control the interleave depth and maximize the performance of your ServeRAID controller by setting a stripe-unit size that is close

to the size of the system I/O requests. You can set the stripe-unit size to 8 KB, 16 KB, 32 KB, or 64 KB. For example, performance in transaction-based environments, which typically involve large blocks of data, might be optimal when the stripe-unit size is set to 32 KB or 64 KB; however, performance in file and print environments, which typically involve multiple small blocks of data, might be optimal when the stripe-unit size is set to 8 KB or 16 KB.

The collection, in logical order of these stripe units, from the first drive of the array to the last drive of the array, is called a *stripe*. (See page 46 for more information.)

Supported RAID Levels

Disk arrays are used to improve performance and reliability. The amount of improvement depends on the application programs that you run on the server and the RAID levels that you assign to the logical drives.

The ServeRAID adapters and controllers support RAID level-0, RAID level-1, Enhanced RAID level-1, and RAID level-5.

RAID Level-0

RAID level-0 stripes the data across all the drives in the array. This offers substantial speed enhancement, but provides for no data redundancy. RAID level-0 provides the largest capacity of the RAID levels offered, because no room is taken up for redundant data or data-parity storage.

The following illustration shows data arranged in an array of three hard disk drives defined as one RAID level-0 logical drive. Notice that the data is striped across all the drives in the array, but no copies of the data or parity information is stored.

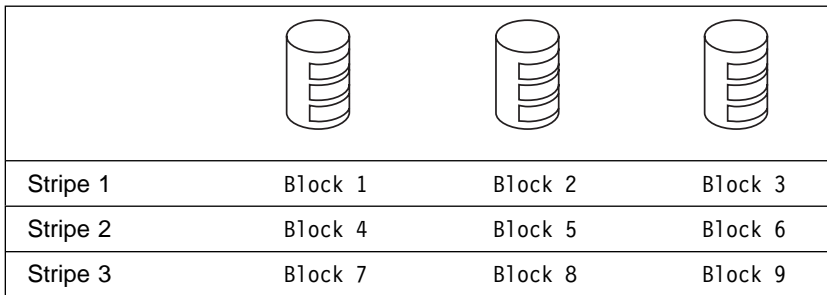

A hard disk failure within the array results in loss of data in the logical drive assigned RAID level-0, but *only in that logical drive*. If you have logical drives assigned RAID level-1 or level-5 in the same array, they will not lose data.

Note: The ServeRAID controller automatically assigns RAID level-0 to all logical drives in an array containing only one hard disk drive.

When you replace a failed drive, the ServeRAID controller can rebuild all the RAID level-1 and RAID level-5 logical drives automatically onto the replacement hard disk drive. However, any data stored in a failed RAID level-0 logical drive is lost.

Though the risk of data loss is present, you might want to assign RAID level-0 to one of the logical drives to take advantage of the speed offered with this RAID level. You could use this logical drive to enter data that you back up each day and for which safety is not of primary importance, that is, data that you can re-create easily. You also might want to use a RAID level-0 logical drive when the work you are doing requires maximum capacity.

RAID Level-1

RAID level-1 provides 100% data redundancy and requires two hard disk drives. With RAID level-1, the first half of a stripe is the original data; the second half of a stripe is a *mirror* (copy) of the data, but written to another drive.

Because the data is mirrored, the capacity of the logical drive when assigned RAID level-1 is 50% of the physical capacity of the two hard disk drives in the array.

The following illustration shows data arranged in an array of two hard disk drives defined as one RAID level-1 logical drive. Notice that the data on Drive B is a mirror copy of the data on Drive A.

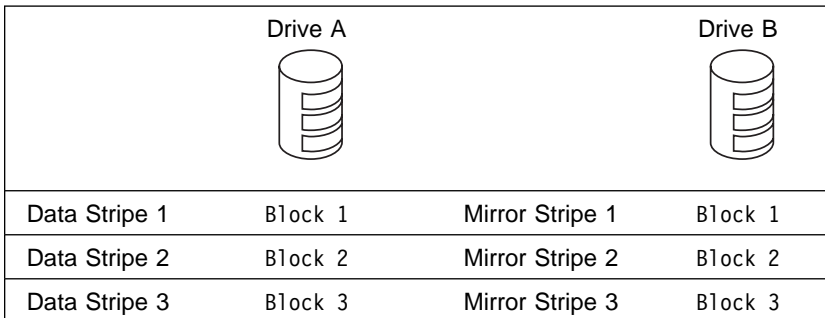

If one of the hard disk drives fails, the ServeRAID controller switches read and write requests to the remaining functional drive in the array.



Enhanced RAID Level-1

When you group more than two physical drives into an array and you select RAID level-1, the ServeRAID controller automatically assigns the IBM Enhanced RAID level-1 to the array.

The Enhanced RAID level-1 combines mirroring with data striping. This RAID level stripes data and copies of the data across all the drives in the array. As with the standard RAID level-1, the data is mirrored, and the capacity of the logical drive is 50% of the physical capacity of the grouping of hard disk drives in the array.

The Enhanced RAID level-1 requires a minimum of three drives and, depending upon the stripe-unit size, supports a maximum of eight or 16 drives.

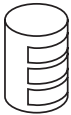
The following illustration shows data arranged in an array with three hard disk drives. The logical drive is assigned the Enhanced RAID level-1. Notice that the first stripe is the data stripe and the second stripe is the mirror (copy) of the first data stripe, but shifted one drive.

			
Data Stripe 1	Block 1	Block 2	Block 3
Mirror Stripe 1	Block 3	Block 1	Block 2
Data Stripe 2	Block 4	Block 5	Block 6
Mirror Stripe 2	Block 6	Block 4	Block 5

RAID Level-5

RAID level-5 requires a minimum of three hard disk drives. This RAID level stripes data and parity across all drives in the array. When an array is assigned RAID level-5, the capacity of the logical drive is reduced by one drive (for data-parity storage).

RAID level-5 is generally the most desirable choice, because it offers both data protection and increased throughput. RAID level-5 gives you higher capacity than RAID level-1, but RAID level-1 offers better performance.

The following illustration shows data arranged in an array with three hard disk drives. The logical drive is assigned RAID level-5. Notice that the storage of the data parity also is striped, and it shifts from drive to drive.

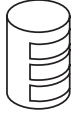
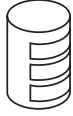
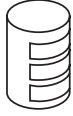
			
Stripe 1	Block 1	Block 2	Parity 1+2
Stripe 2	Block 3	Parity 3+4	Block 4
Stripe 3	Parity 5+6	Block 5	Block 6
Stripe 4	Block 7	Block 8	Parity 7+8

Chapter 2. Installing and Cabling the Adapter

This chapter provides installation and cabling instructions for the ServeRAID-3H and ServeRAID-3L adapters. Basic information about the standard features of these adapters is also included.

You will not need the information in this chapter if you are using a ServeRAID controller on an IBM Netfinity or PC Server system board.

This chapter contains:

Adapter Features	12
Connector Locations	12
ServeRAID-3L Adapter	13
ServeRAID-3H Adapter	13
Battery Backup Cache Option	14
Installing the ServeRAID Adapter	15
Connecting External Devices	18

Adapter Features

Standard features of the ServeRAID-3H and ServeRAID-3L adapters are as follows.

Feature	ServeRAID-3H	ServeRAID-3L
Arrays (max.)	8	8
Array Accelerator	Yes	Yes
Battery Backup	Yes (Optional)	No
Cache Memory	32 MB	4 MB
Hard Disk Drives (max.)	45	15
Hot-Spare Drives (max.)	16	15
Logical Drives (max.)	8	8
Microprocessor	40 MHz	25 MHz
SCSI Channels	3	1
SCSI Transfer Speed (max.)	80 MB /sec.	80 MB /sec.
Supported RAID Levels	0, 1, 5, and Enhanced-1	0, 1, 5 and Enhanced-1
System PCI Data Bus	64 bit	32 bit

Connector Locations

This section provides illustrations of the channel connectors, cable connectors, and optional devices for the ServeRAID-3H and ServeRAID-3L adapters.

The light-emitting diodes (LEDs) on the adapters indicate activity on the SCSI channels and provide diagnostic information for trained service technicians.

ServeRAID-3L Adapter

The ServeRAID-3L adapter has two channel connectors: one internal and one external. These channel connectors share the same SCSI bus. You can attach SCSI devices to either the internal or external channel connector, but you cannot attach devices to both connectors simultaneously.

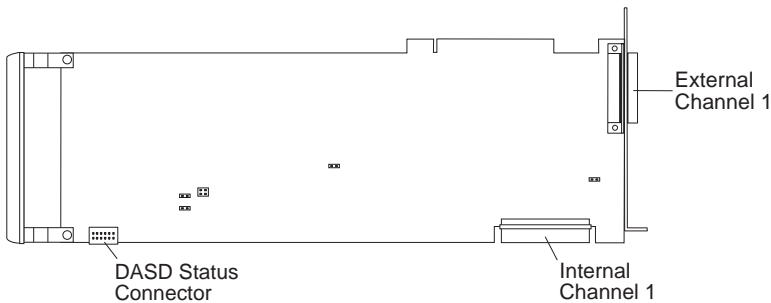

Figure 1. ServeRAID-3L Adapter

ServeRAID-3H Adapter

The ServeRAID-3H adapter has three independent SCSI channel connectors: Channel 1, Channel 2, and Channel 3. Each of these SCSI channels support up to 15 physical devices.

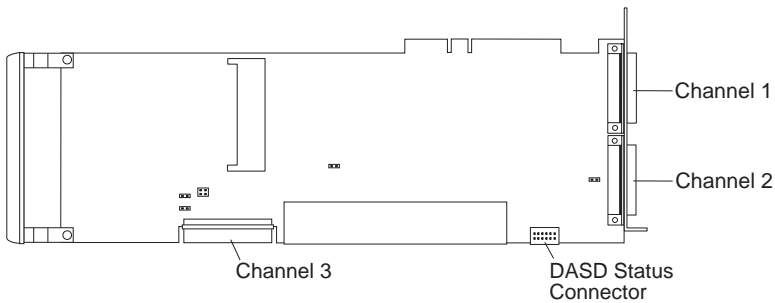

Figure 2. ServeRAID-3H Adapter

You can attach internal SCSI devices to the Channel 3 connector, and you can attach external SCSI devices to the Channel 1 and Channel 2 connectors.

If you want to attach external SCSI devices to the Channel 3 connector, use the following illustration to help you install the ServeRAID Channel 3 Cable option that comes with the adapter.

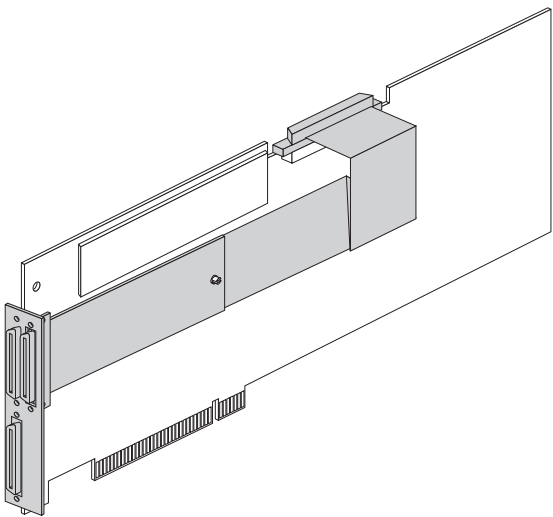

Figure 3. ServeRAID-3H Adapter with the Channel 3 Cable Installed

Battery Backup Cache Option

To protect your data when using the write-back mode, IBM offers an optional Battery Backup Cache for the ServeRAID-3H adapter. With this option installed and enabled, the data being stored in the ServeRAID cache memory is protected during a power outage or failure. For more information about this option, contact your IBM reseller or IBM marketing representative.

Installing the ServeRAID Adapter

During the installation, you will need a small, flat-blade screwdriver and the documentation that comes with your server.

To install the ServeRAID-3H or ServeRAID-3L adapter:

1. Review the Safety Information provided with your IBM server.

Note: Some IBM Netfinity servers support hot-swap PCI features, which allow you to install or remove PCI adapters without turning off the server. Review the information provided with your server to determine if your model supports these features. If your Netfinity model provides hot-swap PCI support, you do not need to turn off your server to install this adapter. However, you will need to restart your server to run the ServeRAID Configuration Program.

2. If your server model does not support hot-swap PCI, turn off the server; then, disconnect all power cords and cables from the server.
3. Remove the server cover and locate an empty PCI expansion slot for the adapter. Choose a slot with the most clearance from any other installed components, such as the microprocessor. If necessary, see your server documentation for more detailed information about the expansion slots.

Note: For Netfinity 3000 servers, the ServeRAID adapters are supported only when installed in PCI slot 3. *Do not* install these adapters in PCI slots 1 or 2. Before you can install a ServeRAID adapter in a Netfinity 3000, you must first remove the standard SCSI adapter that comes in PCI slot 3. You can install and use the standard SCSI adapter in PCI slots 1 or 2, but devices attached to the standard SCSI adapter will no longer provide startup (boot) support.

4. Remove the expansion-slot cover, if applicable.

5. Touch the static-protective package containing the adapter to a metal expansion-slot cover on the server. This reduces any static electricity from the package and from your body.
6. Remove the adapter from the static-protective package, holding the adapter by the edges. Do not touch any exposed components on the adapter.
7. Insert the adapter in the PCI expansion slot. Press the adapter firmly into the slot so that it is fully seated in the slot.
8. Tighten the expansion-slot screw on the top of the adapter.
9. If you are installing the adapter in an IBM PC Server 330 and you intend to use this adapter in place of the ServeRAID controller on the system board, continue with step 10. Otherwise, go to step 11.
10. Connect one end of the DASD status cable (provided with the adapter) to the DASD status connector on the adapter (see "Connector Locations" on page 12); then, connect the other end of the cable to the DASD status connector on the hot-swap backplane.

If necessary, see your server documentation or the system label inside the server cover for the location of the DASD status connector on the backplane.
11. Connect the SCSI cables to the adapter. If you intend to attach external devices only, go to step 15. Otherwise, continue with step 12.
12. Connect one end of a 68-pin VHDCI² SCSI cable (separately purchased or already in your server) to the internal channel connector on the ServeRAID adapter.

Note: See "Connector Locations" on page 12 for the channel connector locations.
13. Connect the other end of the SCSI cable to the hot-swap backplane or to a SCSI device in the server. (See your server

² VHDCI stands for Very High Density Connector Interface.

documentation or the system label inside the server cover for the location of the SCSI connector on the backplane.)

Note: When the ServeRAID adapter and a SCSI CD-ROM drive are connected to the same SCSI bus (cable), you must enable the ServeRAID bootable (startable) CD-ROM feature before the adapter or controller can start a bootable CD-ROM. See “Setting the Bootable CD-ROM Feature” on page 55 for more information.

14. If you have drives to install, install them now. See your server documentation for drive installation instructions.

Notes:

- a. The ServeRAID adapters and controllers use SCSI ID 7.
 - b. Removable-media devices (such as CD-ROM or tape drives) connected to the same ServeRAID adapter or controller must all have unique SCSI IDs, even when they are connected to different channels. For example, if you have a CD-ROM drive on Channel 1 set to SCSI ID 6, you must not have a tape drive on Channel 2 or Channel 3 of the same ServeRAID adapter or controller set to SCSI ID 6.
15. Install the server cover.
 16. If you disconnected the cables and power cords in step 2 on page 15, reconnect the cables and cords. See your server documentation if you need detailed instructions.
 17. If you want to attach an external SCSI device to the ServeRAID adapter, continue with “Connecting External Devices” on page 18. Otherwise, go to Chapter 3, “Using the Configuration Programs” on page 19.

Connecting External Devices

To attach SCSI devices to an external channel connector on the ServeRAID adapter:

1. Connect one end of a 68-pin VHDCI SCSI cable to an external channel connector on the ServeRAID adapter.

Note: See “Connector Locations” on page 12 for the channel connector locations.

2. Connect the other end of the SCSI cable to the external SCSI device.
3. Go to Chapter 3, “Using the Configuration Programs” on page 19.

Chapter 3. Using the Configuration Programs

This chapter provides instructions for using the IBM ServeRAID Configuration and Mini-Configuration Programs. You can use the information in this chapter and the online information in the configuration programs when configuring one or more devices attached to a ServeRAID adapter or controller. You must use the IBM ServeRAID Configuration Program to configure your disk arrays *before* you install an operating system or store data on the hard disk drives attached to the ServeRAID adapter or controller.

This chapter contains

Using the ServeRAID Configuration Program	20
Starting the Configuration Program	22
Using the Configuration Mode	24
Learning about Express Configuration	25
Using Express Configuration	26
Learning about Custom Configuration	27
Using Custom Configuration	28
Using the Information Mode	30
Viewing the Device and Configuration Information	31
System Information Panel	31
ServeRAID Controller Information Panel	31
Array Information Panel	33
Logical Drive Information Panel	33
Hot-Spare Drive Information Panel	34
Physical Drive Information Panel	35
Channel Information Panel	36
Drive States	37
Changing the ServeRAID Configuration Settings	40
Using the Tool Bar	41
Using the Menu Bar	42
Using the ServeRAID Mini-Configuration Program	51
Viewing the Controller Status	52
Viewing the Configuration	53
Using the Advanced Configuration Functions	53
Setting the Bootable CD-ROM Feature	55

Using the ServeRAID Configuration Program

The graphical interface in the ServeRAID Configuration Program makes it easy for you to create, delete, change, or view your ServeRAID configuration.

Before you begin, review the following illustration to become familiar with the layout of the configuration program screens.

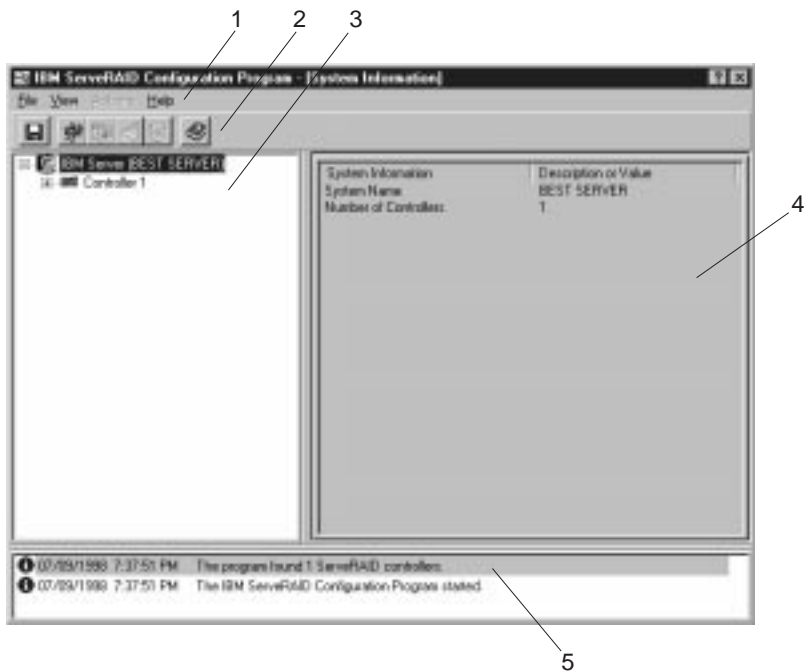

Figure 4. ServeRAID Configuration Screen Layout

Descriptions of the numbered areas are as follows:

- 1. Menu Bar** Provides standard File, View, Actions, and Help pull-down menus. See “Using the Menu Bar” on page 42 for more information.
- 2. Tool Bar** Provides quick-path icons for common tasks. The icons from left to right are Save the Configuration Event Log, Configure the ServeRAID Controller, Configure for Clustering, Scan for New or Removed Ready Drives, Create an Array, and Help. See “Using the Tool Bar” on page 41 for more information.
- 3. Main Tree** Provides an expandable tree view of your ServeRAID subsystem. You will perform most of your ServeRAID configuration and maintenance tasks by first selecting the ServeRAID controller, array, logical drive, hot-spare drive, or physical drive objects from this Main Tree.
- 4. Main Panel** Provides specific device information or configuration instructions. When the configuration program is in the Information mode and you select an object from the Main Tree, detailed information about the object appears in this panel. When the configuration program is in the Configuration mode, the instructions needed to configure your ServeRAID subsystem appear in this panel.
- 5. Event Viewer** Provides advisory and progressive-status information and messages during the ServeRAID configuration process. Each message appears with a time stamp, a date stamp, and an icon that classifies the severity of the event. Attention messages identify potential data-loss situations, and Fatal messages inform you when a failure has occurred.

Starting the Configuration Program

The ServeRAID Configuration Program runs in two modes: the *Configuration* mode and the *Information* mode.

In the Configuration mode, you can create or delete disk arrays, create or delete logical drives, and define your hot-spare drives. When this mode is active, only a limited set of functions is available from the Menu and Tool Bars. See “Using the Configuration Mode” on page 24 for more information.

In the Information mode, you can view the existing device and configuration information for your ServeRAID subsystem. When this mode is active, you can use the functions available from the Menu and Tool Bars to customize settings for your ServeRAID controllers. See “Using the Information Mode” on page 30 for more information.

The ServeRAID Configuration Program is provided on the *IBM ServeRAID Configuration CD* packaged with the ServeRAID adapter, and it also is provided on the configuration CD packaged with some IBM server models.

Notes:

1. If you are configuring a ServeRAID controller on a system board, see the installation instructions and CDs provided with your server for information about starting the configuration programs for the server.
2. To gain access to the ServeRAID Configuration or Mini-Configuration programs, you must restart the server.

To start the configuration program:

1. Insert the *IBM ServeRAID Configuration CD* (or the configuration CD that came with your server) into the CD-ROM drive; then, turn on the server.

One of the following screens will appear:

- If the configuration program detects unconfigured ServeRAID controllers, the program starts in the Configuration mode and a screen similar to the following appears.

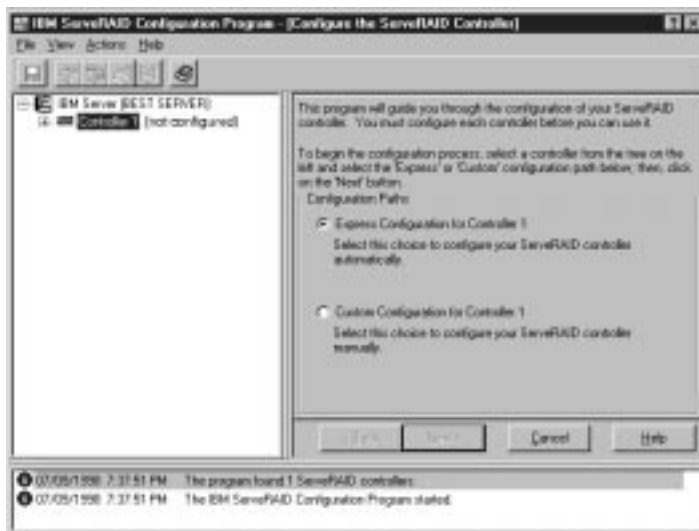



Figure 5. Configuration Mode Screen

Click on the **Cancel** button to switch from the Configuration mode to the Information mode.

- If the configuration program detects that all ServeRAID controllers in the server are configured, the program starts in the Information mode and a screen similar to the following appears.



Figure 6. Information Mode Screen

Click on the  icon on the Tool Bar to switch from the Information mode to the Configuration mode.

2. Continue with one of the following:

- “Using the Configuration Mode”
- “Using the Information Mode” on page 30

Using the Configuration Mode

You can use the Configuration mode to create up to eight independent disk arrays for each ServeRAID controller. The Configuration mode provides two configuration paths: *Express Configuration* and *Custom Configuration*.

Learning about Express Configuration

Express Configuration provides a quick and easy path for you to automatically configure your ServeRAID controller. This choice creates the most efficient ServeRAID configuration based on the number and capacity of the Ready drives available in your system. If four or more Ready drives of the same capacity are available, this choice also will define a *hot-spare drive* for the ServeRAID adapter or controller. A hot-spare drive is a physical drive that is defined for automatic use when a similar drive fails.

The Express Configuration choice groups up to 16 Ready drives of the same capacity into one disk array and defines one logical drive for each array. This choice defines the size of the logical drive, based on the amount of free space available, and it assigns the highest RAID level possible, based on the number of physical drives available.

For example, if your server contains one 1024 MB Ready drive, two 2150 MB Ready drives, and four 4300 MB Ready drives, Express Configuration will create three arrays and one hot-spare drive as follows:

- Array A:** The total capacity of this array is 1024 MB (1 x 1024 MB) and it contains one 1024 MB RAID level-0 logical drive.
- Array B:** The total capacity of this array is 4300 MB (2 x 2150 MB) and it contains one 2150 MB RAID level-1 logical drive.
- Array C:** The total capacity of this array is 12900 MB (3 x 4300 MB) and it contains one 8600 MB RAID level-5 logical drive.
- Hot Spare:** Express Configuration defines one of the four 4300 MB drives as a hot-spare drive, as follows:
- When there are four or more Ready drives of the same capacity, Express Configuration groups three of the drives into one array (as in Array C) and defines one of the drives as a hot spare.

- A hot-spare drive must be of equal or greater capacity than the drive that it is intended to replace. In this configuration, the 4300 MB drive can replace any failed drives in Array B or Array C.

Using Express Configuration

To use the Express Configuration path:

1. Click on the ServeRAID controller that you want to configure in the Main Tree.
2. Click on the **Express Configuration** radio button.
3. Click on the **Next** button.
4. Review the information that appears on the Configuration Summary screen.

Notes:

- a. Some operating systems have size limitations for logical drives. Before you save the configuration, you might want to verify that the size of the logical drive is appropriate for your operating system. See your operating-system documentation for more detailed information.
 - b. To change the configuration, click on a **Modify** icon button.
5. Click on the **Apply** button to accept and save the configuration.
 6. If you have not already done so, install your operating system. See the server documentation or the documentation provided with your operating system for more information.

After you install your operating system, see Chapter 4, “Installing Device Drivers and Utility Programs” on page 57 (or see the installation instructions provided with your server) for information about installing the ServeRAID device drivers and utility programs.

Learning about Custom Configuration

The Custom Configuration path allows you to manually configure your ServeRAID subsystem. Using this path, you can select the drives that you want to include in each array, define the number and size of the logical drives for each array, and select the drives that you want to use as hot spares.

Before you select the Custom Configuration path, consider the following:

- If you are not familiar with the IBM implementation of RAID technology, you might want to review the information provided in “Understanding RAID Technology” on page 5 before you begin.
- Each ServeRAID controller supports a maximum of eight arrays.
- Each ServeRAID controller supports a maximum of eight logical drives.

When you create an array, you group hard disk drives into one storage area. You can define this storage area as a single *logical* drive, or you can subdivide it into several logical drives. Each logical drive appears to the operating system as a single physical hard disk drive.

If you have only one array, you can define it as a single logical drive, or you can divide it into several logical drives. Typically, the first logical drive defined on the first ServeRAID adapter or controller found by the basic input/output system (BIOS) during startup will be your startup (boot) drive.

If you have two or more arrays, each array can be one logical drive, or you can divide each array into multiple logical drives, as long as the total number of logical drives for all of the arrays does not exceed eight.

Note: Independent of the RAID logical drives, most operating systems allow you to partition the logical drives further.

- The optimal way to create arrays is to use hard disk drives that have the same capacity.

Hard disk drive capacities influence the way you create arrays. Drives in an array can be of different capacities (1 GB³, or 2 GB, for example), but RAID controllers treat them as if they all have the capacity of the *smallest* disk drive.

For example, if you group three 1 GB drives and one 2 GB drive into an array, the total capacity of the array is 1 GB times 4, or 4 GB, not the 5 GB physically available. Similarly, if you group three 2 GB drives and one 1 GB drive into an array, the total capacity of that array is 4 GB, not the 7 GB physically available.

- A hot-spare drive is a disk drive that is defined for automatic use in the event of a drive failure. The hot-spare drive must be of equal or greater capacity than the drive that it is intended to replace. If a physical drive fails and it is part of a RAID level-1 or RAID level-5 logical drive, the ServeRAID controller automatically starts to rebuild the data on the hot-spare drive.
- You can include a maximum of 16 physical drives in an array when the stripe-unit size is set to 8 KB (the default setting) or 16 KB, and you can include a maximum of 8 physical drives in an array when the stripe-unit size is set to 32 KB or 64 KB. (See “Interleave Depth and Stripe-Unit Size” on page 5 and page 46 for more information.)

Using Custom Configuration

To use the Custom Configuration path:

1. Click on the ServeRAID controller that you want to configure in the Main Tree.
2. Click on the **Custom Configuration** radio button.
3. Click on the **Next** button.

³ When referring to hard-disk-drive capacity, GB means approximately 1 000 000 000 bytes; total user-accessible capacity may vary depending on operating environment.

4. Using the right mouse button, click on the drive or SCSI Channel icons in the Main Tree to select the drives that you want to add to your arrays, delete from your arrays, or define as hot-spare drives; then, select a choice from the pop-up list.

or

Drag the drive or SCSI Channel icon from the Main Tree and drop it on the Array or Hot-Spare Drive icon in the Main Panel on the right. If you change your mind, you can drag the icons back to the Main Tree to remove them from the configuration.

5. After you select the data drives for your arrays and define your hot-spare drives, click on the **Next** button.

If you change your mind, you can:

- Remove a specific drive from a newly defined array or delete an entire newly defined array. To do this, click on the **Back** button, use the right mouse button to click on the specific drive or Array icon in the Main Panel on the right, and then select **Remove from New Array** or **Delete New Array**.
 - Remove a specific hot-spare drive or all newly defined hot-spare drives. To do this, click on the **Back** button, use the right mouse button to click on the Hot-Spare Drive icon in the Main Panel on the right, and then select **Remove New Hot-Spare Drive** or **Remove All New Hot-Spare Drives**.
6. Select a RAID level for the logical drive from the RAID pull-down menu in the Main Panel. (See “Supported RAID Levels” on page 6 for descriptions of the supported levels.)
 7. Move the sliding bar in the Main Panel from right to left to allot data and parity space for the logical drive.

Notes:

- a. You can define from one to eight logical drives.
- b. Some operating systems have size limitations for logical drives. Before you save the configuration, you might want to verify that the size of the logical drive is appropriate for your operating system. See your operating-system documentation for more detailed information.

- c. Typically, the first logical drive defined on the first ServeRAID adapter or controller found by system BIOS during startup will be your startup (boot) drive.
8. If free space is available and you want to define another logical drive, click on the **Add Logical Drive** button in the Main Panel.
9. Repeat steps 6, 7, and 8 for each logical drive that you want to define; then, continue with step 10.
10. Click on the **Next** button.
11. Review the information that appears on the Configuration Summary screen.
Note: To change the configuration, click on a **Modify** icon button.
12. Click on the **Apply** button to accept and save the configuration.
13. If you have not already done so, install your operating system. See the server documentation or the documentation provided with your operating system for more information.

After you install your operating system, see Chapter 4, “Installing Device Drivers and Utility Programs” on page 57 (or the installation instructions provided with your server) for information about installing the ServeRAID device drivers and utility programs.

Using the Information Mode

You can use the Information mode to view the configuration information for the server, ServeRAID controllers, arrays, logical drives, hot-spare drives, and physical drives that make up your ServeRAID subsystem. You also can use this mode to change some of the ServeRAID controller settings.

Viewing the Device and Configuration Information

To view the current settings:

1. Click on the plus (+) box next to the object in the Main Tree to expand that portion of the tree.
2. Click on the icon for the server, ServeRAID controller, array, logical drive, hot-spare drive, or physical drive to view its current settings.

Detailed information about the selected device will appear in the Main Panel on the right. The following pages provide descriptions of the device information that might appear.

System Information Panel

When you select the server from the Main Tree, the following information appears in the Main Panel on the right:

- **System Name** shows the name you assigned to the server.
- **Number of Controllers** shows the total number of ServeRAID adapters and controllers found in the server.

ServeRAID Controller Information Panel

When you select a ServeRAID controller from the Main Tree, the following information appears in the Main Panel on the right:

- **Controller Type** shows the type of ServeRAID controller, such as ServeRAID II, ServeRAID-3H, or ServeRAID-3L.
- **BIOS Version** shows the level of basic input/output system code currently installed for the ServeRAID controller.
- **Firmware Version** shows the level of microcode currently installed for the ServeRAID controller.
- **Physical Slot** shows the actual physical slot location for the ServeRAID controller; for example, PCI slot 4.

- **Battery Backup Write Cache** provides information about the optional battery-backup cache device. Statements such as Installed, Not Installed, Defective, or Replace Battery might appear for this feature.
- **Read-Ahead Cache Mode** shows the current setting, Enabled or Disabled, for the read-ahead cache mode. (See page 45 for more information.)
- **Stripe-Unit Size** shows the current setting of 8 KB, 16 KB, 32 KB, or 64 KB for the stripe-unit size. (See “Interleave Depth and Stripe-Unit Size” on page 5 and page 46 for more information.)
- **Rebuild Rate** shows the current setting (High, Medium, or Low) for the rebuild rate. (See page 45 for more information.)
- **Hot-Swap Rebuild** shows the current setting, Enabled or Disabled, for the hot-swap rebuild feature. This feature is set to Enabled when the level of ServeRAID firmware in use supports this feature.
- **Data Scrubbing** shows the current setting, Enabled or Disabled, for the data-scrubbing feature. This feature is set to Enabled when the level of ServeRAID firmware in use supports this feature. The data-scrubbing feature continuously reads all sectors of RAID level-1 and RAID level-5 logical drives “in the background” while your system is running. If a defective sector is found, it is automatically repaired. With this feature Enabled, you no longer need to synchronize RAID level-1 and RAID level-5 logical drives on a weekly basis.
- **Auto-Synchronization** shows the setting for this feature. The auto-synchronization feature always appears as Enabled when the level of ServeRAID firmware in use supports this feature. (See page 48 for more information.)
- **Clustering** shows the current setting, Enabled or Disabled, for this feature.
- **ServeRAID Controller Host ID** appears only when the controller is part of a shared-disk cluster.
- **Cluster Partner Host ID** appears only when the ServeRAID controller is configured for use in a shared-disk cluster.

- **Number of Arrays** shows the total number of arrays (1 to 8) defined for this ServeRAID controller.
- **Number of Logical Drives** shows the total number of logical drives (1 to 8) defined for this ServeRAID controller.
- **Number of Hot-Spare Drives** shows the total number of hot-spare drives defined for this ServeRAID controller.

Array Information Panel

When you select the Arrays icon from the Main Tree, general information about all configured arrays (such as size, free space, and number of logical drives in each array) appears in the Main Panel on the right.

When you select a specific array from the Main Tree, the following information appears in the Main Panel on the right:

- **Array Letter** shows the letter (A through H) assigned to the array.
- **Array Size in MB** shows the total size, in MB, of the array.
- **Free Space in MB** shows the amount of free space available in the array.
- **Number of Logical Drives** shows the number of logical drives (1 to 8) defined for the array.
- **Number of Physical Drives** shows the number of physical drives grouped in the array.

Logical Drive Information Panel

When you select a logical drive from the Main Tree, the following information appears in the Main Panel on the right:

- **Logical Drive Number** shows the number (1 to 8) assigned to the logical drive.
- **Array Letter** shows the letter (A through H) assigned to the array in which the logical drive resides.

- **Drive State** shows the current state of the logical drive. See “Logical Drive State Descriptions” on page 37 for descriptions of the states that might appear in this field.
- **RAID Level** shows the RAID level (0, 1, or 5) assigned to the logical drive.
- **Data Space in MB** shows the amount of space in the logical drive defined for data storage.
- **Parity Space in MB** shows the amount of space in the logical drive allocated for parity storage.
- **Date Created** shows the date that you created the logical drive.
- **Write-Cache Mode** shows the current setting, write through or write back, for the logical drive.
- **Battery Backup Write Cache** shows the current setting, Enabled or Disabled, for the battery backup cache device. When the battery backup cache device is installed, write cache is set to the write-back mode.
- **Merge-Group Number** appears if the ServeRAID controller is part of a cluster. The valid settings in the Shared state are 1 through 8. Valid settings in the Non-Shared state are 201 through 215.
- **Merge-Group State** shows the current setting, Shared or Non-Shared, for this parameter.

Hot-Spare Drive Information Panel

When you select the Hot-Spare Drives icon from the Main Tree, information about the total number of functional hot-spare and standby hot-spare drives defined for the ServeRAID controller appears in the Main Panel on the right.

When you select a specific hot-spare drive from the Main Tree, the following information appears in the Main Panel on the right:

- **SCSI ID** shows the SCSI ID assigned to the drive.

- **Channel** shows the SCSI channel to which the hot-spare drive is attached.
- **Drive Type** shows the type of physical drive. For a hot spare, this will always appear as Hard Disk Drive.
- **Size in MB** shows the total capacity of the hard disk drive in MB.
- **Drive State** shows the drive state. For a hot spare, this will always appear as Hot Spare.
- **Vendor** shows characters that represent the drive manufacturer.
- **Product or Model Number** shows characters that represent the product or model number for the drive.
- **Serial Number** shows the serial number for the drive.
- **Drive Firmware Level** shows the current level of microcode in use for the drive.
- **PFA Error** indicates the status, Yes or No, for predictive-failure alerts. Yes indicates that PFA errors were detected and that you should plan to replace the device. No indicates that PFA errors were not found.

Physical Drive Information Panel

When you select the Physical Drives icon from the Main Tree, information about the total number of drives connected to each channel of the ServerRAID adapter or controller appears in the Main Panel on the right.

When you select a specific physical drive from the Main Tree, the following information appears in the Main Panel on the right:

- **SCSI ID** shows the SCSI ID assigned to the drive.
- **Channel** shows the SCSI channel to which the physical drive is attached.
- **Drive Type** shows the type of physical drive (Hard Disk, CD-ROM, Tape, Enclosure, Removable-Media, or Unknown) selected.

- **Size in MB** shows the total capacity of the drive, in MB, if the drive is a hard disk. No value will appear if the physical drive is a CD-ROM or Tape drive.
- **Drive State** shows the current state of the physical drive. See “Physical Drive State Descriptions” on page 38 for descriptions of the states that might appear in this field.
- **Array Letter** shows the letter (A through H) assigned to the array in which the physical drive resides, if the physical drive is part of an array.
- **Vendor** shows characters that represent the drive manufacturer.
- **Product or Model Number** shows characters that represent the product or model number for the drive.
- **Serial Number** shows the serial number for the drive.
- **Drive Firmware Level** shows the current level of microcode in use for the drive.
- **PFA Error** indicates the status, Yes or No, for predictive-failure alerts. Yes indicates that PFA errors were detected and that you should plan to replace the device. No indicates that PFA errors were not found.

Channel Information Panel

When you select a SCSI Channel icon from the Main Tree, the following information appears in the Main Panel on the right:

- **Number of Drives** shows the number of physical drives currently attached to the SCSI channel.
- **SCSI Initiator ID** shows the initiator ID for the SCSI channel.
- **SCSI Transfer Speed** shows the current SCSI transfer setting (Optimal, Ultra2 SCSI, UltraSCSI, Fast SCSI 2, or SCSI 2) for the entire channel. See page 49 for more information.

Drive States

This section provides descriptions of the logical and physical drive states.

Logical Drive State Descriptions: The following table provides descriptions of the valid logical drive states.

Drive State	Meaning
Blocked	<p>During a rebuild operation, the ServeRAID controller sets the state of any RAID level-0 logical drives associated with a failed array to the Blocked state; then, it reconstructs the data that was stored in RAID level-1 and RAID level-5 logical drives.</p> <p>After the Rebuild operation completes, you can unblock the RAID level-0 logical drives, and access them once again. However, the logical drive might contain damaged data. You must either re-create, install, or restore the data from the most recent backup disk or tape to the RAID level-0 logical drive.</p>
Critical Migrating	A logical drive in the critical state that is undergoing a logical drive migration (LDM).
Critical System	The ServeRAID controller uses this reserved state during a logical drive migration (LDM).
Critical	<p>A RAID level-1 or level-5 logical drive that contains a defunct physical drive is in the critical state. A critical logical drive is accessible, despite a physical drive failure.</p> <p>Attention: If the state of the logical drive is critical, replace and rebuild the defunct drive as soon as possible to prevent the loss of data. If a second drive fails before the first rebuild completes, you might lose valuable data. See “Rebuilding a Defunct Drive” on page 159 for more information.</p>

Drive State	Meaning
Migrating	The logical drive is undergoing a logical drive migration; that is, a change in RAID levels, a change in logical drive size, or an increase in free space.
Offline	The logical drive is offline and not accessible. This state occurs if one or more physical drives in a RAID level-0 logical drive is defunct. This state also occurs when two or more physical drives in a RAID level-1 or level-5 logical drive are defunct.
Okay	The logical drive is okay. It is in a good, functional state.
System	The ServeRAID controller uses this reserved state during logical drive migration (LDM).

If the state of the logical drive is critical you must replace and rebuild the defunct drive. See “Rebuilding a Defunct Drive” on page 159 for more information.

Physical Drive State Descriptions: The following table provides descriptions of the valid physical drive states.

Drive State	Meaning
Defunct	<p>A physical hard disk drive in the Online, Hot-Spare, or Rebuild state has become defunct. It does not respond to commands, which means that the ServeRAID controller cannot communicate properly with the drive.</p> <p>A hard disk drive in the Defunct state does not necessarily mean that you need to replace the drive. Before you replace the drive, ensure that:</p> <ol style="list-style-type: none"> 1. All cables are connected properly to the server backplane and to the hard disk drive. Also, check to ensure that all cables inside the server are connected properly. 2. The hot-swap drive trays are seated properly in the drive bay. 3. The termination for each device on the SCSI channel is set properly. 4. Each device on the SCSI channel has its own, unique SCSI ID. <p>If the hard disk drive still does not function after you perform these steps, replace the drive.</p>
Empty	No device is present in the bay.
Hot Spare	A Hot-Spare drive is a hard disk drive that is defined for automatic use when a similar drive fails.
Online	The drive is Online. It is functioning properly and is part of an array.
Rebuilding	<p>The drive is being rebuilt.</p> <p>For more information on rebuilding a drive, refer to "Rebuilding a Defunct Drive" on page 159.</p>
Ready	The ServeRAID controller recognizes a Ready drive as being available for definition.
Standby	A Standby drive is a hard disk drive that the ServeRAID controller has spun down.

Drive State	Meaning
Standby Hot Spare	A Standby Hot Spare is a Hot-Spare drive that the ServeRAID controller has spun down. If an Online drive becomes Defunct and no suitable Hot-Spare drive is available, a Standby Hot-Spare drive of the appropriate size automatically spins up, and enters the Rebuild state.

Changing the ServeRAID Configuration Settings

To change the settings:

1. Click on the plus (+) box next to the object in the Main Tree to expand the tree.
2. Click on the icon in the Main Tree for the ServeRAID controller, array, logical drive, hot-spare drive, or physical drive that you want to change.
3. Click on **Actions** in the File Menu; then, make a selection from the pull-down menu.

or

Using the right mouse button, click on the object in the Main Tree; then, make a selection from the pop-up list.

See “Using the Menu Bar” on page 42 for descriptions of the choices available from the Actions pull-down menu.

Using the Tool Bar

Descriptions of the quick-path icons provided on the Tool Bar are as follows:



Save the Configuration Event Log: This icon appears in the Information mode. When you select this icon, a pop-up window appears and lets you specify a file name and path for the ServeRAID Configuration Event Log.

Note: This feature currently is not supported on IBM Netfinity 3000, 3500, 5000, and 5500 servers; however, IBM intends to support this feature on these server models in the near future. The updated BIOS code needed to support this feature will be made available on the World Wide Web. (See page 59 for the instructions needed to access the IBM support page.)

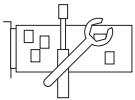

Configure the ServeRAID Controller: This icon appears in the Information mode. When you select this icon, the configuration program switches from the Information mode to the Configuration mode. A message will appear at the bottom of the Main Panel if no Ready drives are available for the selected ServeRAID controller. If this occurs, you can click on the Cancel button to return to the Information mode or select another ServeRAID controller.



Configure for Clustering: This icon appears in the Information mode. You can select this icon to define the ServeRAID controller for use in a dual-node, high-availability, shared-disk cluster environment. Detailed instructions for using the clustering features are provided in the *IBM Netfinity High-Availability Cluster Solution Installation and User's Guide*. You can obtain a copy of this manual at the following address on the World Wide Web:

<http://www.pc.ibm.com/netfinity/clustering>

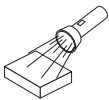

Scan for New or Removed Ready Drives: This icon appears in the Information mode. When you select a ServeRAID controller from the Main Tree and click on this icon, the configuration program will scan the individual channel, or all channels, on the controller for new or removed Ready drives. Use this feature whenever you physically change the configuration of your ServeRAID subsystem, for example, when you physically install or remove one or more SCSI drives.



Create an Array: This icon appears in the Information mode if you select a controller from the Main Tree and that controller has Ready drives available.



Help: This icon appears in both the Information and Configuration modes. Select this icon to access the online ServeRAID Help facility. Task-oriented Help is available from many of the pop-up windows that appear during the configuration process; and, you also can obtain context-sensitive Help by selecting an item and then pressing the **F1** key.

Using the Menu Bar

Descriptions of the choices available from the Menu Bar are as follows:

- File** The File pull-down menu contains the following choices in the Information mode:
- **Save Configuration Event Log:** Select this choice to save configuration event information (such as the start time and completion time for a rebuild operation) to a file.
 - **Clear Configuration Event Log:** Select this choice to erase the event information stored in the Configuration Event Log.
 - **Exit:** Select this choice to exit from the ServeRAID Configuration Program.

View The View pull-down menu contains the following choices in both the Information and Configuration modes:

- **Small Icons:** This is the default setting. When you select this choice, small icons appear in the Main Tree on the left and the Main Panel on the right.
- **Large Icons:** Select this choice to display large icons in the Main Tree on the left and the Main Panel on the right.
- **Options:** Select this choice to change the Initialization and Synchronization mode, as follows:
 - **Basic:** This is the default setting. When this mode is Enabled, the configuration program automatically initializes each new logical drive and prevents access to the manual initialization and synchronization functions. This choice also forces the synchronization of all new RAID level-5 logical drives attached to older ServeRAID adapter or controller models that do not support the auto-synchronization feature.
 - **Advanced:** When Enabled, this choice lets you select to automatically initialize new logical drives and force the synchronization of all new RAID level-5 logical drives before exiting the ServeRAID Configuration Program.

Attention:

If you disable Automatic Initialization, the ServeRAID Configuration Program will not initialize each logical drive (by writing zeros to the first 1024 sectors of the logical drive) when it is created. You still must initialize all newly defined logical drives before storing data. If you disable the synchronization feature and the level of firmware being used by the ServeRAID adapter or controller does not support the auto-synchronization feature, you still must synchronize all RAID level-5 logical drives before storing data.

Actions All choices available from the Actions pull-down menu also are available from the pop-up lists that appear when you use the right mouse button and click on the object in the Main Tree.

The following choices appear on the Actions pull-down menu when you select a ServeRAID controller from the Main Tree:

- **Configure the ServeRAID Controller:** This choice is available in the Information mode only. It appears on the pull-down menu when there are Ready drives and logical-drive slots still available for the ServeRAID controller.
- **Configure for Clustering:** This choice is available in the Information mode only. You can select this choice to define the ServeRAID controller for use in a high-availability, shared-disk cluster environment. Detailed instructions for using the clustering features are provided in the *IBM Netfinity High-Availability Cluster Solution Installation and User's Guide*. You can obtain a copy of this manual at the following address on the World Wide Web:
<http://www.pc.ibm.com/netfinity/clustering>
- **Initialize the Controller Configuration:** This choice is available in both the Configuration and Information modes. Select this choice to delete the ServeRAID controller configuration.

Attention:

After you initialize the controller configuration, you will not have access to any data stored on the logical drives attached to the selected ServeRAID adapter or controller.

This choice deletes the existing configuration information, sets all functional hard disk drives attached to the controller to the Ready state, and deletes all logical drives defined for the controller.

This choice *does not* change any of the ServeRAID adapter or controller settings (such as the stripe-unit size, rebuild rate, and so on) from their current or customized values.

- **Copy the Configuration from the Drives to the Controller:** This choice is available in the Information mode only; it copies the configuration information stored on the hard disk drives to the ServeRAID controller. This function is useful when you import previously configured drives from another system, or when you replace the ServeRAID adapter or controller.
- **Disable or Enable Read-Ahead Cache Mode:** These choices are available in the Information mode only. When read-ahead cache is set to Enabled (default setting), the ServeRAID controller transfers data from a disk to its local cache in increments equal to the stripe-unit size. This provides excellent overall performance when workloads are steady and sequential. However, if the workload is random or the system I/O requests are smaller than the stripe-unit size, reading ahead to the end of the stripe might degrade performance. When read-ahead cache is set to Disabled, the ServeRAID controller transfers data from a disk to local cache in increments equal to the system I/O request size, without reading ahead to the end of the stripe.
- **Change the Rebuild Rate:** This choice is available in the Information mode only. You can select this choice to set the priority for Rebuild operations to High (default), Medium, or Low.
 - When the rebuild rate is set to High, the rebuild I/O request gets high priority in the execution order.
 - When the rebuild request is set from High to Medium in a heavily loaded system, it can increase the rebuild time, but provide better system performance.

- When the rebuild request is set from High or Medium to Low in a moderate to heavily loaded system, it can increase the disk rebuild time, but provide better system performance.
- **Change the Stripe-Unit Size:** This choice is available in the Information mode only.

Attention:

After you configure an array and store data on the logical drives, you cannot change the stripe-unit size without destroying data in the logical drives.

The stripe-unit size is the amount of data written on a given disk before writing on the next disk. To maximize the overall performance, choose a size that is close to the size of the system I/O request. You can set the stripe-unit size to 8 KB, 16 KB, 32 KB, or 64 KB. When the stripe-unit size is 8 KB (the default setting) or 16 KB, the maximum number of physical drives supported in an array is 16. When the stripe-unit size is 32 KB or 64 KB, the maximum number of physical drives supported in an array is eight. (See “Interleave Depth and Stripe-Unit Size” on page 5 for more information.)

- **Scan for New or Removed Ready Drives:** This choice is available in the Information mode only. When you select this choice, the configuration program scans all channels on the ServeRAID controller for new or removed Ready drives.

The following choices appear on the Actions pull-down menu when you select the Arrays icon or a specific array icon from the Main Tree:

- **Create an Array:** This choice appears in the Information mode if you select the Arrays icon and Ready drives are available. When you select this choice, the configuration program switches from the Information mode to the Configuration mode.
- **Delete All Arrays:** This choice is available in the Information mode only. It appears on the Actions

pull-down menu if you select the Arrays icon from the Main Tree and arrays are defined for the controller.

- **Delete Array:** This choice is available in the Information mode only. It appears on the Actions pull-down menu when you select a specific array icon from the Main Tree.

The following choices appear on the Actions pull-down menu when you select the Logical Drives icon or a specific logical drive icon from the Main Tree:

- **Create a Logical Drive in Array:** This choice appears on the Actions pull-down menu in the Information mode if you select the Logical Drives icon and free space is available in one or more arrays.
- **Change Write-Cache Mode to Write Through or Write Back:** These choices are available in the Information mode when you select a specific logical drive icon from the Main Tree.

When this feature is set to the write-through mode, the completion status of a write command is sent *after* the data is written to the hard disk drive. Under certain workloads, you can improve performance by changing this setting to the write-back mode, where the completion status of a write command is sent *after* the data is copied to cache memory, but *before* the data is actually written to the storage device.

Attention:

1. You might lose data if a power outage occurs while using the write-back mode without a battery-backup cache device.
2. If you do not have a battery-backup cache installed and Enabled and you set this feature to the write-back mode, wait at least 10 seconds after your last operation before you turn off your system. Failure to follow this practice can result in lost data.

- **Synchronize:** This choice is available in the Information mode when you select a logical drive from the Main Tree and the following conditions are both true:
 - The ServeRAID adapter or controller does not support the auto-synchronization feature.
 - You previously selected Options from the View pull-down menu and disabled the “Synchronize all new RAID level-5 logical drives” setting.

Synchronizing a logical drive verifies that the data redundancy for the logical drive is correct. You must synchronize all RAID level-5 logical drives before storing data. (See page 32 for more information.)

- **Initialize:** This choice is available in the Information mode when you select a logical drive from the Main Tree and you previously selected Options from the View pull-down menu and disabled the “Automatically initialize new logical drives” setting.
- **Unblock the Logical Drive:** This choice appears in the Information mode when you select a specific logical drive that is in the Blocked state. You can select this choice to change the Drive Access setting for the RAID level-0 logical drive from Blocked to Unblocked. During a rebuild operation, the ServeRAID controller sets the state of any RAID level-0 logical drives associated with a failed array to the Blocked state.

After the Rebuild operation completes, you can unblock the RAID level-0 logical drives, and access them once again. However, the logical drive might contain damaged data. You must either re-create, install, or restore the data from the most recent backup disk or tape to the RAID level-0 logical drive.

The following choice appears on the Actions pull-down menu when you select a hot-spare drive from the Main Tree:

- **Remove from Hot-Spare State:** This choice is available in the Information mode only. Select this choice to remove a hot-spare drive from the configuration and set the drive state back to Ready.

The following choices appear on the Actions pull-down menu when you select a physical drive, a physical drive icon, or a SCSI channel icon from the Main Tree:

- **Set Drive State to Hot Spare:** This choice is available in the Information mode only. It appears when the physical drive that you select from the Main Tree is in the Ready state. You can select this choice to add the drive to the configuration and to change its state from Ready to Hot Spare.
- **Set Drive State to Online:** This choice appears in the Information mode, and you can use it to change the state of a drive from Defunct to Online.

Attention:

You might lose data by setting a Defunct physical drive that is part of an array to Online.

- **Replace Drive and Rebuild:** This choice is available in the Information mode only. Select this choice when you want to physically remove a defunct drive from the system and install a good drive in its place.
- **Change the SCSI Transfer Speed:** This choice is available in the Information mode only. It appears when you select a SCSI Channel icon. You can select this choice to change the transfer speed from its default value of Optimal. When the transfer speed is set to Optimal, the ServeRAID adapter or controller determines the best transfer speed, based on the types of SCSI drives and storage enclosures in use. Choices available are Ultra2 SCSI, UltraSCSI, Fast SCSI 2, and SCSI 2.

- **Remove Defunct Drive:** This choice appears in the Information mode only. After you physically remove a drive, select this choice to delete the drive information from the configuration.
- **Replace Defunct Drive:** This choice appears in the Information mode only. Select this choice to physically replace a defunct disk drive.

Note: Always replace a defunct drive with a drive of equal or greater capacity.
- **Scan for New or Removed Ready Drives:** This choice is available in the Information mode only. When you select this choice, the configuration program scans the individual channel or all channels on the ServeRAID controller for new or removed Ready drives.

Help

The following choices are available from the Help pull-down menu:

- **Contents:** Select this choice to access the online Help facility. This choice is available in both the Information and Configuration modes. Task-oriented Help is available from many of the pop-up windows that appear during the configuration process; and, you also can obtain context-sensitive Help by selecting an item and then pressing the **F1** key.
- **About:** Select this choice to view the version number and copyright information for the ServeRAID Configuration Program. This choice is available in both the Information and Configuration modes.

Using the ServeRAID Mini-Configuration Program

The ServeRAID Mini-Configuration Program is a quick way to display the current settings for the ServeRAID adapter or controller. You also can use this program to perform a limited set of the configuration functions without using the *ServeRAID Configuration CD*.

To access the Mini-Configuration program:

1. Turn on the server. If the server already is turned on, press **Ctrl+Alt+Del**.
2. When the ServeRAID Mini-Configuration prompt appears, press **Ctrl+i**.
3. If your system contains more than one ServeRAID adapter or controller, a selection screen will appear. To continue:
 - a. Use the Up Arrow (↑) or Down Arrow (↓) key to select an adapter or controller.
 - b. Press **Enter**.

If your system contains only one ServeRAID adapter or controller, or after you select a ServeRAID adapter or controller, the Main Menu appears.

Descriptions of the choices available from the Main Menu of the Mini-Configuration program are as follows:

- **View Controller Status** shows the current status of the ServeRAID adapter or controller. (See “Viewing the Controller Status” on page 52 for more information.)
- **View Configuration** shows the current configuration information for the ServeRAID adapter or controller. (See “Viewing the Configuration” on page 53 for more information.)
- **Advanced Functions** lets you initialize the configuration, import configuration from drives, configure BIOS settings, and view the controller and PCI information. (See “Using the Advanced Configuration Functions” on page 53 for more information.)

4. Use the Up Arrow (↑) or Down Arrow (↓) key to highlight your choice; then, press **Enter**.
5. Follow the instructions that appear on the screen.
6. Click on **Exit** to leave the Main Menu.

Viewing the Controller Status

When you select View Controller Status from the Main Menu, the following information appears on the screen:

- **Unattended** shows the current On/Off state of the Unattended mode.
 - When set to Off, you can choose the recovery method when there is a ServeRAID adapter or controller startup error.
 - When set to On, the ServeRAID adapter or controller chooses the recovery method when a startup error occurs.
- **Read Ahead** shows the current On/Off state of the Read Ahead Cache mode.
- **BootCD** shows the current On/Off state of the Bootable CD-ROM function. (Refer to “Setting the Bootable CD-ROM Feature” on page 55.)
- **CompMode** shows the current BIOS compatibility mode. **On** indicates 8 GB Extended; **Off** indicates 2 GB Limited.
- **Clustered** shows the current On/Off state for clustering.
- **NVRBB** shows the current state of the battery-backup cache option. The default value is Enabled.
- **Boot Blk** shows the version number of the bootable microcode loaded for the ServeRAID adapter or controller.
- **Code Blk** shows the current version number of the firmware loaded for the ServeRAID adapter or controller.
- **Rebuild Rate** shows the current speed setting for rebuilds: High, Medium, or Low.
- **Number of Defunct Drives** shows the current number of Defunct physical drives.

- **Number of Offline Drives** shows the current number of Offline logical drives.
- **Number of Critical Drives** shows the current number of Critical logical drives.
- **Config. Updates** shows the number of times that the configuration has been changed since it has been initialized. When you initialize the configuration, the Config. Update resets to zero.
- **Flash Prgms** shows the current number of times that the Flash EEPROM has been written.
- **Locked, Bad Stripe, or Blocked Drive** identifies the logical drives that are affected.
 - **Bad Stripe Drives** indicates the area of a logical drive that is inaccessible.
 - **Locked Stripe Drives** is a reserved field.
 - **Blocked Drives** indicates the logical drives that are blocked. You must unblock a blocked drive before you can use it. See “Logical Drive State Descriptions” on page 37 for more information.

Viewing the Configuration

You can select View Configuration from the Main Menu to view the number of each logical drive, and to view the size, RAID level, state, stripe-unit size, write policy, read-ahead status, and creation date for each logical drive.

Using the Advanced Configuration Functions

You can select the Advanced Functions choice to reset the ServeRAID adapter or controller, initialize the configuration, import the configuration information from the drives, configure BIOS settings, and view the adapter, controller, or PCI information.

When you select the Advanced Functions choice from the Main Menu, the following choices appear on the screen.

Attention:

Be careful when making selections from this menu. If you change the configuration, you might lose data.

- **Initialize Configuration** lets you reset the configuration. You will not have access to any data stored on the logical drives attached to the selected ServeRAID adapter or controller.

This choice deletes the existing configuration information, sets all functional hard disk drives attached to the controller to the Ready state, and deletes all logical drives defined for the controller.

This choice *does not* change any of the ServeRAID adapter or controller settings (such as the stripe-unit size, rebuild rate, and so on) from their current or customized values.

- **Import Configuration from Drive** reads the most common configuration from the drives in the system and copies it to the ServeRAID adapter or controller NVRAM and EEPROM module.
- **Configure BIOS Settings** lets you modify the BIOS settings, such as the Bootable CD-ROM and INT13 Extensions settings, for the ServeRAID adapter or controller. (See “Setting the Bootable CD-ROM Feature” on page 55 for more information.)

Notes:

1. The Multiple Controller mode has two settings: Erase and Shrink. When this parameter is set to Erase, redundant copies of the ServeRAID BIOS are erased. When this parameter is set to Shrink, the extra copies of the ServeRAID BIOS are removed from memory, but stored for future use. When you have multiple ServeRAID adapters and controllers installed, you need only one active copy of ServeRAID BIOS. However, to ensure that you will have a copy of the ServeRAID BIOS available if your active copy becomes defective or unavailable, leave the Multiple Controller parameter set to Shrink.
2. Only one adapter or controller in the system can support the INT13 extensions.

- **View Controller and PCI Information** shows the ServeRAID adapter or controller hardware and PCI register information.
- **Exit** lets you exit the Mini-Configuration program.

Setting the Bootable CD-ROM Feature

When you attach a CD-ROM drive to the ServeRAID adapter or controller and set the Bootable CD-ROM feature to Yes, the ServeRAID adapter or controller will attempt to start a CD that has a bootable startup partition, if no other adapter or controller in the system is currently using INT13 extensions. Only one adapter or controller in the system can support the INT13 extensions.

To enable the Bootable CD-ROM feature:

1. Select **Advanced Functions** from the Main Menu of the Mini-Configuration program.
2. Select **Configure BIOS Settings** from the Advanced Functions menu.
3. Use the Up Arrow (↑) and Down Arrow (↓) keys to highlight **BIOS Support for Bootable CD-ROM**; then, press **Enter** to change No to Yes.

Note: This also changes No to Yes next to **Display Boot CD-ROM Menu** and **BIOS Support for INT13 Extensions**.

4. Ensure that the screen has Yes next to **BIOS Support for Reading Partition Tables**. If not, use the Up Arrow (↑) and Down Arrow (↓) keys to highlight **BIOS Support for Reading Partition Tables**; then, press **Enter** to change No to Yes.

Note: You must perform this next step to save the new settings.

5. Highlight **Save Configuration to the ServeRAID Controller**; then, press **Enter**. The program displays a Configuration Saved message, and then returns you to the Main Menu of the Mini-Configuration program.
6. Press **Ctrl+Alt+Del** to restart the system.

Chapter 4. Installing Device Drivers and Utility Programs

This chapter provides information about the device drivers and utility programs provided on the *IBM ServeRAID Configuration CD* and diskettes that come with the IBM ServeRAID-3L and ServeRAID-3H adapters.

If you are installing files for an IBM ServeRAID controller that came as a standard feature on your IBM Netfinity or PC Server system board, use the installation instructions and CDs provided with your server to install these files.

This chapter contains:

IBM ServeRAID Configuration CD and Diskettes	59
Administration and Monitoring Program	60
Programs for Windows NT and Windows 95	61
Background-Server Components	62
Programs for OS/2 and NetWare	62
Programs for OpenServer and UnixWare	63
Installing the ServeRAID WIN32-Based Program	63
Installing ServeRAID Device Drivers	65
Installing Device Drivers for Windows NT	65
Installing the Files while Installing Windows NT	66
Installing the Files after Installing Windows NT	66
Installing the Background-Server Component for Windows NT	67
Installing Device Drivers for NetWare	69
Installing the Files while Installing NetWare 3.12	69
Installing the Files after Installing NetWare 3.12	70
Installing the Files while Installing NetWare 4.1X	71
Installing the Files after Installing NetWare 4.1X	72
Installing Device Drivers for OS/2	74
Installing the Files while Installing OS/2	74
Installing the Files after Installing OS/2	76
Starting the Administration and Monitoring Program	77
Installing Device Drivers for OpenServer	78
Installing the Files for OpenServer	78
Using an IDE CD-ROM Drive to Install OpenServer Files	81

Installing the Files for OpenServer 5.0.0	81
Installing the Files for OpenServer 5.0.2 and 5.0.4	81
Installing Device Drivers for UnixWare	82
Installing the Files while Installing UnixWare	87
Installing the Files after Installing UnixWare	87
Starting the Background-Server Components	88
Using the Background-Server Components	89
Using the Command-Line Parameters	90
Logging Messages	91
Background-Server Component Security	91
Background-Server Component Name Resolution	92
IPSSSEND and IPSSMON Programs	92
Installing IPSSSEND and IPSSMON for OS/2, Windows NT, or NetWare	93
Installing IPSSSEND and IPSSMON for OpenServer	95
Installing IPSSSEND and IPSSMON for UnixWare	95
Installing IPSSSEND for DOS	96

IBM ServeRAID Configuration CD and Diskettes

This section contains information about the ServeRAID device drivers and utility programs provided in the ServeRAID Support Package, which comes with the ServeRAID-3H and ServeRAID-3L adapters. The support package contains the *IBM ServeRAID Configuration CD* and two diskettes.

IBM periodically makes updated versions of the ServeRAID device drivers and utility programs available from the IBM Support page on the World Wide Web. In addition to the updated device drivers and utility programs, there are also two ServeRAID command-line programs, IPSEND and IPSMON, available from the World Wide Web. These programs are both on the *IBM ServeRAID Command Line Programs Diskette*.

You can download the most current versions of the ServeRAID device drivers and utility programs or a copy of the *IBM ServeRAID Command Line Programs Diskette* from the following address on the World Wide Web:

<http://www.pc.ibm.com/support>

From the IBM Support page:

1. Select **IBM Server Support**; then, select **Server Options** from the Family menu.
2. Select **Downloadable Files**; then, select **ServeRAID**.

(See Chapter 7, "Getting Help, Service, and Information" on page 161 for more information.)

Note: If you do not have access to the World Wide Web, contact your place of purchase, your IBM reseller, or your IBM marketing representative for replacement CDs or diskettes.

The *IBM ServeRAID Configuration CD* contains the following:

- ServeRAID Configuration Program. This program runs when you start (boot) the CD.
- ServeRAID Administration and Monitoring Program. These program files are in the /PROGRAMS/DISK3 directory. See

“Administration and Monitoring Program” on page 60 for more information.

- ServeRAID files needed to install Microsoft Cluster Server (MSCS) when using Windows NT and an IBM ServeRAID II Ultra SCSI Adapter or an IBM ServeRAID-3H Ultra2 SCSI Adapter. These files are in the /PROGRAMS/DISK5 directory on the *IBM ServeRAID Configuration CD*. Detailed instructions for installing and using these files are provided in the *IBM Netfinity High-Availability Cluster Solution Installation and User's Guide*. You can obtain a copy of the *IBM Netfinity High-Availability Cluster Solution Installation and User's Guide* from the following World Wide Web address:

<http://www.pc.ibm.com/netfinity/clustering>

The *IBM ServeRAID Device Driver Diskette* contains the following:

- DOS CD-ROM drive device drivers
- Device Drivers and the background-server component for Microsoft Windows NT
- Device Drivers, Administration and Monitoring Program, and the background-server components for OS/2 Warp Server, OS/2 LAN Server, Novell NetWare 3.12, and Novell NetWare 4.1X

The *IBM ServeRAID Device Drivers for SCO Operating Systems Diskette* contains the following:

- Device drivers and the background-server component for SCO OpenServer 5.0.0, 5.0.2, and 5.0.4.
- Device Drivers and background-server component for SCO UnixWare 7.0

Administration and Monitoring Program

The IBM ServeRAID Administration and Monitoring Program monitors your ServeRAID adapters and controllers while your network operating system is up and running.

This section provides information about the IBM ServeRAID

Administration and Monitoring Program files provided with the ServeRAID adapter. You can use these files with the Windows NT, Windows 95, OS/2, Novell NetWare, SCO OpenServer, and SCO UnixWare operating systems.

Programs for Windows NT and Windows 95

The ServeRAID program files available for Windows NT consist of the ServeRAID Administration and Monitoring Program, device drivers, background-server components, and the IPSEND and IPSMON command-line programs. (See "IPSEND and IPSMON Programs" on page 92 for more information.)

The IBM ServeRAID Administration and Monitoring Program for Microsoft Windows NT or Windows 95 is called the WIN32-Based program. This program provides a graphical interface that enables you to monitor ServeRAID configuration changes being performed on your server while your server is fully operational. You can create an array, delete an array, create a logical drive, change the RAID level, dynamically increase the logical drive size, rebuild an array, and perform other basic ServeRAID configuration functions.

You can run the WIN32-Based program in the stand-alone mode *only* on a Windows NT server. Or, you can run the WIN32-Based program remotely on a Windows NT or Windows 95 client and access the client from a server that has TCP/IP, a background-server component (see "Background-Server Components" on page 62), and one of the following operating systems installed:

- Microsoft Windows NT
- IBM OS/2 Warp Server and OS/2 LAN Server
- Novell NetWare 3.12 and 4.1X
- SCO UnixWare 7.0
- SCO OpenServer 5.0.X

Background-Server Components

The background-server components are operating-system specific program files that enable servers running Windows NT, OS/2, NetWare, OpenServer, or UnixWare to act as the TCP/IP interface for a remote client that has the WIN32-Based program installed.

Notes:

1. Only one remote session at a time can access ServeRAID adapters and controllers using the background-server component.
2. It is possible to run multiple background-server components with each component using a different TCP/IP port; however, to avoid damage to your data, you must restrict your administration activities to one remote client and use the other remote clients for monitoring purposes only.

Programs for OS/2 and NetWare

The ServeRAID program files available for the OS/2 and NetWare operating systems consist of the Administration and Monitoring program, device drivers, background-server components, and the IPSEND and IPSMON command-line programs. (See "IPSEND and IPSMON Programs" on page 92 for more information.)

The Administration and Monitoring Program files for OS/2 and NetWare run only on the system containing a ServeRAID adapter or controller (stand-alone mode). These ServeRAID programs provide a limited subset of the functions provided in the WIN32-Based program, and they install automatically when you install the ServeRAID device driver for OS/2 or NetWare.

A good way to use these operating-system specific programs is to run the OS/2 or NetWare versions of the Administration and Monitoring Program files locally on the server, while using the WIN32-Based program on a remote Windows NT or Windows 95 client. This method enables you to take advantage of the more advanced administration and monitoring functions provided in the WIN32-Based program.

Programs for OpenServer and UnixWare

The ServeRAID program files available for OpenServer and UnixWare consist of device drivers, background-server components, and the IPSSSEND and IPSMON command-line programs. (See “IPSSSEND and IPSMON Programs” on page 92 for more information.)

The background-server components for SCO operating systems install automatically when you install the ServeRAID OpenServer or UnixWare device drivers.

To use the ServeRAID Administration and Monitoring Program with a SCO operating system, you must first install the WIN32-Based program on a Windows NT or Windows 95 client. Then, attach the Windows NT or Windows 95 client to the same network as the OpenServer or UnixWare system that contains the ServeRAID adapter or controller. You must perform all administration functions from the remote WIN32-Based client.

Installing the ServeRAID WIN32-Based Program

This section provides instructions for installing the ServeRAID WIN32-Based program.

Before you begin the installation.

- Be sure that your ServeRAID adapter or controller is physically installed, properly cabled, and configured.
- Be sure that your network operating system is installed and functional.
- If your network operating system is Windows NT, you can use the ServeRAID WIN32-Based program remotely in the client/server mode or locally in stand-alone mode. Use the instructions in this section and in “Installing ServeRAID Device Drivers” on page 65 to install the ServeRAID files.
- The ServeRAID adapters and controllers do not support Windows 95. However, you can run the WIN32-Based program remotely on a Windows 95 client attached to a remote server

running the OS/2, NetWare, Windows NT, UnixWare, or OpenServer operating system. Use the instructions in this section to install the WIN32-Based program on the Windows 95 client.

- If your network operating system is OS/2, NetWare, OpenServer, or UnixWare, you must run the ServeRAID WIN32-Based program remotely, in the client/server mode.

Other requirements for this environment include:

- A Windows NT or Windows 95 client running the IBM ServeRAID WIN32-Based program

Use the instructions in this section to install the WIN32-Based program.

- A network adapter with proper cabling for access to the remote systems
- The TCP/IP networking protocol installed on both the local and remote systems
- The ServeRAID device driver and background-server component installed on the remote system

Refer to “Installing ServeRAID Device Drivers” on page 65 for more information.

To install the ServeRAID WIN32-Based program:

1. Turn on the system and allow Windows NT or Windows 95 to start.
2. Insert the *IBM ServeRAID Configuration CD* into the CD-ROM drive.
3. Click on **Start**, click on **Run**; then, type the following:

z:\programs\disk3\setup

Note: The z represents the letter assignment for the CD-ROM drive that contains the ServeRAID CD.

4. Press **Enter**; then, follow the instructions that appear on the screen to complete the installation.

Refer to Chapter 5, “Starting and Using the Utility Programs” on page 97 for more information about the WIN32-Based program.

Installing ServeRAID Device Drivers

This section provides the instructions for installing the device drivers for Windows NT, NetWare, OS/2, OpenServer, and UnixWare.

If you are using Windows NT, you must use the instructions provided in “Installing the Background-Server Component for Windows NT” on page 67 to install the Windows NT background-server component *after* you install the ServeRAID device driver.

The OS/2 and NetWare Administration and Monitoring Program files and background-server components install automatically when you install the ServeRAID device drivers for OS/2 and NetWare. The UnixWare and OpenServer background-server components install automatically when you install the ServeRAID device drivers for UnixWare and OpenServer.

When using:	Go to:
Windows NT	“Installing Device Drivers for Windows NT”
NetWare	“Installing Device Drivers for NetWare” on page 69
OS/2	“Installing Device Drivers for OS/2” on page 74
OpenServer	“Installing Device Drivers for OpenServer” on page 78
UnixWare	“Installing Device Drivers for UnixWare” on page 82

Installing Device Drivers for Windows NT

This section provides two sets of instructions for installing the ServeRAID device driver: one that you can use during the initial Windows NT installation and one that you can use if Windows NT already is installed.

Follow the instructions in “Installing the Background-Server Component for Windows NT” on page 67 to install the files for Windows NT 3.5X and Windows NT 4.0 after you install the ServeRAID device driver.

Installing the Files while Installing Windows NT

To install the ServeRAID device driver while installing Windows NT:

1. Insert the Windows NT boot diskette into the diskette drive or insert the bootable Windows NT CD into the CD-ROM drive; then, restart the server.
2. When the message Setup is inspecting your computer's hardware configuration... appears, press the **F6** key.
3. After loading some files, Windows NT displays a screen that allows you to manually specify an adapter. When this screen appears, press **S** to specify additional devices.
4. When prompted in the next window, select **Other** from the list.
5. When prompted to insert the Manufacturer-supplied-hardware support disk, insert the *IBM ServeRAID Device Driver Diskette* into the diskette drive; then, press **Enter**.
6. Select **IBM ServeRAID Adapter**; then, press **Enter**. A message similar to the following will appear. Setup is loading files (IBM ServeRAID Adapter)....
7. When prompted, press **Enter** to continue.
8. Use the instructions provided in the Windows NT manual to complete the normal installation process.
9. After you complete the installation, be sure to apply the latest Service Pack.
10. Continue with "Installing the Background-Server Component for Windows NT" on page 67.

Installing the Files after Installing Windows NT

To install the ServeRAID device driver after Installing Windows NT:

1. Insert the *IBM ServeRAID Device Driver Diskette* into the diskette drive.
2. From the Start Menu, select **Settings**; then, select **Control Panel**.
3. Select **SCSI Adapter**; then, click on the **Drivers** tab.

4. Click on **Add**; then, click on **Have Disk**.
5. In the **Copy manufacturer's files from** field, type:
a:\nt
6. Click on **OK**; then in the next dialog box, click on **OK** again.
7. When a message appears asking if you want to use the currently installed device driver or if you want to install a new one, click on **New**.
8. When prompted to enter the full path to the IBM ServeRAID files, type:
a:\nt
9. Click on **Continue**; then after the device driver installs, restart the system.
10. Continue with "Installing the Background-Server Component for Windows NT."

Installing the Background-Server Component for Windows NT

This section provides the instructions needed to install the background-server components for Windows 3.5X and Windows 4.0.

Installing the Background Server Component for Windows 3.5X

1. Insert the *IBM ServeRAID Device Driver Diskette* into the diskette drive; then, type the following to copy the IPSADM.EXE file to your hard disk:
copy a:\nt\ipsadm.exe c:\winnt\system32\ipsadm.exe
2. Press **Enter**.
3. Type the following to copy the IPSADM.ICO icon file to your hard disk:
copy a:\nt\ipsadm.ico c:\winnt\system32\ipsadm.ico
4. Press **Enter**.
5. Select a group or create a new group to store the program. For example, open the Administrative Tools Group or create a new program group named IPSADM Admin-Monitor.

6. Click on **File**, click on **New**, click on **Personal Item**, and then click on **OK**.

7. Type the following information in the data fields:

Description:	IPSRAID Admin-Monitor
Command Line:	C:\WINNT\SYSTEM32\IPSADM.EXE
Working Dir:	C:\WINNT\SYSTEM32

8. Click on **Change Icon**; then, click on **OK** in the information window.

9. In the Change Icon window, type:

c:\winnt\system32\ipsadm.ico

or,

click on **Browse** and select C:\WINNT\SYSTEM32\IPSADM.ICO.

10. Click on **OK** for the icon.

11. Click on **OK** for the Personal Item.

12. Double-click on the new icon to access the Administration and Monitoring Program.

Installing the Background Server Component for Windows 4.0

1. Insert the *IBM ServeRAID Device Driver Diskette* into the diskette drive; then, type the following to copy the IPSADM.EXE file to your hard disk:

```
copy a:\nt\ipsadm.exe c:\winnt\system32\ipsadm.exe
```

2. Press **Enter**.

3. Type the following to copy the IPSADM.ICO icon file to your hard disk:

```
copy a:\nt\ipsadm.ico c:\winnt\system32\ipsadm.ico
```

4. Press **Enter**.

5. Complete the following steps to create a new program shortcut:

a. Using the right mouse button, click on the **Desktop**.

b. Click on **New**; then, click on **Shortcut**.

c. In the Create Shortcut window type:

```
c:\winnt\system32\ipsadm.exe
```

- d. Click on **Next**.
 - e. In the Select a Title for the Program window, type:
IPSRAID Admin-Monitor Server
 - f. Click on **Finish**.
6. Using the right mouse button, click on the **icon**.
 7. Click on **Properties**, click on **Shortcut**, and then click on **Change Icon**.
 8. In the Information window, click on **OK**.
 9. In the Change Icon window, type:
c:\winnt\system32\ipsadm.ico
 10. Click on **OK** for the icon; then, click on **OK** for the program properties.
 11. Double-click on the new icon to access the Administration and Monitoring Program.

Installing Device Drivers for NetWare

This section provides instructions for installing the ServeRAID device drivers while installing NetWare 3.12 or 4.1X, and instructions for installing the ServeRAID device drivers if NetWare 3.12 or 4.1X already is installed.

The Administration and Monitoring Program files and the background-server components for NetWare install automatically when you install the ServeRAID device drivers for NetWare.

Installing the Files while Installing NetWare 3.12

The ServeRAID device driver for NetWare, IPSRAID.HAM, is in the NetWare directory on the *IBM ServeRAID Device Driver Diskette*. You can use the INSTALL.BAT file, which is also in the NetWare directory on the diskette, to copy all required files to your server directory. The INSTALL.BAT file will modify the STARTUP.NCF file so that it will load the required NetWare modules.

Use the instructions provided in the NetWare 3.12 manual along with the following instructions to install the ServeRAID device driver, background-server component, and Administration and Monitoring Program files while installing NetWare, Version 3.12.

1. Type the following at the command prompt to manually create the directory for NetWare:

```
md server.312
```

Note: The *SERVER.312* is the default NetWare 3.12 directory. If you are using a different path, be sure to specify the same path throughout the entire NetWare installation process.

2. Press **Enter**.
3. Change to the *SERVER.312* directory on your hard disk; then, insert the *IBM ServeRAID Device Driver Diskette* into the diskette drive.
4. At the operating-system prompt, type:

```
a:
```

Note: The *a* represents the drive assignment for the diskette drive that contains the ServeRAID diskette.

5. Press **Enter**. Then, type:

```
cd netware
```

6. Press **Enter**. Then, type:

```
install
```

7. Press **Enter**. Then, follow the instructions that appear on the screen to complete the ServeRAID device driver and program installation.

Installing the Files after Installing NetWare 3.12

The ServeRAID device driver for NetWare, *IPSRAID.HAM*, is in the NetWare directory on the *IBM ServeRAID Device Driver Diskette*. You can use the *INSTALL.BAT* file, which is also in the NetWare directory on the diskette, to copy all of the required files to your server directory. The *INSTALL.BAT* file will modify the *STARTUP.NCF* file so that it will load the required NetWare modules.

Use the instructions provided in the NetWare 3.12 manual along with the following instructions to install the ServeRAID device driver, background-server component, and Administration and Monitoring Program files after installing NetWare, Version 3.12.

1. Insert the *IBM ServeRAID Device Driver Diskette* into the diskette drive.
2. Go to the default NetWare 3.12 directory. To do this, type:
`cd\server.312`

Note: The *SERVER.312* is the default NetWare 3.12 directory. If you are using a different path, be sure to specify the same path throughout the installation process.

3. Press **Enter**; then, from the operating-system prompt in the *SERVER.312* directory, type:
a:

Note: The *a* represents the drive assignment for the diskette drive that contains the ServeRAID diskette.

4. Press **Enter**. Then, type:
`cd netware`
5. Press **Enter**. Then, type:
`install`
6. Press **Enter**. Then, follow the instructions that appear on the screen to complete the ServeRAID device driver and program installation.

Installing the Files while Installing NetWare 4.1X

Use the instructions provided in the NetWare 4.1X manual along with the following instructions to install the ServeRAID device driver, background-server component, and Administration and Monitoring Program files while installing NetWare, Version 4.1X.

1. Use the instructions provided in the NetWare manual to begin the installation.

2. When the Choose the Server Drivers - Disk Driver prompt appears during the install process, insert the *IBM ServeRAID Device Driver Diskette* into the diskette drive.
3. Select **Select additional or modify selected Disk/LAN drivers**.
4. If IPSRAID appears, select **Deselect a selected driver**.
5. Select **Select an additional driver**; then, press the **Ins** (Insert) key to add an unlisted new device driver.
6. Press **F3** to specify a path; then, type:
a:\netware
Note: The *a* represents the drive assignment for the diskette drive that contains the ServeRAID diskette.
7. Select **IPSRAID.HAM** from the list of device drivers that appears in the window; then, press **Enter**.
Note: The IPSRAID.HAM and support files will be copied to the system volume.
8. Select **OK** to overwrite the existing files.
9. Follow the instructions in the NetWare manual to complete the installation.

Installing the Files after Installing NetWare 4.1X

1. From the system console, start the NetWare installation utility program by typing:
load install
2. Press **Enter**.
3. Insert the *IBM ServeRAID Device Driver Diskette* into the diskette drive.
4. Select **Driver options** from the Installation Options list.
5. Select **Configure disk and storage** from the Driver Options pop-up window.
6. Select **Select an additional driver** from the Additional Drivers Actions pop-up window.

7. When the next screen appears, press the **Ins** key to install an unlisted driver.
8. When the next screen appears, press the **F3** key to specify a different path.
9. In the **Specify a directory path** field, type:
a:\netware
10. When prompted to select a driver to install, select **IPSRAID.HAM**.
11. Select **Yes** when prompted to copy the IPSRAID.HAM driver.
12. When the prompt appears to specify the server boot path, type:
c:\nwserver

Notes:

- a. This instruction assumes that you installed NetWare in its default directory. If you did not install NetWare in the NWSERVER directory on drive C, modify step 12 accordingly.
 - b. If any of the files you are installing already exist on the server, NetWare will prompt you to save the older files. Although it is not necessary to save the older files, it usually is a good idea.
13. After the installation program copies all files, you can edit parameters (such as the ServeRAID slot number) from the Driver IPSRAID Parameter Actions screen.
 14. After you edit the parameters, select **Save Parameters and load driver** to load the ServeRAID device driver.
 15. Press **Esc** to exit the installation screens.

Note: If you want NetWare to load the ServeRAID device driver automatically during startup, you must add the appropriate LOAD command (for example, load ipsraid.ham slot=1) to the NetWare startup command file (usually C:\NWSERVER\STARTUP.NCF).

Installing Device Drivers for OS/2

This section provides two sets of instructions for installing the ServeRAID device driver: one that you can use during the initial OS/2 installation and one that you can use if OS/2 already is installed.

The ServeRAID Administration and Monitoring Program files and background-server component for OS/2 install automatically when you install the ServeRAID device driver for OS/2.

Installing the Files while Installing OS/2

You can use the following instructions to install the ServeRAID device driver and Administration and Monitoring Program files while installing OS/2 Warp Server.

Note: If you install these files on a logical drive that has its write policy set to the write-back mode, wait at least 10 seconds after being prompted to press **Ctrl+Alt+Del** before you actually press the keys. Waiting 10 seconds or longer gives the ServeRAID adapter or controller the time needed to flush all dirty-cache pages out to the hard disk.

To install the ServeRAID files while installing OS/2:

1. Make a copy of the *OS/2 Warp Diskette 1* and label it *Copy of OS/2 Diskette 1*.
2. Copy the `IPSRAID.ADD` file from the `OS2` directory on the *IBM ServeRAID Device Driver Diskette* to the *Copy of OS/2 Diskette 1*.

If there is not enough space, delete files not needed in your installation (such as proprietary CD-ROM or SCSI device drivers). Make sure you remove all entries referring to any device drivers you delete from the `CONFIG.SYS` file.

3. Edit the `CONFIG.SYS` file on the *Copy of OS/2 Diskette 1* to add the following lines:

```
BASEDEV=IPSRAID.ADD
SET COPYFROMFLOPPY=1
```

4. Install OS/2, but when prompted to insert diskette 1, use the updated *Copy of OS/2 Diskette 1*.

5. After you complete the OS/2 installation, insert the *IBM ServeRAID Device Driver Diskette*.

6. From an OS/2 window, type:

a:

Note: The *a* represents the drive assignment for the diskette drive that contains the ServeRAID diskette.

7. Press **Enter**. Then, type:

```
ddinstal
```

8. Press **Enter**.

The OS/2 Device Driver Installation window will appear and prompt you for the source and destination drives. The source directory shows where to insert the *IBM ServeRAID Device Driver Diskette*. The destination directory shows where the program will copy the device driver files.

9. Click on **Install**.

- The program copies the following ServeRAID device driver and program files to the OS/2 subdirectory on your hard disk: IPSRAID.ADD, IPSADM.EXE, and IPSRADM.EXE.
- The program copies the ServeRAID IPSRADM.HLP Help file to the \OS2\HELP directory.

10. Edit the CONFIG.SYS file and verify that there is only one copy of the line BASEDEV=IPSRAID.ADD.

Notes:

- a. If you have more than one ServeRAID or SCSI adapter in your system, make sure that the BASEDEV statement for the adapter controlling the startup (boot) device appears before the BASEDEV statements for other ServeRAID or SCSI adapters in the CONFIG.SYS file.
- b. After you install any service packs, check the path for the IPSRAID.ADD device driver and verify that the correct device driver is installed.

11. Restart the server.

Installing the Files after Installing OS/2

You can use the following instructions to install the ServeRAID device driver and Administration and Monitoring Program files after installing OS/2 Warp Server.

To install the ServeRAID files after installing OS/2:

1. After you complete the OS/2 installation, insert the *IBM ServeRAID Device Driver Diskette*.
2. From an OS/2 window, type:
 - a:

Notes:

- a. The *a* represents the drive assignment for the diskette drive that contains the ServeRAID diskette.
 - b. If you install these files on a logical drive that has its write policy set to the write-back mode, wait at least 10 seconds after being prompted to press **Ctrl+Alt+Del** before you actually press the keys. Waiting 10 seconds or longer gives the ServeRAID adapter or controller the time needed to flush all dirty-cache pages out to the hard disk.
3. Press **Enter**. Then, type:

```
ddinstal
```
 4. Press **Enter**.

The OS/2 Device Driver Installation window will appear and prompt you for the source and destination drives. The source directory shows where to insert the *IBM ServeRAID Device Driver Diskette*. The destination directory shows where the program will copy the device driver files.

5. Click on **Install**.
 - The program copies the following ServeRAID device driver statement to your CONFIG.SYS file:

```
BASEDEV=IPSRAID.ADD
```

- The program copies the following ServeRAID device driver and program files to the OS/2 subdirectory on your hard disk: IPSRAID.ADD, IPSADM.EXE, and IPSRADM.EXE
 - The program copies the following ServeRAID Help file to the \OS2\HELP directory: IPSRADM.HLP
6. Edit the CONFIG.SYS file and verify that there is only one copy of the line BASEDEV=IPSRAID.ADD.

Notes:

- a. If you have more than one ServeRAID or SCSI adapter in your system, make sure that the BASEDEV statement for the adapter controlling the startup (boot) device appears before the BASEDEV statements for other ServeRAID or SCSI adapters in the CONFIG.SYS file.
 - b. After you install any service packs, check the path for the IPSRAID.ADD device driver and verify that the correct device driver is installed.
7. Restart the server.

Starting the Administration and Monitoring Program

To start the ServeRAID Administration and Monitoring Program for OS/2:

1. Go to the OS/2 subdirectory on the hard disk drive; then, type:

```
ipsradm //f=d:\path\logfile
```

Notes:

- a. Make sure that the path you type exists. The program will not create a path.
 - b. *Logfile* is where the program will log messages.
 - c. If you omit the *//f* parameter, the program will create the *IPSRADM.LOG* default file in the OS2 subdirectory to log the program messages.
2. Press **Enter**.
 3. Use the following steps if you want to define IPSRADM to OS/2:

- a. Open the Templates Folder on the OS/2 Desktop.
- b. Drag a program template onto the Desktop. A Program Settings window will appear.
- c. At the Program page in the **Path and File Name** field, type:
c:\os2\ipsradm.exe
- d. In the **Parameters** field, type:
/lf=d:\path\logfile
- e. At the General Tab in the **Title** field, type:
ServeRAID

Installing Device Drivers for OpenServer

To use the ServeRAID Administration and Monitoring Program with SCO, you must first install the WIN32-Based version of the Administration and Monitoring Program on a Windows NT or Windows 95 client. Then, attach the Windows NT or Windows 95 client to the same network as the OpenServer systems that contain the ServeRAID adapters or controllers. Finally, you must install the ServeRAID device driver and background-server component for OpenServer.

The background-server component for OpenServer installs automatically when you install the ServeRAID OpenServer device driver. This component enables the OpenServer system to act as the TCP/IP interface for the remote WIN32-Based Program. (See "Programs for Windows NT and Windows 95" on page 61 for more information.)

Installing the Files for OpenServer

Before you begin the installation, review the following information:

- You must install logical drives as Bus Number 0 when using the MKDEV program, regardless of the channel that the physical drives are on.
- You must install nondisk devices, such as CD-ROM and tape drives, as Bus Numbers 1, 2, or 3 relative to the channel to

which they are attached. External Channel 1 connector is Bus Number 1, external Channel 2 connector is Bus Number 2, and internal Channel 3 connector is Bus Number 3.

To configure the default nondisk devices during the initial installation:

1. Redefine the default tape drive in the initial bootstring. For example, to install the IPSRAID BTLD and redefine the tape drive, go to the B00T prompt and type:

```
link Stp=ips(0, 1, 2, 0)
```

The numbers in parentheses represent the Host Adapter Number, the Bus Number, the SCSI ID, and the LUN respectively.

2. When prompted for the location of the installation CD, change the Bus Number and SCSI ID, as required.

Adding BTLD at Boot Time: To install the ServeRAID device driver for OpenServer, Version 5.0.X:

1. At the B00T prompt, type:

```
link
```

2. Press **Enter**; then, when asked for the name of the package to load, type:

```
ipsraid
```

3. Press **Enter**.

4. After the kernel loads but before it runs, link prompts you to insert the *IBM ServeRAID Device Drivers for SCO Operating Systems Diskette*.

While the installation program copies the files, one or both of the following messages might appear:

Messages:

- a. Extracting BTLD distribution for ipsraid... /etc/uadmin
getdev b ips: No such device (error 19)
- b. dynamic linker: dlvr_audit: Cannot open /dev/zero for
file /lib/libprot.so.1

You can ignore Message A, no action is required. But if

Message B appears, you must press **Enter** when prompted to continue the installation.

5. Keep the *IBM ServeRAID Device Drivers for SCO Operating Systems Diskette* readily available. You will need it to configure the device driver into the link kit.

For additional information about adding a BTLD at boot time, refer to “Using Boot-Time Loadable Drivers” in the *SCO OpenServer Handbook*.

Adding BTLD after the Initial Installation

1. Start the server in system maintenance mode, and log in as *root*.
2. Type:
`installpkg`
3. Press **Enter**; then, select the diskette drive in which you will insert your installation diskette.
4. Insert the *IBM ServeRAID Device Drivers for SCO Operating Systems Diskette*, when prompted.
5. When prompted for the name of the package, type:

```
ipsraid
```

6. Press **Enter**; then, relink the kernel (as described in “Relinking the kernel” in the *SCO OpenServer Handbook*) by entering the following commands:

```
cd /etc/conf/cf.d  
./link_unix
```

7. After the kernel rebuilds, the following message appears:

```
The UNIX kernel has been rebuilt. Do you want this kernel  
to boot by default?
```

```
To continue, enter: y
```

```
The system backs up the old kernel by moving /UNIX to  
/UNIX.OLD.
```

8. When the system asks for the kernel environment to be rebuilt, enter: *y*

The system will respond with a successful message.

9. Use *shutdown* to bring down the system; then, restart the system.

Using an IDE CD-ROM Drive to Install OpenServer Files

This section contains instructions for installing files for OpenServer 5.0.0, OpenServer 5.0.2, and OpenServer 5.0.4 when using an IDE CD-ROM Drive.

Installing the Files for OpenServer 5.0.0

To install files for OpenServer 5.0.0 using an IDE CD-ROM drive:

1. Type the following at the B00T prompt:
`restart ahslink="ATAPI ipsraid" Srom=wd(0,0,0,0)`
2. Insert the ATAPI BTLD diskette when prompted; then, press **r** to replace the *wd* driver.

The fields for the ATAPI CDROM are:

Srom=wd(*c,d,l,b*) where:

- c = primary (0) or secondary (1) IDE/EIDE controller
- d = master (0) or slave (1) device
- l = LUN of device (always 0 with ATAPI or wd driver)
- b = BUS of device (always 0 with ATAPI or wd driver)

Installing the Files for OpenServer 5.0.2 and 5.0.4

To install files for OpenServer Versions 5.0.2 or 5.0.4 using an IDE CD-ROM drive:

1. Type the following at the B00T prompt:
`restart link=ipsraid Srom=wd(0,0,0,0)`

Note: The ATAPI BTLD (which includes the *wd* driver) is included in OpenServer 5.0.2 and 5.0.4.

The fields for the ATAPI CDROM are:

Srom=wd(*c,d,l,b*) where:

c = primary (0) or secondary (1) IDE/EIDE controller

d = master (0) or slave (1) device

l = LUN of device (always 0 with ATAPI or "wd" driver)

b = BUS of device (always 0 with ATAPI or "wd" driver)

2. Let the system start normally until it comes to the select Media options.

- If you are using OpenServer 5.0.2, go to step 3.
- If you are using OpenServer 5.0.4, go to step 4.

3. To install with OpenServer 5.0.2:

- a. Select Adapter type as **WD**.
- b. Select Media Type as **SCSI CDROM**.
- c. Select ID, BUS and LUN as **0**.
- d. Go to step 5.

4. To install with OpenServer 5.0.4:

- a. Select Media Type as **IDE CDROM Drive**.
- b. Select **Primary Adapter** and **Master Device**.
- c. Go to step 5.

5. You have completed the installation.

Installing Device Drivers for UnixWare

The instructions for installing the ServeRAID files when using UnixWare depend on the number of IDE and SCSI disk-storage adapters and controllers installed in the system. If all of the direct-access-storage devices (DASD) in the system are attached to a single disk-storage adapter or controller (such as the ServeRAID adapter or controller), you can skip the instructions in this section and go directly to "Installing the Files while Installing UnixWare" on page 87 or "Installing the Files after Installing UnixWare" on page 87.

If you are attaching devices to multiple disk-storage adapters or controllers (including IDE and SCSI controllers integrated on the system board), use the following instructions.

- If you are installing UnixWare on a drive attached to a ServeRAID adapter or controller, follow the instructions in “Installing UnixWare on a ServeRAID Drive” on page 83.
- If you are installing UnixWare on a drive attached to a non-ServeRAID adapter or controller and you intend to store only data on the drives attached to your ServeRAID adapters and controllers, follow the instructions in “Installing UnixWare on a Non-ServeRAID Drive” on page 85.

Installing UnixWare on a ServeRAID Drive: Use the following instructions if you are using multiple disk-storage adapters or controllers and you are installing UnixWare on a drive attached to a ServeRAID adapter or controller.

Note: If you are not using multiple disk-storage adapters and controllers, go to “Installing the Files while Installing UnixWare” on page 87.

1. Install all ServeRAID adapters that you intend to use in your system.
2. Using the ServeRAID Configuration Program, create all of your arrays and define all of your logical drives.
3. Make a list of all of the ServeRAID adapters and controllers, including the order and slot number, installed in the system. To do this:
 - a. Turn on the server.
 - b. When the ServeRAID Mini-Configuration prompt appears, press **Ctrl+i**. When a system contains more than one ServeRAID adapter or controller, a selection screen appears.
 - c. The menu lists the ServeRAID adapters and controllers in order. Select the first ServeRAID adapter or controller from the menu.
 - d. Select **Advanced Functions** from the Main Menu.
 - e. Select **View Controller and PCI Information** from the Advanced Functions menu.

- f. Record the slot number for the ServeRAID adapter or controller; then, press **Esc** three times to return to the controller selection screen.
 - g. Repeat step 3c on page 83 through step 3f until you record the slot number for each ServeRAID adapter or controller that appears on the selection screen.
4. Turn off the system; then, remove all ServeRAID adapters and controllers except the first one on your list.

Note: If one of the ServeRAID controllers that you need to remove is on the system board, you must do one of the following:

- If the CD-ROM drive that you are using to install your operating system is attached to the integrated ServeRAID controller, disconnect or remove all disk drives attached to the integrated controller.
- If only disk drives are attached to the integrated controller, disconnect the SCSI cable from the ServeRAID connector on the system board. See the label inside the server cover for the location of the ServeRAID connector.

5. Remove all other non-ServeRAID IDE and SCSI disk-storage adapters and controllers.

Note: If one of the disk-storage controllers that you need to remove is on the system board, you must do one of the following:

- If the CD-ROM drive that you are using to install your operating system is attached to the integrated disk-storage controller, disconnect or remove all disk drives attached to the integrated controller.
- If only disk drives are attached to the integrated controller, disconnect the cable for the integrated controller from the IDE or SCSI connector on the system board. See the label inside the server cover for the location of the IDE or SCSI controller connector.

6. Follow the instructions in “Installing the Files while Installing UnixWare” on page 87; then, return here and continue with step 7.
7. Power down the system.
8. Install any non-ServeRAID disk-storage adapters or controllers in the server; then, attach the drives to the disk-storage adapters and controllers.
9. Install the second ServeRAID adapter or controller from the list you created in step 3f on page 84; then, attach the drives to the ServeRAID adapter or controller.
10. Turn on the system and allow UnixWare to discover the new disk-storage adapters and controllers.
11. Power down the system.
12. Repeat steps 9, 10, and 11 until all ServeRAID adapters, ServeRAID controllers, and drives are installed.
13. You can now partition and format the logical drives attached to the additional ServeRAID adapters and controllers. See the information provided with UnixWare for more instructions.

Installing UnixWare on a Non-ServeRAID Drive: Use the instructions in this section if you are using multiple disk-storage adapters or controllers, you are installing UnixWare on a drive attached to a non-ServeRAID adapter or controller, and you intend to store only data on the drives attached to your ServeRAID adapters and controllers.

1. Install all ServeRAID adapters that you intend to use in your system.
2. Using the ServeRAID Configuration Program, create all of your arrays and define all of your logical drives.
3. Make a list of all of the ServeRAID adapters and controllers, including the order and slot number, installed in the system. To do this:
 - a. Turn on the server.

- b. When the ServeRAID Mini-Configuration prompt appears, press **Ctrl+i**. When a system contains more than one ServeRAID adapter or controller, a selection screen appears.
 - c. The menu lists the ServeRAID adapters and controllers in order. Select the first ServeRAID adapter or controller from the menu.
 - d. Select **Advanced Functions** from the Main Menu.
 - e. Select **View Controller and PCI Information** from the Advanced Functions menu.
 - f. Record the slot number for the ServeRAID adapter or controller; then, press **Esc** three times to return to the controller selection screen.
 - g. Repeat step 3c through step 3f until you record the slot number for each ServeRAID adapter or controller that appears on the selection screen.
4. Turn off the system; then, remove all ServeRAID, IDE, and SCSI disk-storage adapters and controllers except the one attached to the drive where you intend to install UnixWare.
- Note:** If one of the disk-storage or ServeRAID controllers that you need to remove is on the system board, do one of the following:
- If the CD-ROM drive that you are using to install your operating system is attached to the integrated controller, disconnect or remove all disk drives attached to the integrated controller.
 - If only disk drives are attached to the integrated controller, disconnect the SCSI or IDE cable for the integrated controller from the connector on the system board. See the label inside the server cover for the location of the SCSI and IDE cable connectors.
5. Follow the instructions in “Installing the Files while Installing UnixWare” on page 87; then, return here and continue with step 6.
 6. Power down the system.

7. Install any non-ServeRAID disk-storage adapters or controllers in the server; then, attach the drives to the disk-storage adapters and controllers.
8. Install the first ServeRAID adapter or controller from the list you created in step 3f on page 86; then, attach the drives to the ServeRAID adapter or controller.
9. Turn on the system and allow UnixWare to discover the new disk-storage adapters and controllers.
10. Power down the system.
11. Repeat steps 8, 9, and 10 until all ServeRAID adapters, ServeRAID controllers, and drives are installed.
12. You can now partition and format the logical drives attached to the ServeRAID adapters and controllers. See the information provided with UnixWare for more instructions.

Installing the Files while Installing UnixWare

To install the ServeRAID files while installing UnixWare 7.0:

1. Use the instructions provided with UnixWare to begin the installation.
2. When a message appears asking if you want to install any HBA diskettes, insert the *IBM ServeRAID Device Drivers for SCO Operating Systems Diskette*; then, select **Install HBA diskette**.
3. Use the instructions provided in the UnixWare manual to complete the normal installation process.

Installing the Files after Installing UnixWare

Use the following instructions to install the ServeRAID files after you install UnixWare, or use these instructions to update a previously installed ServeRAID file with a newer version. You can use the UnixWare Pkgadd or the UnixWare SCOAdmin utility program to install the files.

Installing an HBA Diskette File Using Pkgadd

1. Insert the *IBM ServeRAID Device Drivers for SCO Operating Systems Diskette* into the diskette drive.
2. Type:

```
pkgadd -d/ dev/dsk/f0t
```
3. Press **Enter**
4. When the message `Insert diskette into Floppy Drive 1` appears, press **Enter**.
5. When the message `Installation of IBM ServeRAID SCSI IHV HBA (ips) was successful` appears, type:

```
q
```
6. Press **Enter**; then after the device driver installs, restart the system.

Installing an HBA Diskette File Using SCOAdmin

1. Insert the *IBM ServeRAID Device Drivers for SCO Operating Systems Diskette* into the diskette drive.
2. Start the SCOAdmin utility program.
3. Select **Software_Management**.
4. Select **Application Installer**.
5. Select **Disk_A** from the Install From tab.
6. Click on the **Update View** button.
7. When the icon labeled **ips** appears in the window, click on **Install**.
8. After the device driver installs, restart the system.

Starting the Background-Server Components

To start the background-server components:

- If you are using OS/2 or Windows, double-click on the IPSRAID ADMIN-MONITOR icon on the desktop.
- If you are using OpenServer or UnixWare:

1. Make sure you are logged on as root.
 - a. If you are not, type:
su
 - b. When prompted, enter the root password.
2. Start the background-server component (daemon) running in the background. To do this, type:

```
ipsadm &
```

3. Press **Enter**.

- If you are using Novell NetWare:

1. Load the remote component. To do this, type:

```
load ipsadm.nlm
```

2. Press **Enter**

Notes:

- a. To load the NetWare Administration program with NetWare SFT III installed, load IPSADM.NLM in the mirrored server engine. The ServeRAID adapters and controllers in the primary and backup servers will appear to the Administration and Monitoring Program as if they were in one server.
- b. When a rebuild, synchronization, or logical-drive migration is in process, you cannot stop the IPSADM.NLM module by pressing the Esc key. To stop the module during one of these operations, you must unload the IPSADM.NLM module.

Using the Background-Server Components

This section provides information about background-server component command-line parameters and logging messages.

Using the Command-Line Parameters

To use the command-line parameters provided in the background-server components, issue the IPSADM command in the following format:

IPSADM *parameter1 parameter2* and so on...

Valid command-line parameters for the background-server components are as follows:

- ?** The **-?** command displays the help for the valid parameters.
- p:number** The **-p:*number*** command specifies the port number that the server will check for client connections.

The port number is a parameter used in TCP/IP to distinguish among different services on a single server. The default for the server utility programs is port number 1087. You can use this parameter to change the port number if another service on the system is using 1087.
- s:filename** The **-s:*filename*** command specifies the name of the file that contains security information. For more about security information, see "Background-Server Component Security" on page 91.
- f** The **-f** command specifies to log messages to the default file, IPSADM.LOG.
- f:filename** The **-f:*filename*** command lets you specify the name of a file in which to log messages.
- d** The **-d** command disables the logging of messages to the standard output, which is usually the screen.

Logging Messages

Messages generated by the ServeRAID adapter or controller consist of startup information, connecting and disconnecting clients, and error messages.

When using the `-f`, `-f:filename` and `-d` parameters, you can specify how you want the ServeRAID messages handled. The default is to log messages to the standard output, which is usually the screen. However, you can have these messages logged to other output devices, such as a printer or a text file.

The following information provides examples of different formats for using the IPSADM command and the results.

Command	Results
IPSADM	Logs messages to the standard output and not to a file.
IPSADM -f	Logs messages to the standard output and to the IPSADM.LOG file.
IPSADM -f:NEWFILE.LOG	Logs messages to the standard output and to the file that you defined: NEWFILE.LOG.
IPSADM -d	Disables the logging of messages.
IPSADM -f -d	Logs messages to the IPSADM.LOG file; however, messages are not logged to the standard output.

Background-Server Component Security

Security information is maintained in an optional text file on the server. The file stores unencrypted user names and unencrypted passwords; therefore, the file must be kept in a secure directory.

When user names and passwords are entered into the Administration and Monitoring Program (the client), they are encrypted for delivery to the server. The server decrypts the user names and passwords to verify proper access to the ServeRAID adapter or controller. If the verification is successful, the adapter or controller accepts

commands from the client. If no security file is present in the default directory, or the directory specified by the -s parameter, security is disabled. The server component then accepts commands from any client connection.

The security file contains one user name and password combination per line. The strings are separated by a colon (:) and each string has a maximum of eight characters.

Background-Server Component Name Resolution

The server component relies on name resolution to determine the host name from the client that is trying to connect. When a client is trying to access a remote server, the server tries to look up the name of the client connecting. The method used to look up the name is determined by the configuration of the server. Some possible methods for this are Domain Name Servers (DNS) or HOSTS files. With certain configurations, some timing delays might occur due to misconfiguration or inability to access the DNS. If problems persist, check your network configuration.

IPSSEND and IPSMON Programs

IPSSEND and IPSMON are advanced command-line programs that you can use to manage your ServeRAID adapters and controllers. These utility programs are provided on the *IBM ServeRAID Command Line Programs Diskette*. This ServeRAID diskette is available from the following address on the World Wide Web:

<http://www.pc.ibm.com/support>

See page 59 for the instructions needed to access the IBM support page.

You can use the IPSSEND program to view the configuration of a ServeRAID adapter or controller, rebuild a defunct drive, initialize logical drives, synchronize logical drives, and perform other functions.

You can use the IPSMON program to monitor a ServeRAID adapter or controller for defunct drives, predictive failure analysis (PFA) warnings, rebuild operations, synchronizations, and logical-drive migrations. This program can log a message to the monitor, to a file, or to both the monitor and a file whenever activities occur.

You can use the IPSEND and IPSMON programs with the following operating systems:

- IBM OS/2 Warp Server and OS/2 LAN Server
- Novell NetWare 3.12 and 4.1X
- Microsoft Windows NT
- SCO OpenServer 5.0.X
- SCO UnixWare 7.0

You also can use the IPSEND program with DOS, but DOS requires the ASPI Manager.

Installing IPSEND and IPSMON for OS/2, Windows NT, or NetWare

To install these programs for OS/2, Windows NT, or NetWare:

1. Start the server.
2. After the operating system loads, insert the *IBM ServeRAID Command Line Programs Diskette* into the diskette drive.
3. If you are using NetWare, go to step 5 on page 94. If you are using Windows NT or OS/2, create an IPSADM directory on your hard disk drive. To do this, go to the operating system command prompt and type:

```
md c:\ipsadm
```

Notes:

- a. The *c* represents the drive where OS/2 or Windows NT is installed.
 - b. If you installed the Administration and Monitoring Program files, you already created this directory.
4. Press **Enter**.

5. Copy the IPSSSEND.EXE file to your hard disk drive by typing one of the following at the command prompt:

- For OS/2, type:

```
copy a:\os2\ipssend.exe c:\ipsadm
```

- For Windows NT, type:

```
copy a:\nt\ipssend.exe c:\ipsadm
```

- For NetWare, type:

```
copy a:\netware\ipssend.nlm c:\nwserver
```

Notes:

- a. The *a* represents the drive assignment for the diskette drive that contains the ServeRAID diskette.
- b. The *c* represents the drive where OS/2, Windows NT, or NetWare is installed.
- c. These instructions assume that you installed NetWare in the NWSERVER directory.

6. Press **Enter**; then, copy the IPSMON.EXE file to your hard disk drive by typing one of the following at the command prompt:

- For OS/2, type:

```
copy a:\os2\ipsmon.exe c:\ipsadm
```

- For Windows NT, type:

```
copy a:\nt\ipsmon.exe c:\ipsadm
```

- For NetWare, type:

```
copy a:\netware\ipsmon.nlm c:\nwserver
```

Notes:

- a. The *a* represents the drive assignment for the diskette drive that contains the ServeRAID diskette.
- b. The *c* represents the drive where OS/2, Windows NT, or NetWare is installed.
- c. These instructions assume that you installed NetWare in the NWSERVER directory.

7. Press **Enter**; then, refer to Chapter 5, “Starting and Using the Utility Programs” on page 97 for information to start and use the IPSEND and IPSMON programs.

Installing IPSEND and IPSMON for OpenServer

To install these programs for OpenServer 5.0.X:

1. Insert the *IBM ServeRAID Command Line Programs Diskette* into the diskette drive.
2. Copy the program files from the *IBM ServeRAID Command Line Programs Diskette* by typing the following:

```
doscp -r a:/openserv/ipssend /usr/bin/ipssend
```

3. Press **Enter**; then, type:

```
doscp -r a:/openserv/ipsmon /usr/bin/ipsmon
```

4. Press **Enter**; then, change the access permissions by typing the following:

```
chmod 700 /usr/bin/ipssend
```

5. Press **Enter**; then, type:

```
chmod 700 /usr/bin/ipsmon
```

6. Press **Enter**; then, refer to Chapter 5, “Starting and Using the Utility Programs” on page 97 for information to start and use the IPSEND and IPSMON programs.

Installing IPSEND and IPSMON for UnixWare

To install these programs for UnixWare 7.0:

1. Insert the *IBM ServeRAID Command Line Programs Diskette* into the diskette drive.
2. Copy the program files from the *IBM ServeRAID Command Line Programs Diskette* by typing the following:

```
doscp -r a:/unixware/ipssend /usr/bin/ipssend
```

3. Press **Enter**; then, type:

```
doscp -r a:/unixware/ipsmon /usr/bin/ipsmon
```

4. Press **Enter**; then, change the access permissions by typing the following:

```
chmod 700 /usr/bin/ipssend
```
5. Press **Enter**; then, type:

```
chmod 700 /usr/bin/ipsmon
```
6. Press **Enter**; then, refer to Chapter 5, “Starting and Using the Utility Programs” on page 97 for information to start and use the IPSSEND and IPSMON programs.

Installing IPSSEND for DOS

To install IPSSEND for DOS:

1. Create a startable diskette. To do this, insert a blank diskette in diskette drive A; then, type:

```
format a: /s
```
2. Press **Enter**.
3. Copy the IPSSEND.EXE file from the DOS directory on the *IBM ServeRAID Command Line Programs Diskette* to the startable diskette.
4. Install the ASPI device driver on the startable diskette. To do this, insert the *IBM ServeRAID Device Driver Diskette* in diskette drive A; then, type:

```
a:\dos\uiinstall
```
5. Press **Enter**. Specify a:\ as the **Source Drive** and a:\ as the **Target Path**; then, follow the instructions that appear on the screen.
6. Leaving the startable diskette in the diskette drive, restart the system; then, refer to Chapter 5, “Starting and Using the Utility Programs” on page 97 for information to start and use the IPSSEND program.

Chapter 5. Starting and Using the Utility Programs

This chapter provides the information needed to start and use the ServeRAID Administration and Monitoring Program, IPSSSEND program, and IPSMON program.

This chapter contains:

Starting the Administration and Monitoring Program	98
Using the Administration and Monitoring Program	100
Using the Options Pull-Down Menu	100
Network Settings	100
General Options	102
Alert Options	103
Using the Administration Functions	105
Array Administration	105
Logical Drive Administration	108
Logical Drive Migration Administration	112
Physical Device Administration	116
Adapter Administration	118
Using the Monitoring Functions	121
Monitoring the Adapter Status Information	121
Monitoring the Device Event Logs	123
Monitoring the Logical Drive Information	124
Monitoring the Physical Device Information	125
Starting the IPSSSEND Program	126
Using the IPSSSEND Program	127
Server Roll-Out Commands	127
Error-Recovery Commands	130
Problem-Isolation and Debug Commands	133
RAID Configuration Commands	137
Starting the IPSMON Program	138
Using the IPSMON Program	139

Starting the Administration and Monitoring Program

Before you start the ServeRAID WIN32-Based Administration and Monitoring Program, review the following illustration to become familiar with the layout of its Main screen.

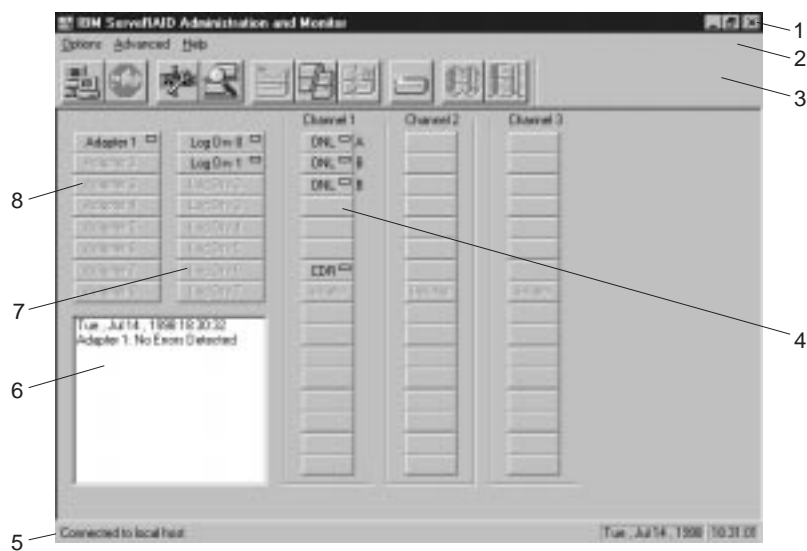

Figure 7. Administration and Monitoring Screen Layout

Descriptions of the numbered areas are as follows:

- 1. Title Bar** Displays the title of the application, along with the minimize icon, the maximize icon, and the close icon.
- 2. Menu Bar** Displays the pull-down menus for all supported functions.
- 3. Tool Bar** Displays the icons for the commonly used functions.
- 4. Device Area** Displays the state of each device connected to the physical channels of the ServeRAID adapter or controller, and if applicable, its array identifier.

- | | |
|------------------------------|---|
| 5. Status Bar | Displays help for the area where the cursor is currently pointing. Also displays the date and time. |
| 6. Status Window | Displays messages regarding the operational status of each adapter or controller. |
| 7. Logical Drive Area | Displays the number of logical drives created and the status of the logical drive. |
| 8. Adapter Area | Displays the number and status of the installed ServeRAID adapters and controllers |

To start the WIN32-Based Administration and Monitoring Program:

1. Do one of the following:
 - Double-click on the IBM ServeRAID Administration icon
or
 - Select **IBM ServeRAID Administration** from the Start menu.
2. The Administration and Monitoring Program starts in stand-alone mode. After this program loads, you can access the ServeRAID adapters and controllers.

When the Main window appears:

- If you are running the program in the stand-alone mode and you have ServeRAID adapters or controllers installed in your system, the current settings of the installed adapters or controllers will appear on the screen.
 - If you are running the program from a client with no ServeRAID adapters or controllers, a message will appear stating that no ServeRAID adapters or controllers are installed in your system.
3. To access the server that contains the ServeRAID adapters or controllers, select **Network Settings** from the Options menu.
 4. When the window appears prompting for Stand-alone or Client/Server, click on the **Client/Server** button.

5. In the edit box, type in the host name of the server that you want to access.

or

Select the host name from the pull-down list; then, click on **Connect**.

Note: If security is enabled on the server, you must enter a valid user name and password.

Using the Administration and Monitoring Program

You can use the Administration and Monitoring Program to monitor your ServeRAID adapters and controllers, view the ServeRAID configuration and associated devices, rebuild an array, create a logical drive, create an array, delete an array, dynamically increase the logical-drive size, change RAID levels, and much more.

Using the Options Pull-Down Menu

The following choices are available from the Options pull-down menu on the Main Screen of the Administration and Monitoring Program:

- Network Settings
- General Options
- Alert Options

Network Settings

If you want to monitor the ServeRAID adapters and controllers across a network, you must switch to client/server mode.



You can use the Network Settings dialog box to select and connect to servers in your network that contain IBM ServeRAID adapters or controllers.

To select and connect to a server:

1. Click on the  icon on the Tool Bar or select **Network Settings** from the **Options** pull-down menu. A screen similar to the following appears.

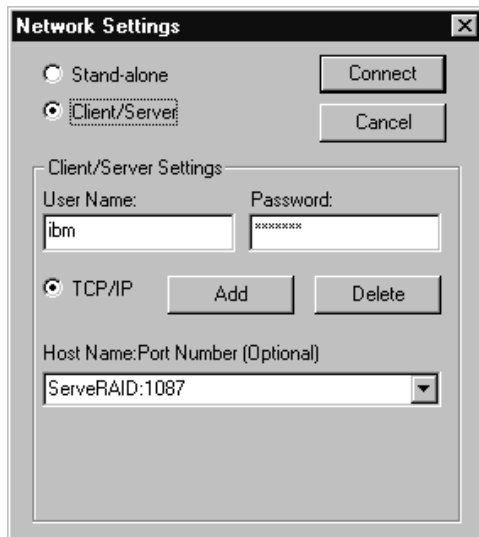

2. Click on the **Client/Server** radio button.
3. If security is enabled on the server to which you are connecting, type in your **User Name** and **Password** as defined by the security file on the server to which you are connecting. (Refer to “Background-Server Component Security” on page 91 for information on the security file).
4. Type in either the **Host Name** or the TCP/IP **Address** of the system, or select it from the pull-down list.

Note: If your server was started on any port other than the default (1087), after the Host Name or TCP/IP Address that you just entered, type in a colon and the correct port number for your configuration (for example: ServeRAID:1088).

5. Click on **Connect** to initiate a connection with the remote system.

General Options

When you select General Options from the Options pull-down menu, a screen similar to the following appears.

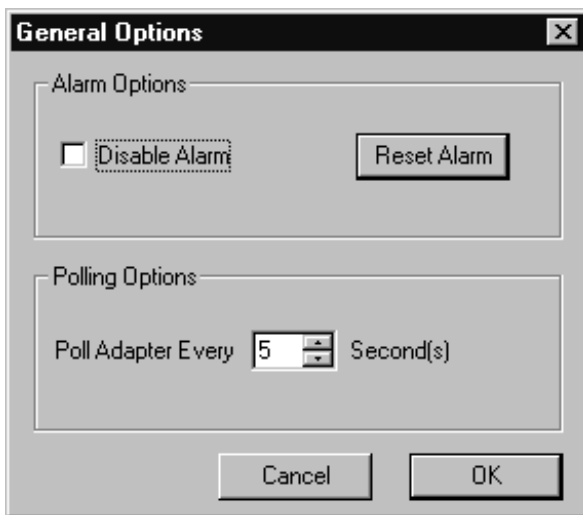

You can use this screen to:

- Enable or Disable the alarm
- Reset the alarm
- Set the polling options

Enabling or Disabling the Alarm: The alarm alerts you to a failure in the system. It sounds if any of the following conditions occur:

- A DDD hard disk drive is found.
- A Predictive Failure Analysis (PFA) error occurs.
- A ServeRAID adapter or controller is not responding.

To enable or disable the alarm, click on the box for **Disable Alarm** on the **General Options** screen. Placing a check in the check box disables the alarm; removing the check enables the alarm.

Resetting the Alarm:



Resetting the alarm turns off the alarm for the current failure without disabling the feature.

To reset the alarm, you can either click on the  icon or click on **Reset Alarm** on the General Options screen.

Polling Options: The ServeRAID adapter or controller will *poll*, or check, your server at a specified time interval for any changes that may have occurred in the server.

You can choose how often the adapter or controller polls the server by specifying a time interval on the options menu, from five to 60 seconds. The default time interval setting is five seconds.

The program will poll for the following events:

- Rebuild started
- Rebuild completed
- Synchronization started
- Synchronization completed
- Migration started
- Migration completed
- PFA error detected
- Dead drive detected
- Adapter or controller is not responding to commands

Alert Options

The Netfinity Manage alerts allow system administrators who are using the IBM Netfinity Manager Program to configure the ServeRAID Administration and Monitoring Program to notify the Netfinity Alert Manager of various activities occurring on the server.

To configure the settings for the Netfinity Manager alerts:

1. Open the Options pull-down menu.
2. Click on **Alert Options**.

3. Click on **Netfinity Alerts**. A screen similar to the following appears.



Note: The default setting for the Netfinity Manager alerts is disabled.

4. To enable all Netfinity Manager alerts, click on the check box next to Enable Netfinity Alerts.
5. To disable any of the Netfinity Manager alerts:
 - a. Ensure there is a check in the check box next to Enable Netfinity Alerts.
 - b. Click on the check box next to the specific alert or alerts you want disabled.
6. To test the Netfinity Manager integration, click on the **Send Test Alert** button. This will send a Netfinity Manager alert to the Alert Manager with a test message.

When you enable Netfinity Manager Alerts, the ServeRAID adapter or controller will relay the following three types of messages to the Netfinity Alert Manager:

- a. Information
 - Rebuild started
 - Rebuild completed
 - Synchronization started

- Synchronization completed
 - Migration started
 - Migration completed
- b. Warning
- PFA error detected
- c. Critical
- Dead drive detected
 - Adapter or controller is not responding to commands

By knowing what these types of messages are, you can configure the Netfinity Manager program with instructions for monitoring the server configuration and the appropriate action to take if an alert is given. For example, you could set the Netfinity Manager program to dial a specified phone number, should a defunct drive be detected on any server across the network. See the documentation provided with Netfinity Manager for more information.

Using the Administration Functions

This section provides information about using the following ServeRAID administration functions:

- Array administration
- Logical drive administration
- Logical drive migration administration
- Physical drive administration
- Adapter administration

Array Administration

This section provides information about creating and deleting disk arrays.

Creating Disk Arrays:



You can use disk arrays to improve security, performance, and reliability.

To create a disk array:

1. Click on the  icon on the Tool Bar or select **Manage Disk Arrays** from the Advanced pull-down menu; then, select **Create Disk Array**. A screen similar to the following appears.



2. Select one or more Ready (RDY) drives for the new disk array from the Main screen of the Administration and Monitoring Program.

To select a RDY drive, click the desired RDY button from the device area. A disk array identifier appears beside each RDY drive added to the disk array.

If you change your mind about a selected drive, select the button again to remove the selected drive from the disk array.

3. Click on **OK** to define a logical drive for the new array. A screen similar to the following appears.



4. Select the appropriate RAID level from the pull-down list.

Note: The number of hard disk drives in the array determines the RAID levels available for the array.

- If the array contains one hard disk drive, you can select only RAID level-0 for the logical drive.

- If the array contains two hard disk drives, you can select RAID level-0 or RAID level-1 for the logical drive.
- If the array contains three or more hard disk drives, you can select RAID level-0, RAID level-1, or RAID level-5 for the logical drive.

5. Enter the **Requested Space** in the entry field.

The ServeRAID program uses the maximum available space for the selected RAID level to calculate the default value that it assigns.

Note: The actual logical drive size might be slightly different from what you type in the **Requested Space** field. The RAID level and the number of hard disk drives determine the size of the logical drive. For example, a disk array consisting of three, 1 GB hard disk drives with a requested RAID level-0 logical drive of 1000 MB will actually contain only 999 MB because the data is striped across all three drives, with 333 MB on each drive.

6. Click on **OK** to create the disk array.

Deleting Disk Arrays:



Deleting a disk array deletes all logical drives that are defined in that disk array. All data and programs on the logical drives in the disk array will be lost during this procedure.

To delete a disk array:

1. Click on the  on the Tool Bar or select **Manage Disk Arrays** from the Advanced pull-down menu; then, select **Delete Disk Array**. A screen similar to the following appears.

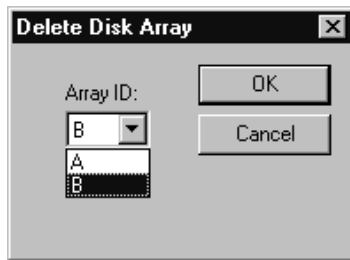

2. Select the desired disk array ID from the pull-down list.

Attention:

Before proceeding, ensure that you have backed up any data and programs that you want to save.

3. Click on **OK** to delete the disk array.

Note: For some operating systems, deleting a disk array and its associated logical drives might change the drive-letter assignments of the remaining drives when you restart the system.

Logical Drive Administration

This section provides the information needed to create logical drives, initialize and synchronizing logical drives, or access blocked logical drives.

Creating Logical Drives:

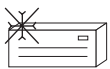

Each ServeRAID adapter or controller supports a maximum of 8 logical drives. Depending upon the stripe-unit size being used, you can combine a maximum of 8 or 16 physical drives into each logical drive.

To create a logical drive:

1. Click on the  icon on the Tool Bar or select **Manage Logical Drive** from the Advanced pull-down menu; then, select **Create Logical Drive**. A screen similar to the following appears.



2. Select the desired disk array ID from the pull-down list.
3. Select the appropriate RAID level from the pull-down list.

Note: The number of hard disk drives in the array determines the RAID levels available for the array.

- If the array contains one hard disk drive, you can select only RAID level-0 for the logical drive.
- If the array contains two hard disk drives, you can select RAID level-0 or RAID level-1 for the logical drive.
- If the array contains three or more hard disk drives, you can select RAID level-0, RAID level-1, or RAID level-5 for the logical drive.

4. Enter the **Requested Space** in the entry field.

The ServeRAID program uses the maximum available space for the selected RAID level to calculate the default value that it assigns.

Note: The actual logical drive size may be slightly different from what you type in the **Requested Space** field. The RAID level and the number of hard disk drives determine the size of the logical drive. For example, a disk array consisting of three, 1 GB hard disk drives with a requested RAID level-0 logical drive of 1000 MB will actually contain only 999 MB because the data is striped across all three drives, with 333 MB on each drive.

5. Click on **OK** to create the logical drive.

Notes:

1. If you plan to use the Logical Drive Migration (LDM) feature, *do not* define more than seven logical drives. The LDM feature requires one free logical drive to perform the migration. Refer to “Logical Drive Migration Administration” on page 112 for more information.
2. If you plan to use the Change RAID Level function of the LDM feature, you must assign the same RAID level to all logical drives within a single disk array. Refer to “Change RAID Levels” on page 112 for more information.

Initializing Logical Drives: Initializing a logical drive erases the first 1024 sectors on the drive and prevents access to any data previously stored on the drive.

To initialize a logical drive:

1. Select the desired logical drive from the Main screen of the Administration and Monitoring Program.
2. Click on **Initialize** to initialize the drive.
3. If you have initialized a RAID level-5 drive, you must synchronize to ensure data integrity. Go to “Synchronizing Logical Drives.”

Synchronizing Logical Drives: The purpose of synchronizing logical drives is to compute and write the parity data on the selected drives.

If the type of ServeRAID adapter or controller you are using does not support the auto-synchronization and data-scrubbing features, manually synchronize your RAID level-1 and RAID level-5 logical drives weekly. This does not alter data on the drive.

Synchronizing a logical drive verifies that the data redundancy for the logical drive is correct.

To synchronize a logical drive:

1. Select the desired logical drive from the Main screen of the Administration and Monitoring Program.

2. Click on **Synchronize** to synchronize the drive.
3. The synchronization begins automatically and reports progress information on the screen.

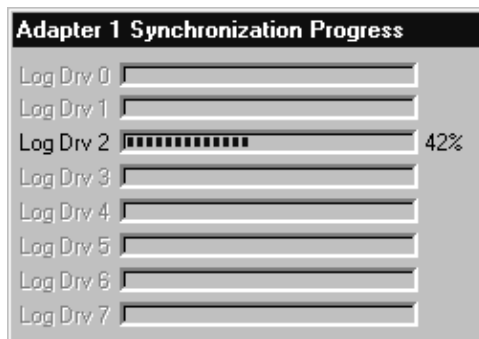

Note: Only one synchronization command can be active at a time.

Unblocking Logical Drives: When the ServeRAID adapter or controller performs a Rebuild operation on an array, it reconstructs the data that was stored in RAID level-1 and RAID level-5 logical drives. However, the ServeRAID adapter or controller cannot reconstruct the data that was stored in any RAID level-0 logical drives in that array. The data in the RAID level-0 logical drives is blocked when the ServeRAID adapter or controller detects that the array is valid, but the data might be damaged.

After the Rebuild operation completes, you can unblock the RAID level-0 logical drives and access them once again. But remember, the logical drive might contain damaged data. You must either re-create, install, or restore the data from the most recent backup disk or tape.

To unblock a blocked drive:

1. Select the blocked logical drive from the Main screen of the Administration and Monitoring Program.
2. Click on **Unblock** to unblock the drive.
3. Initialize all unblocked logical drives before using them. See "Initializing Logical Drives" on page 110.

4. Restore the data to the drive from your most recent backup disk or tape.

Logical Drive Migration Administration

The logical drive migration (LDM) feature dynamically changes the current logical drive structure. You can use this procedure to change the RAID level, increase the free space in a disk array, or change the size of a logical drive.

To use the LDM feature, you must have at least two logical drives available: one free (FRE) logical drive and one source logical drive that is in the okay (OKY) state. During the LDM procedure, the ServeRAID adapter or controller changes the state of the FRE logical drive to SYS; then, temporarily uses the SYS drive to perform the migration. When the migration procedure completes, the ServeRAID adapter or controller changes the state of the SYS drive back to FRE.

Change RAID Levels:



You can change (migrate) the RAID levels of currently defined logical drives. To use the Change RAID Level feature, all of the logical drives within the array must be the same RAID level.

The ServeRAID adapters and controllers support changing RAID levels as follows:

- Change two-drive RAID level-0 to RAID level-5 by adding one hard disk drive
- Change two-drive RAID level-1 to RAID level-5 by adding one hard disk drive
- Change from RAID level-5 to RAID level-0 by removing one hard disk drive

To change the RAID level of an existing disk array:

Note: If you are migrating to RAID level-0, the last drive defined in the array becomes RDY.

1. Click on the  icon on the Tool Bar or select **Manage Disk Arrays** from the Advanced pull-down menu; then, select **Logical Drive Migration**. A screen similar to the following appears.

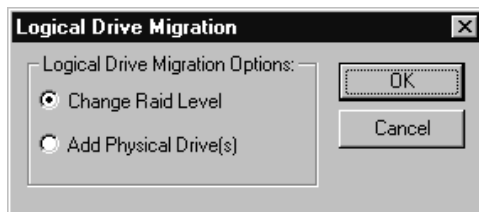

2. Select **Change RAID Level**.
3. Click on **OK**.

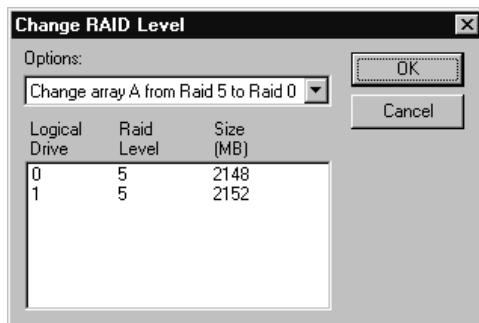

4. Select a migrating option from the pull-down list.
Note: The affected logical drives appear, based on the migrating option you select.
5. Click on **OK** to proceed.
6. Click on **OK** to verify the operation.
7. Select a Ready (RDY) drive to add to the array, if you are migrating to RAID level-5.

Adding a Physical Drive:



You can expand currently defined arrays by adding one to three new hard disk drives.

The ServeRAID adapters and controllers support adding new space to a disk array in the following scenarios:

- You can increase the free space in a disk array without changing the size of the logical drives. This is useful when you need to add logical drives to your existing disk arrays. Refer to the following illustration.

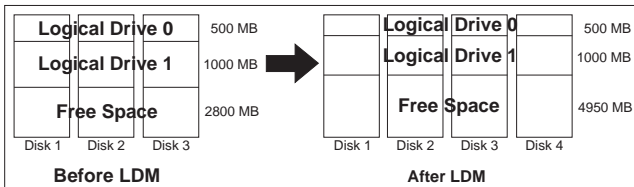

For example, an existing disk array uses three, 2150 MB hard disk drives that are configured as two RAID level-5 logical drives (one 500 MB and 1000 MB) and 2800 MB of free space. If you use the logical drive migration procedure and add a 2150 MB hard disk drive to increase the amount of free space, the end result will be two RAID level-5 logical drives (one 500 MB and one 1000 MB) and with 4950 MB of free space.

- You can increase the size of all the logical drives proportionally in a disk array. This is useful when you want to increase the size of the currently defined logical drives. Refer to the following illustration.

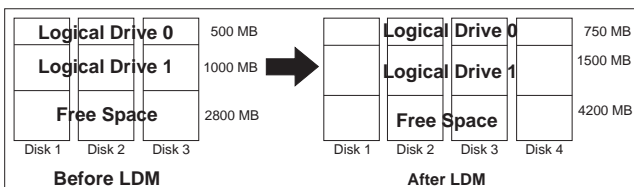

For example, an array uses three 2150 MB hard disk drives that are configured as two RAID level-5 logical drives (one 500 MB

and 1000 MB) and 2800 MB of free space. If you use the logical drive migration procedure and add a 2150 MB hard disk drive to proportionally increase the size of the disk array, the end result will be two RAID level-5 logical drives (one 750 MB and 1500 MB) and 4200 MB of free space.

To add a physical device:

1. Click on the  icon on the Tool Bar or select **Manage Disk Arrays** from the Advanced pull-down menu; then, select **Logical Drive Migration**. A screen similar to the following appears.

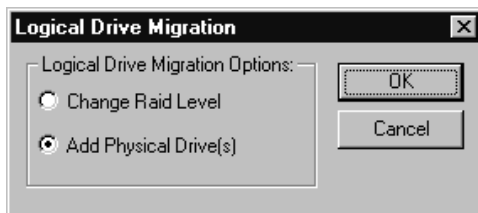

2. Select **Add Physical Drive(s)**.

A prompt appears requesting that you select from 1 to 3 Ready (RDY) drives to add to the existing array.

3. Click on the appropriate RDY drives on the Main screen. An **X** appears beside the selected drives.
4. When you are finished selecting drives, click on **OK**.

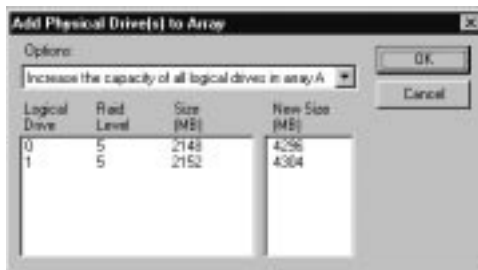

5. Select one of the available expansion options from the pull-down list.

The screen will show a list of the affected logical drives with their new sizes.

6. Click on **OK**.

Physical Device Administration

This section provides the information needed to set device states and rebuild devices.

Setting Physical Device States: The following table shows the valid device states and valid alternative states.

Device State	Alternative States
EMP	RDY SBY
SBY	RDY EMP HSP SHS
DHS	EMP HSP SHS
SHS	HSP DHS
DDD	ONL RBL
RDY	EMP HSP SHS SBY
HSP	RDY SHS DHS
ONL	DDD
RBL	DDD ONL

To set or change the physical device state:

1. Select the device from the Main screen of the Administration and Monitoring Program.
2. Click on the radio button that indicates the desired state.

Note: If you set a DDD drive to ONL without performing a Rebuild (RBL) operation and that drive is part of a critical (CRT) logical drive, your system might lose data.

3. Click on **Set Device State**.

Rebuilding a Device: When a hard disk drive goes defunct (DDD), a Rebuild operation is required to reconstruct the data for the device in its respective disk array. The ServeRAID adapters and controllers can reconstruct RAID level-1 and RAID level-5 logical drives, but they cannot reconstruct data stored in RAID level-0 logical drives. To prevent data integrity problems, the ServeRAID adapters and controllers set the RAID level-0 logical drives to *Blocked* during a Rebuild operation. After the Rebuild operation completes, you can unblock the RAID level-0 logical drives, and access them once again. But remember, the logical drive might contain damaged data. (Refer to “Unblocking Logical Drives” on page 111 for more information.)

To perform a Rebuild operation:

1. Click on the DDD device on the Main screen of the Administration and Monitoring Program.
2. Click on **Rebuild Device**.
3. Select a RDY drive to use to reconstruct the data, or click on **OK** to use the same drive slot and SCSI ID if you have physically replaced the defunct drive.
4. The reconstruction begins automatically and reports progress information on the screen.

Notes:

1. The ServeRAID adapter or controller can perform only one Rebuild operation at a time.
2. If the array contains a critical (CRT) logical drive, the Rebuild operation changes the hard disk drive state from DDD to RBL. After the Rebuild operation completes, the hard disk drive state changes from RBL to ONL. (If you rebuild to a RDY drive, the DDD drive is removed from the disk array and becomes a defunct hot-spare (DHS).)
3. The hard disk drive being rebuilt must be the same size or larger than the failed drive.
4. If a hot-spare (HSP) drive is available, a Rebuild operation will start automatically.
5. If multiple hot-spare (HSP) drives are available, the ServeRAID adapter or controller searches all the drives on each channel for a hot-spare drive of the appropriate size. The first appropriate hot-spare drive found enters the Rebuild (RBL) state.

Adapter Administration

This section provides instructions for copying the drive configuration to the ServeRAID adapter or controller, copying the ServeRAID adapter or controller configuration to the drives, initializing the adapter or controller configuration, and scanning for new drives.

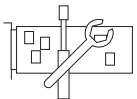
Copying the Drive Configuration to the Adapter:

You can copy the configuration stored on the hard disk drives to the ServeRAID adapter or controller.

This operation is useful when drives are imported from other systems.

To copy the configuration:

1. Click on the  icon on the Tool Bar or select **Adapter Configuration** from the Advanced pull-down menu. A screen similar to the following appears.

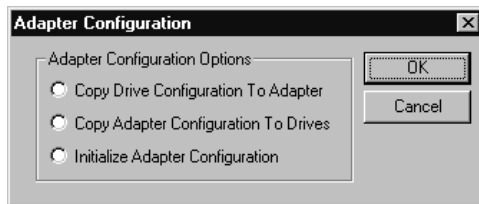

2. Select **Copy Drive Configuration to Adapter**.
3. Click on **OK**.

Copying the Adapter Configuration to the Drives:

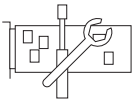

You can copy the configuration stored for the ServeRAID adapter or controller to all configured hard disk drives.

To copy the configuration:

1. Click on the  icon on the Tool Bar or select **Adapter Configuration** from the Advanced pull-down menu. A screen similar to the following appears.

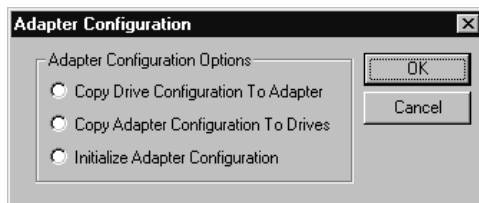

2. Select **Copy Adapter Configuration to Drives**.
3. Click on **OK**.

Initializing the Adapter:

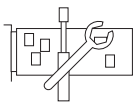

Initializing the adapter or controller configuration clears all the logical drives and resets all the functional hard disk drives to the Ready (RDY) state.

This operation is useful when you want to start over and create a new configuration.

To initialize the adapter or controller:

1. Click on the  icon on the Tool Bar or select **Adapter Configuration** from the Advanced pull-down menu. A screen similar to the following appears.

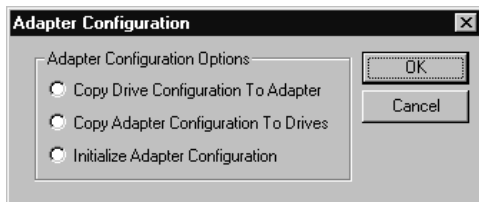

2. Select **Initialize Adapter Configuration**.

Attention:

After you initialize the configuration, you will not have access to any data stored on the logical drives attached to the selected ServeRAID adapter or controller.

This choice deletes the existing configuration information, sets all functional hard disk drives attached to the controller to the Ready state, and deletes all logical drives defined for the controller.

This choice *does not* change any of the ServeRAID adapter or controller settings (such as the stripe-unit size, rebuild rate, and so on) from their current or customized values.

3. Click on **OK**.

Scanning for New Drives: You can scan for new devices attached to the ServeRAID adapter or controller.

To scan for new drives, click on the  icon on the Tool Bar or select **Scan For New Drives** from the Advanced pull-down menu.

Using the Monitoring Functions

This section contains instructions for using the Administration and Monitoring Program to monitor the ServeRAID adapter and controller status information, event logs, logical drive information, and physical device information.

Monitoring the Adapter Status Information

A green or red light on the screen indicates the currently active adapter button. (Green indicates that the ServeRAID adapter or controller is responding and red indicates that it is not responding.) If there is more than one ServeRAID adapter or controller in the system, click once on the appropriate adapter or controller to make it active.

You can then monitor the status by clicking on the active adapter button on the Main screen of the Administration and Monitoring Program.

Note: You might need to use the scroll bar and scroll down to see all of the items that appear on this screen.

Descriptions of the information that appears on the screen are as follows:

Adapter Number	The active adapter or controller (1 to 8).
Number of Logical Drives	The number of defined logical drives (0 to 8).
Unattended Mode	Off - The user chooses the recovery method when there is a ServeRAID startup error.

	On - The adapter or controller chooses the recovery method when there is a ServeRAID startup error.
Code Block Version	The current version number of the firmware loaded on the adapter or controller.
Boot Block Version	The current version number of the bootable microcode loaded on the adapter or controller.
Concurrent Commands	The maximum number of concurrent commands supported.
Maximum Devices Supported	The maximum number of devices supported.
Flash Program Count	The current number of times the flash EEPROM has been written.
Defunct Disk Count	The current number of defunct hard disk drives.
Rebuild Rate	The current setting (Low, Medium, or High) of the rebuild rate.
Hot-Swap Rebuild	The current state (Enabled or Disabled) of the hot-swap rebuild feature.
Offline Logical Drive Count	The current number of offline logical drives.
Configuration Update Count	The number of times that the ServeRAID configuration has been updated.
NVRAM Battery Backup Device	The current state of the battery-backup cache (installed, not installed, or defective).

Monitoring the Device Event Logs

The ServeRAID adapters and controllers store information concerning various events in the event logs. There are four types of event logs: a device event log, a hard event log, a soft event log, and a configuration event log. (See Chapter 3, "Using the Configuration Programs" on page 19 for information about the configuration event log.)

To view the hard, soft, or device event logs:

1. Click on the **adapter** on the Main screen of the Administration and Monitoring Program.
2. Select an event log button from the bottom of the screen.

The Device Event Log contains event counters for each attached physical device, as follows:

- Parity Event - The ServeRAID adapter or controller detected a parity event while transferring data on the SCSI bus. A large number of parity events might indicate a problem with the SCSI cable, connectors, or terminators on the SCSI channel.
- Soft Event - These events are detected by the SCSI device and reported to the ServeRAID adapter or controller through the SCSI Check Condition status.
- Predictive Failure Analysis (PFA) - The device has signaled the adapter or controller that it might fail in the near future.
- Hard Event - These events are detected by the ServeRAID adapter or controller. The most likely cause of a hard event is a problem with the SCSI cabling, termination, or adapter seating. If one of these is not the problem, have the system serviced.
- Misc Event - These miscellaneous events are detected by the ServeRAID adapter or controller. These events do not include parity, soft, PFA, or hard events. The most likely cause of a miscellaneous event is a cable, termination, or connector problem.

Note: Under normal operating conditions, the event logs will contain entries that are not errors.

Monitoring the Logical Drive Information

You can monitor the logical drive information by clicking on the desired logical drive button on the Main screen of the Administration and Monitoring Program.

Descriptions of the information that appears on the Logical Drive Information screen are as follows:

Logical Drive Number	The number of the logical drive.
Blocked	No - The logical drive is accessible. Yes - The logical drive is not accessible.
Part of Array	The identifier of the logical drive disk array (A, B, C, D, E, F, G, H).
Part of Merge Group	The identifier of the logical drive merge group (1 through 254).
Date Created	The date the logical drive was created.
State	The current state (see "Logical Drive State Descriptions" on page 37 for more information).
Size	The size in megabytes.
RAID Level	RAID level (0, 1, or 5).
Write Policy	WT - Write-through. WB - Write-back.
NVRAM Battery Backup	Enable - The battery-backup cache is On. Disable - The battery-backup cache is Off.
Read Ahead	Off - Disk Read-Ahead is inactive. On - Disk Read-Ahead is active.
Stripe-Unit Size	The size of each stripe unit per hard disk (8, 16, 32, 64).

Number of Chunks	The number of hard disk drives that make up the logical drive.
Stripe Order	The channel and SCSI ID of the physical drives that make up the logical drive.

Monitoring the Physical Device Information

You can monitor the physical device information by clicking on the desired device button on the Main screen of the Administration and Monitoring Program.

Descriptions of the fields that might appear on the Device Management screen are as follows.

Note: The number of fields that appear on the Device Management screen depend on the physical device selected.

Channel	The channel to which the device is connected (1, 2, or 3).
SCSI ID	The SCSI ID (0 to 15).
Vendor	The manufacturer of the physical device.
Serial Number	The manufacturer identifier.
Size	The size in megabytes.
State	The current state (see “Physical Drive State Descriptions” on page 38 and “Logical Drive State Descriptions” on page 37 more information).
Soft Event	The number of soft events reported from the device event log.
Hard Event	The number of hard events reported from the device event log.
Misc Event	The number of miscellaneous events reported from the device event log.
Parity Event	The number of parity events reported from the device event log.

PFA Event **Yes** - device indicates predictive failure analysis event.
No - device does not indicate predictive failure analysis error.

Starting the IPSSEND Program

You can run the IPSSEND program from the operating system command line.

To start the IPSSEND program:

- If you are using OS/2 or Windows NT:
 1. Type:
 `c:\ipsadm\ipssend`
 2. Press **Enter**.

 Note: The *c* represents the drive where OS/2 or Windows NT is installed.
- If you are using NetWare:
 1. From the console, type:
 `load ipssend`
 2. Press **Enter**.
- If you are using DOS:
 1. Insert the bootable IPSSEND diskette that you created into diskette drive A; then, type:
 `a:\ipssend`
 2. Press **Enter**.
- If you are using OpenServer or UnixWare:
 1. Type:
 `/usr/bin/ipssend`
 2. Press **Enter**.

Using the IPSEND Program

When you run the IPSEND program with no command-line parameters, a list of available functions and their specific parameters appears. All functions require a minimum set of parameters to run the command. If you run the IPSEND program with a specific function but without its required parameters, specific help for that function will appear on the monitor.

There are four basic types of IPSEND commands:

- Server roll-out commands
- Error-recovery commands
- Problem-isolation and debug commands
- RAID configuration commands

Server Roll-Out Commands

The IPSEND server roll-out commands include the following:

BACKUP Use the BACKUP command to save a ServeRAID adapter or controller configuration to a diskette or to a hard disk drive. The ServeRAID adapter or controller configuration must be valid.

Supported operating systems: Windows NT, OS/2, NetWare, DOS, OpenServer, and UnixWare.

Command:

IPSEND BACKUP *Controller Filename Oparm*

Replace:

- *Controller* with the ServeRAID controller number (1 to 8)
- *Filename* with the path and file name where the configuration is to be written
- *Oparm* with the optional parameter, NOPROMPT, to override the user prompt

COPYLD Use the COPYLD command to copy a source logical drive to a target logical drive. The size of the target logical drive must be greater than or equal to the size of the source logical drive.

Supported operating system: DOS

Command:

IPSEND COPYLD *Controller Source Target Oparm*

Replace:

- *Controller* with the ServeRAID controller number (1 to 8)
- *Source* with the source logical drive number
- *Target* with the target logical drive number
- *Oparm* with the optional parameter, NOPROMPT, to override the user prompt

RESTORE Use the RESTORE command to load a configuration from a file stored on a diskette or a hard disk drive. The configuration must be a valid configuration file from the BACKUP option on the *IBM ServeRAID DOS Configuration Utility Program Diskette* or IPSEND. This operation overwrites the existing configuration information stored for the ServeRAID adapter or controller.

Supported operating systems: Windows NT, OS/2, NetWare, OpenServer, UnixWare, and DOS

Command:

IPSEND RESTORE *Controller Filename Oparm*

Replace:

- *Controller* with the ServeRAID controller number (1 to 8)
- *Filename* with the path and file name where the configuration is to be written
- *Oparm* with the optional parameter, NOPROMPT, to override the user prompt

INIT

Use the INIT command to initialize the first 0.5 MB of a logical drive. This process will erase the partition tables on the drive, and all data on the logical drive will be lost.

Supported operating systems: Windows NT, OS/2, NetWare, OpenServer, UnixWare, and DOS

Command:

```
IPSEND INIT Controller DriveNum Oparm
```

Replace:

- *Controller* with the ServeRAID controller number (1 to 8)
- *DriveNum* with the logical drive number (0 to 7)
- *Oparm* with the optional parameter, NOPROMPT, to override the user prompt

INITSYNC

Use the INITSYNC command to initialize and synchronize a logical drive at the same time. This command works only on RAID level-1 and level-5 logical drives. The command will erase the entire logical drive, and all data on the logical drive will be lost.

Supported operating systems: Windows NT, OS/2, NetWare, OpenServer, UnixWare, and DOS

Command:

```
IPSEND INITSYNC Controller DriveNum Oparm
```

Replace:

- *Controller* with the ServeRAID controller number (1 to 8)
- *DriveNum* with the logical drive number (0 to 7)
- *Oparm* with the optional parameter, NOPROMPT, to override the user prompt

SYNCH Use the SYNCH command to synchronize the parity information on redundant logical drives. If the parity information is inconsistent, the IPSSSEND program will repair it automatically.

Supported operating systems: Windows NT, OS/2, NetWare, OpenServer, UnixWare, and DOS

Command:

IPSSSEND SYNCH *Controller Scope DriveNum*

Replace:

- *Controller* with the ServeRAID controller number (1 to 8)
- *Scope* with Drive for a single logical drive
- *DriveNum* with the logical drive number (0 to 7)

Error-Recovery Commands

The IPSSSEND error-recovery commands include the following:

GETSTATUS Use the GETSTATUS command to display the current logical-drive status for the most recent rebuild, synchronization, or logical-drive migration. The status includes such information as the remaining size of the logical drive, the percentage completed for the function in process, or information about the most recently completed logical-drive function.

Supported operating systems: Windows NT, OS/2, NetWare, OpenServer, UnixWare, and DOS

Command:

IPSSSEND GETSTATUS *Controller*

Replace:

Controller with the ServeRAID controller number (1 to 8)

REBUILD Use the REBUILD command to rebuild a designated disk drive. This command is valid for disk arrays that contain one or more logical drives that are in

the critical (CRT) state. Progress is indicated during the rebuild operation, but you can also use the GETSTATUS command to obtain progress information about the rebuild.

Supported operating systems: Windows NT, OS/2, NetWare, OpenServer, UnixWare, and DOS

Command:

```
IPSEND REBUILD Controller DCh DSID NCh NSID
```

Replace:

- *Controller* with the ServeRAID controller number (1 to 8)
- *DCh* with the channel number for the Defunct drive (1 to 3)
- *DSID* with the SCSI ID for the Defunct Drive (0 to 15)
- *NCh* with the channel number for the New Drive (1 to 3)
- *NSID* with the SCSI ID for the New Drive (0 to 15)

SETSTATE

Use the SETSTATE command to change the state of a physical device from its current state to a new state.

Attention:

You must be very careful when you use this command. For example, you might lose data if you reset a Defunct (DDD) device to Online (ONL) without first performing a Rebuild operation.

Supported operating systems: Windows NT, OS/2, NetWare, OpenServer, UnixWare, and DOS

Command:

IPSSEND SETSTATE *Controller Channel SID NState*

Replace:

- *Controller* with the ServeRAID controller number (1 to 8)
- *Channel* with the channel number for the drive (1 to 3)
- *SID* with the SCSI ID for the drive (0 to 15)
- *NState* with the new state for the drive. Valid states are: EMP for Empty, RDY for Ready, HSP for Hot Spare, SHS for Standby Hot Spare, DDD for Defunct Disk Drive, DHS for Defunct Hot Spare, RBL for Rebuild, SBY for Standby, and ONL for Online. (See "Setting Physical Device States" on page 116 for more information.)

UNBLOCK

Use the UNBLOCK command to gain access to a blocked logical drive. RAID level-0 logical drives become blocked if they are in an array that contains RAID level-1 or level-5 logical drives and the array is being rebuilt. Because the RAID level-0 logical drives cannot be rebuilt, the data stored on the RAID level-0 logical drives is damaged and should not be accessed. After you issue the UNBLOCK command, you must re-create or restore the data previously stored on the RAID level-0 logical drives.

Supported operating systems: Windows NT, OS/2, NetWare, OpenServer, UnixWare, and DOS

Command:

IPSSEND UNBLOCK *Controller DriveNum*

Replace:

- *Controller* with the ServeRAID controller number (1 to 8)
- *DriveNum* with the logical drive number (0 to 7)

Problem-Isolation and Debug Commands

The IPSSSEND problem-isolation and debug commands include the following:

CERTIFY Use the CERTIFY command to verify the media of a hard disk drive. If the program finds a media error, it reassigns the sectors. A summary of reassignments and PFA errors appears upon completion of the verification.

Supported operating system: DOS

Command:

IPSSSEND CERTIFY *Controller Channel SID*

Replace:

- *Controller* with the ServeRAID controller number (1 to 8)
- *Channel* with the channel number for the device (1, 2, or 3)
- *SID* with the SCSI ID for the device (0 to 15)

ERASEEVENT Use the ERASEEVENT command to clear all logged entries in the designated event log. See GETEVENT help for information about the contents of the Device Event Log and the Adapter Soft and Hard Event Logs.

Supported operating systems: Windows NT, O/S2, Netware, OpenServer, UnixWare, and DOS

Command:

IPSSSEND ERASEEVENT *Controller Options*

Replace:

- *Controller* with the ServeRAID controller number (1 to 8)
- *Options* with one of the following:
 - DEVICE for the Device Event Log
 - SOFT for the ServeRAID adapter or controller Soft Event Log
 - HARD for the ServeRAID adapter or controller Hard Event Log

FMSTATUS

Use the FMSTATUS command to display the progress of a format operation currently processing.

Supported operating system: DOS

Command:

IPSEND FMSTATUS *Controller Channel SID*

Replace:

- *Controller* with the ServeRAID controller number (1 to 8)
- *Channel* with the channel number for the device (1, 2, or 3)
- *SID* with the SCSI ID for the device (0 to 15)

FORMAT

Use the FORMAT command to perform a low-level format of a hard disk drive.

Attention:

When you issue this command, all data on the drive will be lost.

Supported operating system: DOS

Command:

IPSEND FORMAT *Controller Channel SID*

Replace:

- *Controller* with the ServeRAID controller number (1 to 8)
- *Channel* with the channel number for the device (1, 2, or 3)
- *SID* with the SCSI ID for the device (0 to 15)

GETEVENT

Use the GETEVENT command to display information about various unexpected events. IBM uses the Soft and Hard Event Logs for development and debugging purposes only. The Device Event Log contains event counters for each attached physical device. These counters include:

- Parity: An unexpected event while transferring data on the SCSI bus. This usually indicates a problem with the SCSI cable, connectors, or terminators.
- Soft: A SCSI device detected a *check condition* event.
- Hard: The SCSI controller detected an unexpected event. The controller is the most likely cause.
- Misc: The ServeRAID adapter or controller detected an event that was most likely caused by the device.

The Device Event Log also provides predictive failure analysis (PFA) alerts, which indicate that the device has signaled the ServeRAID adapter or controller that it might fail in the near future.

Supported Operating Systems: Windows NT, OS/2, NetWare, OpenServer, UnixWare, and DOS

Command:

```
IPSSEND GETEVENT Controller Options
```

Replace:

- *Controller* with the ServeRAID controller number (1 to 8)
- *Options* with one of the following: DEVICE for Device Event Log, SOFT for the ServeRAID adapter or controller Soft Event Log, or HARD for the ServeRAID adapter or controller Hard Event Log.

SELFTEST The SELFTEST command is used to direct an adapter or a device to perform its self-test.

Supported operating systems: DOS

Command:

IPSEND SELFTEST *Controller Options*

Replace:

- *Controller* with the ServeRAID controller number (1 to 8)
- *Options* with AD for the ServeRAID adapter or controller self-test or PD Channel SID for the Device self-test.

Note: *Channel* represents the drive channel and *SID* represents the SCSI ID for the device.

STARTDELY Use the STARTDELY command to set the number of drives in a group to start up simultaneously and to set the delay in seconds between the startup of these groups of drives.

Supported operating systems: DOS

Command:

IPSEND STARTDELY *Controller Options*

Replace:

- *Controller* with the ServeRAID controller number (1 to 8)
- *Options* with a question mark (?) to display concurrent drive startup count: Drive Count (1 to 16) and Delay Time (3 to 15 seconds).

RAID Configuration Commands

The IPSSSEND RAID configuration commands include the following:

DRIVEVER Use the DRIVEVER command to display the vendor ID, microcode version, and serial number of a SCSI device. The IPSSSEND program retrieves this information directly from the device.

Supported operating systems: Windows NT, OS/2, NetWare, OpenServer, UnixWare, and DOS

Command:

IPSSSEND DRIVEVER *Controller Channel SID*

Replace:

- *Controller* with the ServeRAID controller number (1 to 8)
- *Channel* with the channel number for the device (1, 2, or 3)
- *SID* with the SCSI ID for the device (0 to 15)

GETCONFIG Use the GETCONFIG command to display the ServeRAID adapter or controller configuration information. This includes information about the firmware version; initiator ID and rebuild rate; logical drive status, RAID level, and size; and physical device type, SCSI ID, and PFA error.

Supported operating systems: Windows NT, OS/2, NetWare, OpenServer, UnixWare, and DOS

Command:

IPSSSEND GETCONFIG *Controller Options*

Replace:

- *Controller* with the ServeRAID controller number (1 to 8)
- *Options* with one of the following: AD for adapter or controller information, LD for logical drive information, PD for physical device information, AL (default) for all information.

HSREBUILD Use the HSREBUILD command to set the ServeRAID adapter or controller hot-swap rebuild feature on. Use a question mark (?) to display the current status of the hot-swap rebuild feature.

Supported operating systems: Windows NT, OS/2, NetWare, OpenServer, UnixWare, and DOS

Command:

IPSEND HSREBUILD *Controller Options*

Replace:

- *Controller* with the ServeRAID controller number (1 to 8)
- *Options* with ON to enable the hot-swap rebuild feature, or ? to display the status of the hot-swap rebuild feature.

Starting the IPSMON Program

You can run the IPSMON program from the operating system command line.

To start the IPSMON program:

- If you are using OS/2 or Windows NT:

1. Type:

```
c:\ipsadm\ipsmon
```

2. Press **Enter**.

Note: The *c* represents the drive where OS/2 or Windows NT is installed.

- If you are using Novell NetWare:

1. From the console, type:

```
load ipsmon
```

2. Press **Enter**.

- If you are using SCO OpenServer or UnixWare:
 1. Type:
`/usr/bin/ipsmon`
 2. Press **Enter**.

Using the IPSMON Program

When you start this monitoring program, it immediately begins polling all ServeRAID adapters and controllers for specific conditions. If a condition being monitored is found, this program logs a message to the monitor, to a file, or to both the monitor and a file.

The IPSMON program uses command-line parameters to determine where to log the messages. If you need help, you can type the `IPSMON -?` command for a list of valid parameters.

If you start this program without any command-line parameters, the IPSMON program will log the messages to the `IPSMON.LOG` file, and the messages will not appear on the monitor.

The valid parameters for IPSMON are:

- **-f:filename**
Use the `-f` parameter to specify the name of the file in which to record messages. The default file name is `IPSMON.LOG`.
- **-s**
Use the `-s` parameter to display messages on the standard output (usually the monitor).
- **-?**
Use the `-?` parameter to obtain a current list of valid parameters.

After you start the IPSMON program, the program will continuously poll the ServeRAID adapters and controllers until you take one of the following actions:

- If you are using Windows NT or OS/2, press **Ctrl+C**.

- If you are using NetWare, type: `unload ipsmon` at the system console.
- If you are using OpenServer or UnixWare, press the **Del** key to cancel the program.

During operation, the program will log various messages. Each message will contain an alert code and a location specifier.

- The alert code begins with the message type and number. For example, INF, WRN, or CRT, followed by the message number.
- After the alert code comes the location specifier:
 - A** specifies the adapter or controller number
 - SID** specifies the SCSI ID (if required)
 - C** specifies the channel number (if required)

For example, a message of CRTxxx:A2C3SID04 signifies that a Critical condition (CRTxxx) was found on Adapter 2 (A2), Channel 3 (C3), SCSI ID 4 (SID04).

The IPSMON program can log the following messages, based on the required condition.

Information Messages:

```
<Date and Time> INF000:A1C-SID-- no errors detected
<Date and Time> INF001:A1C-SID-- rebuild started
<Date and Time> INF002:A1C-SID-- rebuild completed
<Date and Time> INF003:A1C-SID-- synchronization started
<Date and Time> INF004:A1C-SID-- synchronization completed
<Date and Time> INF005:A1C-SID-- migration started
<Date and Time> INF006:A1C-SID-- migration completed
```

Warning Messages:

```
<Date and Time> WRN001:A2C3SID12 PFA Error detected
```

Critical Messages:

```
<Date and Time> CRT001:A3C2SID04 dead drive detected
<Date and Time> CRT002:A1C-SID-- not responding to commands
```

Chapter 6. Solving ServeRAID Problems

This chapter describes the ServeRAID text and numeric messages that might appear during startup. This chapter also includes some basic information about rebuilding a defunct drive.

In addition to the information provided in this chapter, you might want to use the ServeRAID IPSSSEND program to help isolate ServeRAID problems. See “Using the IPSSSEND Program” on page 127 and “Problem-Isolation and Debug Commands” on page 133 for information about using the IPSSSEND program.

This chapter contains:

ServeRAID Adapter and Controller Messages	142
ServeRAID Startup Messages	142
ServeRAID POST Messages	150
ServeRAID ISPR, BCS, and ECS Codes	151
ISPR (Interrupt Status Port Register) Codes	152
Basic and Extended Configuration Status Codes	153
Rebuilding a Defunct Drive	159
Guidelines for the Rebuild Operation	159
General Information about the Rebuild Operation	160
Automatically Rebuilding the Defunct Drive	160

ServeRAID Adapter and Controller Messages

This section lists the ServeRAID messages that might appear during system startup.

The ServeRAID adapters and controllers provide a Device Event Log that collects statistics on the number and types of events that occur on a selected hard disk drive. After correcting a problem with the disk array, clear the log so that you can identify any subsequent errors quickly. For information about clearing the event log, see “ERASEEVENT” on page 133.

All hard disk drives contain unique identifiers, such as the drive serial number and manufacturer. During configuration, the ServeRAID adapter or controller stores this information.

ServeRAID Startup Messages

During power-on self-test (POST), the ServeRAID adapter or controller compares the stored configuration information to the configuration that is actually present. If a discrepancy exists, one or more status messages appear after POST completes, but before the operating system loads.

Notes:

1. When the ServeRAID adapter or controller requires your input, a list of function keys will appear below the message.
2. Where the “Action” information tells you to start the IBM ServeRAID configuration program, insert the *IBM ServeRAID Configuration CD* into the CD-ROM drive; then, restart the server. The action column also provides general information about the message.
3. Where *SID* and *ch* appear in these messages, *SID* shows the SCSI ID for the device and *ch* shows the channel to which the device is attached.
4. Where *m* or *n* appears in these messages, a number will appear in the actual message.

This following pages list, in alphabetical order, messages associated with the ServeRAID subsystem.

A new drive was installed.

Explanation: When the ServeRAID adapter or controller detects a new drive that is not part of the current configuration, the following message appears:

Following new drives found (old state: new state: ch: SID)

Action: This is an information message. No action is required.

Auto rearrange.

Explanation: Auto rearrange is enabled or disabled.

Action: This is an information message. No action is required.

Configured drives are missing.

Explanation: When the ServeRAID adapter or controller detects that a previously configured drive is missing, the following message appears:

Following drives not responding (old state: new state: ch: SID)

Where: **old state** is the configured state of the drive.

new state is the state that the ServeRAID adapter or controller will assign to the drive.

ch is the channel where the drive was located previously.

SID is the SCSI ID for where the drive was located previously.

Examples of the possible state changes include:

Online to Defunct	(ONL: DDD x: y)
Ready to Empty	(RDY: EMP x: y)
Standby to Empty	(SBY: EMP x: y)
Rebuild to Defunct	(RBL: DDD x: y)
Hot Spare to Defunct	(HSP: DHS x: y)
Standby Hot Spare to Defunct	(SHS: DHS x: y)

Action: Press one of the following keys:

F4 Retry. Press this key after correcting a problem. For example, press F4 after you turn on the external storage enclosure that contains the hard disk drive.

F5 Accept. Press this key to accept the new state that the ServeRAID adapter or controller will assign to the drive. For example, the ServeRAID adapter or controller will assign the drive a state of defunct (DDD) or empty (EMP).

You can also press F5 when you must remove a drive, RAID level-1 and RAID level-5 logical drives are present, and performance in a degraded mode is acceptable. The ServeRAID adapter or controller will assign the drive a state of defunct (DDD), but the server can complete startup. However, the array will remain in Critical mode and the potential for data loss will exist until you replace and rebuild the defunct drive. To prevent the loss of data, replace and rebuild the defunct drive in a timely manner.

Note: A hard disk drive in the DDD state does not necessarily mean that you need to replace the drive. Before you replace the drive, ensure that:

1. All cables are connected properly to the backplane and to the hard disk drive. Also, ensure that all cables inside the server are connected properly.
2. The hot-swap drive trays are seated properly in the drive bay.
3. If you have not already attempted to rebuild the drive, try rebuilding it. See "Rebuilding a Defunct Drive" on page 159 for more information.

After you perform these steps, if the hard disk drive does not function properly, replace the drive.

F10 Continue. Press this key to continue without change to the configuration.

Configured drives are not in the configured location.

Explanation: This message will be preceded by the previous messages and the **F5** key choice because configured drives were not found in the configured location. When the ServeRAID adapter or controller detects that a previously configured drive is present, but the drive is in a new location, the following message appears:

Following drives found in new location (old ch: old SID: > new ch: new SID)

Where: **old ch** is the channel that matches the existing drive configuration information.

old SID is the SCSI ID that matches the existing drive configuration information.

new ch is the channel where the drive is now located.

new SID is the SCSI ID where the drive is now located.

For example:

(1 :5 > 1: 14)

In this example, the message indicates that the drive from Channel 1, SCSI ID 5 is now located at Channel 1, SCSI ID 14. The drive might have been physically moved to the new drive bay.

Action: Press one of the following keys:

- F4** Retry. Press this key after correcting a problem. For example, press F4 after you move the hard disk drive to its previously assigned location.
- F5** Accept. Press this key to accept the new state that the ServeRAID adapter or controller will assign to the drive. For example, the ServeRAID adapter or controller will assign the drive a state of defunct (DDD) or empty.

Note: A hard disk drive in the DDD state does not necessarily mean that you need to replace the drive. Before you replace the drive, ensure that:

1. All cables are connected properly to the backplane and to the hard disk drive. Also, ensure that all cables inside the server are connected properly.
2. The hot-swap drive trays are seated properly in the drive bay.
3. If you have not already attempted to rebuild the drive, try rebuilding it. See "Rebuilding a Defunct Drive" on page 159 for more information.

After you perform these steps, if the hard disk drive does not function properly, replace the drive.

- F6** Modify. Press this key to modify the configuration to match the current drive location.

You might remove the hot-swap drives from the server for security or maintenance reasons. If you replace the drives but install them in different drive bays, you can press **F6** to accept the new locations, and the ServeRAID adapter or controller will update the configuration.

Controller is not responding to commands. No logical drives are installed.

Explanation: The ServeRAID adapter or controller is not operational.

Action: Have the system serviced.

Error: Cannot disable this adapter BIOS.

Explanation: The ServeRAID adapter or controller was unable to prevent an extra copy of its BIOS code from being stored on the server. This condition occurs when the server contains multiple ServeRAID adapters or controllers.

Action: This is an information message. No action is required.

Following drives not responding (old state: new state ch: SID)

Explanation: One or more drives did not respond to the ServeRAID adapter or controller. For example, the ServeRAID adapter or controller detected a new drive at an unconfigured SCSI ID, and the drive is not part of the current configuration. This might also occur if the ServeRAID adapter or controller detected that a configured drive is missing.

Action: Select **F5** to accept the new state that the ServeRAID adapter or controller will assign to the drive. For example, the ServeRAID adapter or controller will assign the drive a state of defunct (DDD) or empty (EMP).

A hard disk drive in the defunct state does not necessarily mean that you need to replace the drive. Before you replace the drive, ensure that:

1. All cables are connected properly to the backplane or system board, and to the hard disk drive. Also, ensure that all cables inside the server are connected properly.
2. The hot-swap drive trays are seated properly in the drive bay.
3. If you have not already attempted to rebuild the drive, try rebuilding it. See "Rebuilding a Defunct Drive" on page 159 for more information.

After you perform these steps, if the hard disk drive does not function properly, replace the drive.

For more information, see "Configured drives are missing." on page 143.

Following drives found in new location (old ch: old SID > new ch:
new SID)

Explanation: POST found that the location of one or more drives does not match the stored configuration information.

Action: For more information, see “Configured drives are not in the configured location.” on page 144.

Following new drives found (old state: new state ch: SID)

Explanation: One or more drives were found at an unconfigured SCSI ID. For each drive listed, a new state of Ready (RDY) appears.

Action: This is an information message. No action is required.

Installation stopped.

Explanation: The server cannot access the ServeRAID adapter or controller.

Action: This is a follow-on message to a preceding message. Follow the “Action” instructions for the preceding message to resolve the problem.

n logical drives are installed.

Explanation: *n* represents the number of defined logical drives.

Action: This is an information message. No action is required.

New adapter installed in a configured server or drives are imported

Explanation: This message might be preceded by the previous two messages and the **F5** and **F6** key choices because the drives were not found in the configured location. When the ServeRAID adapter or controller detects that the identifiers of the drives do not match the adapter configuration information, the following message appears:

Following new drives found: (host id: old ch: old SID: new ch: new SID)

Where: **host id** identifies the System Name where the ServeRAID adapter or controller resides.

old ch is the channel that matches the drive configuration information.

old SID is the SCSI ID that matches the drive configuration information.

new ch is the channel where the drive is now located.

new SID is the SCSI ID where the drive is now located.

For example, when drivers are imported from a server with the System Name of *My Machine*: (My Machine: 1:6 > 1:10)

In this example, the message indicates that the drive from Channel 1, SCSI ID 6 is now located at Channel 1, SCSI ID 10. The drive might have been physically moved to a new drive bay.

Action: Press one of the following keys:

- F4** Retry. Press this key after correcting the problem. For example, press F4 after you move the hard disk drive to its previously assigned location, or after you install the original hard disk drives back in the server.
- F5** Accept. Press this key to accept the new state that the ServeRAID adapter or controller will assign to the drive. For example, the ServeRAID adapter or controller will assign the drive a state of defunct (DDD) or empty (EMP).

Note: A hard disk drive in the defunct state does not necessarily mean that you need to replace the drive. Before you replace the drive, ensure that:

1. All cables are connected properly to the backplane or system board, and to the hard disk drive. Also, ensure that all cables inside the server are connected properly.
2. The hot-swap drive trays are seated properly in the drive bay.
3. If you have not already attempted to rebuild the drive, try rebuilding it. See "Rebuilding a Defunct Drive" on page 159 for more information.

After you perform these steps, if the hard disk drive does not function properly, replace the drive.

- F6** Modify. This choice is not always active. Press this key to modify the configuration to match the current drive location.

You might remove the hot-swap drives from the server for security or maintenance reasons. If you replace the drives but install them in different drive bays, you can press **F6** to accept the new locations, and the ServeRAID adapter or controller will update the configuration.

- F7** Import. Press this key to import the configuration information from the drive and to update the configuration information for the ServeRAID adapter or controller. This choice is useful when you

replace the ServeRAID adapter or controller in an existing ServeRAID subsystem.

You also might press F7 if you replace a whole set of drives with drives that were configured in another server with a ServeRAID adapter or controller.

Note: When you install drives in a server that has no logical drives defined, the F7 choice will not appear. The ServeRAID adapter or controller does not contain any logical drives in its factory configuration. Therefore, F7 will not appear. In this case, do the following:

1. Restart the server and press **Ctrl+I** to enter the Mini-Configuration program (see “Using the ServeRAID Mini-Configuration Program” on page 51).
2. Select **Advanced Functions**.
3. Select **Import Configuration from Drives to Adapter** and follow the instructions on the screen.

NVRAM Cache Controller Not Responding

Explanation: BIOS code detected a bad or failed NVRAM.

Action: Press **F9** to remove the NVRAM cache controller from the configuration, or press **F10** to exit without change.

NVRAM Cache Controller Replacement

Explanation: The ServeRAID controller detects that the NVRAM cache controller is defective.

Action: Press **F8** if you replaced the NVRAM cache controller, or press **F10** if you have not replaced the NVRAM cache controller.

Recoverable configuration error

Explanation: The configuration data stored in NVRAM does not match the configuration data stored in the EEPROM.

Action:

1. Press **Ctrl+Alt+Del** to restart the system.
2. Start the ServeRAID Mini-Configuration Program. (See “Using the ServeRAID Mini-Configuration Program” on page 51 for instructions.)

3. Select **Advanced Functions** from the Main Menu; then, select **Import Configuration from Drive(s)**. (See “Using the Advanced Configuration Functions” on page 53 for more information.)

WARNING: *n* logical drives are critical; *n* logical drives are offline.

Explanation: One or more hard disk drives have failed.

Action: Replace the defunct drives as soon as possible to prevent data loss.

Your server has an error due to a Blocked Logical Drive.

Explanation: One or more logical drives are in a blocked state. A blocked logical drive cannot be accessed. See “Logical Drive State Descriptions” on page 37 for additional information.

Action: Press **F4** to unblock the logical drive, or press **F5** to continue without unblocking.

ServeRAID POST Messages

The following numeric POST messages appear in hexadecimal format.

1xxx to 7xxx

Explanation: The POST detected an internal error.

Action: Have the system serviced.

2601 to 260B

Explanation: The POST detected an error with the ServeRAID subsystem.

Action: Have the system serviced.

2610

Explanation: The POST detected an error with the ServeRAID adapter or controller hardware.

Action: Have the system serviced.

2620

Explanation: The POST detected that a ServeRAID configuration or hard disk error occurred.

Action: Start the *IBM ServeRAID Configuration CD* and view the existing device and configuration information for your ServeRAID subsystem. If you can not locate and correct the configuration problem or the failing device, or if the problem persists, have the system serviced.

8xxx to Bxxx

Explanation: The POST detected an error with the SCSI interface.

Action: Verify that the SCSI cables are correctly connected, and the SCSI termination is set properly for each installed SCSI device.

If you can not locate and correct the SCSI problem, or if the problem persists, have the system serviced.

ServeRAID ISPR, BCS, and ECS Codes

Once the ServeRAID POST completes, register information appears on the screen in hexadecimal format, as follows:

Hardware: ISPR=aaaa BCS=bb ECS=cc

ISPR displays the four digit Interrupt Status Report Register code, BCS displays the Basic Configuration Status Register code, and ECS displays the Extended Configuration Status Register code.

If no errors occur:

ISPR (aaaa) = EF10
BCS (bb) = 0F or 09
ECS (cc) = 00

If an error occurs, refer to: "ISPR (Interrupt Status Port Register) Codes" on page 152 for the ISPR error codes and "Basic and Extended Configuration Status Codes" on page 153 for the BCS and ECS error codes.

ISPR (Interrupt Status Port Register) Codes

1xxx

Explanation: A flash checksum error occurred.

Action: Have the system serviced.

2xxx

Explanation: A code DRAM error occurred.

Action: Have the system serviced.

3xxx

Explanation: A NVRAM error occurred.

Action: Have the system serviced.

4xxx

Explanation: A timer/cache memory controller error occurred.

Action: Have the system serviced.

5xxx

Explanation: A cache memory controller error occurred.

Action: Have the system serviced.

6xxx

Explanation: A cache DRAM error occurred.

Action: Have the system serviced.

7xxx

Explanation: A host/local PCI bus interface error occurred.

Action: Have the system serviced.

8xxx

Explanation: A SCSI I/O port error occurred.

Action: Have the system serviced.

9xxx

Explanation: A SCSI termination error occurred.

Action: Check cable connections and device termination. If the problem persists, have the system serviced.

Axxx

Explanation: A SCSI I/O port error occurred.

Action: Have the system serviced.

Bxxx

Explanation: A SCSI bus interface error occurred.

Action: Have the system serviced.

Basic and Extended Configuration Status Codes

BCS	ECS	Explanation and Possible Recovery Action
Code not in table	Code not in table	Explanation: The ServeRAID adapter or controller is not functioning properly. Action: Have the system serviced.
00	01	Explanation: Invalid flash configuration. Action: Start the <i>IBM ServeRAID Configuration CD</i> and follow the instructions that appear on the screen. If no instructions appear or if the problem persists, have the system serviced.
00	02	Explanation: Invalid NVRAM configuration. Action: Start the <i>IBM ServeRAID Configuration CD</i> and follow the instructions that appear on the screen. If no instructions appear or if the problem persists, have the system serviced.

BCS	ECS	Explanation and Possible Recovery Action
00	03	<p>Explanation: Invalid flash and NVRAM configuration.</p> <p>Action: Start the <i>IBM ServeRAID Configuration CD</i> and follow the instructions that appear on the screen.</p> <p>If no instructions appear or if the problem persists, have the system serviced.</p>
01	08	<p>Explanation: No configuration was found in drives or Online/Rebuild drives are not responding.</p> <p>Action: Press F4, F5, F7, or F10.</p>
01	18	<p>Explanation: No configuration was found in drives; or, Online/Rebuild and Hot-Spare/Standby Hot-Spare drives are not responding.</p> <p>Action: Press F4, F5, F7, or F10.</p>
01	28	<p>Explanation: No configuration was found in drives; or, Online/Rebuild and Ready/Standby drives are not responding.</p> <p>Action: Press F4, F5, F7, or F10.</p>
01	38	<p>Explanation: No configuration was found in drives; or, Online/Rebuild, Hot-Spare/Standby Hot-Spare, and Ready/Standby drives are not responding.</p> <p>Action: Press F4, F5, F7, or F10.</p>
01	48	<p>Explanation: No configuration was found in drives; or, Online/Rebuild drives are not responding and unidentified drives were found.</p> <p>Action: Press F4, F5, F7, or F10.</p>
01	58	<p>Explanation: No configuration was found in drives; or, Online/Rebuild and Hot-Spare/Standby Hot-Spare drives are not responding and unidentified drives were found.</p> <p>Action: Press F4, F5, F7, or F10.</p>
01	68	<p>Explanation: No configuration was found in drives; or, Online/Rebuild and Ready/Standby drives are not responding and unidentified drives were found.</p> <p>Action: Press F4, F5, F7, or F10.</p>

BCS	ECS	Explanation and Possible Recovery Action
01	78	<p>Explanation: No configuration was found in drives; or, Online/Rebuild, Hot-Spare/Standby Hot-Spare, and Ready/Standby drives are not responding and unidentified drives were found.</p> <p>Action: Press F4, F5, F7, or F10.</p>
03	88	<p>Explanation: A drive was imported from another system and it has valid configuration; and, Online/Rebuild drives are not responding.</p> <p>Action: Press F4, F5, F7, or F10.</p>
03	98	<p>Explanation: A drive was imported from another system and it has valid configuration; and, Online/Rebuild and Hot Spare/Standby Hot-Spare drives are not responding.</p> <p>Action: Press F4, F5, F7, or F10.</p>
03	A8	<p>Explanation: A drive was imported from another system and it has valid configuration; and, Online/Rebuild and Ready/Standby drives are not responding.</p> <p>Action: Press F4, F5, F7, or F10.</p>
03	B8	<p>Explanation: A drive was imported from another system and it has valid configuration; and, Online/Rebuild, Hot-Spare/Standby Hot-Spare, and Ready/Standby drives are not responding.</p> <p>Action: Press F4, F5, F7, or F10.</p>
03	C8	<p>Explanation: A drive was imported from another system and it has valid configuration; and, Online/Rebuild drives are not responding and unidentified drives were found.</p> <p>Action: Press F4, F5, F7, or F10.</p>
03	D8	<p>Explanation: A drive was imported from another system and it has valid configuration; and, Online/Rebuild and Hot-Spare/Standby Hot-Spare drives are not responding and unidentified drives were found.</p> <p>Action: Press F4, F5, F7, or F10.</p>

BCS	ECS	Explanation and Possible Recovery Action
03	E8	<p>Explanation: A drive was imported from another system and it has valid configuration; and, Online/Rebuild and Ready/Standby drives are not responding and unidentified drives were found.</p> <p>Action: Press F4, F5, F7, or F10.</p>
03	F8	<p>Explanation: A drive was imported from another system and it has valid configuration; and, Online/Rebuild, Hot-Spare/Standby Hot-Spare, and Ready/Standby drives are not responding and unidentified drives were found.</p> <p>Action: Press F4, F5, F7, or F10.</p>
07	08	<p>Explanation: Online/Rebuild drives are not responding.</p> <p>Action: Press F4, F5, or F10.</p>
07	0C	<p>Explanation: Online/Rebuild drives are not responding and a drive was found at the incorrect SCSI ID.</p> <p>Action: Press F4, F5, F6, or F10.</p>
07	18	<p>Explanation: Online/Rebuild and Hot-Spare/Standby Hot-Spare drives are not responding.</p> <p>Action: Press F4, F5, or F10.</p>
07	1C	<p>Explanation: Online/Rebuild and Hot Spare/Standby Hot-Spare drives are not responding and a drive was found at the incorrect SCSI ID.</p> <p>Action: Press F4, F5, F6, or F10.</p>
07	28	<p>Explanation: Online/Rebuild and Ready/Standby drives are not responding.</p> <p>Action: Press F4, F5, or F10.</p>
07	2C	<p>Explanation: Online/Rebuild and Ready/Standby drives are not responding; and, a drive was found at the incorrect SCSI ID.</p> <p>Action: Press F4, F5, F6, or F10.</p>
07	38	<p>Explanation: Online/Rebuild, Ready/Standby, and Hot-Spare/Standby Hot-Spare drives are not responding.</p> <p>Action: Press F4, F5, or F10.</p>

BCS	ECS	Explanation and Possible Recovery Action
07	3C	<p>Explanation: Online/Rebuild, Ready/Standby, and Hot-Spare/Standby Hot-Spare drives are not responding; and, a drive was found at the incorrect SCSI ID.</p> <p>Action: Press F4, F5, F6, or F10.</p>
07	48	<p>Explanation: Online/Rebuild drives are not responding and unidentified drives were found.</p> <p>Action: Press F4, F5, or F10.</p>
07	4C	<p>Explanation: Online/Rebuild drives are not responding, a drive was found at the incorrect SCSI ID, and unidentified drives were found.</p> <p>Action: Press F4, F5, F6, or F10.</p>
07	58	<p>Explanation: Online/Rebuild and Hot Spare/Standby Hot-Spare drives are not responding; and, unidentified drives were found.</p> <p>Action: Press F4, F5, or F10.</p>
07	5C	<p>Explanation: Online/Rebuild and Hot Spare/Standby Hot-Spare drives are not responding, a drive was found at the incorrect SCSI ID, and unidentified drives were found.</p> <p>Action: Press F4, F5, F6, or F10.</p>
07	68	<p>Explanation: Online/Rebuild and Ready/Standby drives are not responding; and, unidentified drives were found.</p> <p>Action: Press F4, F5, or F10.</p>
07	6C	<p>Explanation: Online/Rebuild and Ready/Standby drives are not responding, a drive was found at the incorrect SCSI ID, and unidentified drives were found.</p> <p>Action: Press F4, F5, F6, or F10.</p>
07	78	<p>Explanation: Online/Rebuild, Ready/Standby, and Hot-Spare/Standby Hot-Spare drives are not responding; and, unidentified drives were found.</p> <p>Action: Press F4, F5, or F10.</p>

BCS	ECS	Explanation and Possible Recovery Action
07	7C	<p>Explanation: Online/Rebuild, Ready/Standby, and Hot-Spare/Standby Hot-Spare drives are not responding, a drive was found at the incorrect SCSI ID, and unidentified drives were found.</p> <p>Action: Press F4, F5, F6, or F10.</p>
09	00	<p>Explanation: No error occurred.</p> <p>Action: No action is required.</p>
09	10	<p>Explanation: Hot-Spare/Standby Hot-Spare drives are not responding.</p> <p>Action: Press F4, F5, or F10.</p>
09	20	<p>Explanation: Ready/Standby drives are not responding.</p> <p>Action: Press F4, F5, or F10.</p>
09	30	<p>Explanation: Hot-Spare/Standby Hot-Spare and Ready/Standby drives are not responding.</p> <p>Action: Press F4, F5, or F10.</p>
0F	00	<p>Explanation: No error occurred.</p> <p>Action: No action is required.</p>
0F	10	<p>Explanation: Hot-Spare/Standby Hot-Spare drives are not responding.</p> <p>Action: Press F4, F5, or F10.</p>
0F	20	<p>Explanation: Ready/Standby drives are not responding.</p> <p>Action: Press F4, F5, or F10.</p>
0F	30	<p>Explanation: Hot-Spare/Standby Hot-Spare and Ready/Standby drives are not responding.</p> <p>Action: Press F4, F5, or F10.</p>

Rebuilding a Defunct Drive

When a hard disk drive goes defunct (DDD), a Rebuild operation is required to reconstruct the data for the device in its respective disk array. The ServeRAID adapters and controllers can reconstruct RAID level-1 and RAID level-5 logical drives, but they cannot reconstruct data stored in RAID level-0 logical drives.

To prevent data integrity problems, the ServeRAID adapters and controllers set the RAID level-0 logical drives to *Blocked* during a Rebuild operation. After the Rebuild operation completes, you can unblock the RAID level-0 logical drives, and access them once again. But remember, the logical drive might contain damaged data. (Refer to “Unlocking Logical Drives” on page 111 for more information.)

Before you rebuild a drive, review the following guidelines and general information.

Guidelines for the Rebuild Operation

- The replacement hard disk drive must have a capacity equal to or greater than the failed drive.
- If the hard disk drive being rebuilt is part of a RAID level-0 logical drive, the RAID level-0 drive is blocked.
 - You must unblock any RAID level-0 logical drives at the end of the rebuild operation.
 - If you use the Administration and Monitoring program to initiate the rebuild operation, you can unblock the blocked RAID level-0 drive when the rebuild operation completes. (See “Unlocking Logical Drives” on page 111 for more information.)
- Data in a logical drive with RAID level-0 is lost during the rebuild operation. If you backed up your data before the drive failed, you can restore the data to the new drive.

General Information about the Rebuild Operation

A physical hard disk drive can enter the rebuild state if:

- You physically replace a defunct drive that is part of the critical logical drive.

When you physically replace a defunct drive in a critical logical drive, the ServeRAID adapter or controller rebuilds the data on the new physical drive *before* it changes the logical drive state back to Okay.

- The ServeRAID adapter or controller adds a hot-spare or a standby hot-spare drive to the array and changes its state from Hot-Spare or Standby Hot-Spare to Rebuilding.

Automatically Rebuilding the Defunct Drive

The ServeRAID adapter or controller will rebuild a defunct drive automatically when all of the following conditions exist:

- The physical drive that failed is part of a RAID level-1 or RAID level-5 logical drive.
- A hot-spare or standby hot-spare drive with a capacity equal to or greater than the capacity of the defunct drive is available the moment the drive fails.
 - When multiple hot-spare drives are available, the ServeRAID adapter or controller searches for a hot-spare drive of the appropriate size. The smallest drive that meets this requirement enters the Rebuild state.
 - If no hot-spare or standby hot-spare drives are available, the rebuild operation will start the moment you replace the defective drive.

Note: If you physically replace the drive and the new drive does not appear in the Physical Drives branch of the Main Tree, you must scan for new or removed Ready drives.

- No rebuild, synchronization, or logical-drive migration operation is in process.

Chapter 7. Getting Help, Service, and Information

If you need help, service, technical assistance, or just want more information about IBM products, you will find a wide variety of sources available from IBM to assist you.

For example, IBM maintains pages on the World Wide Web where you can get information about IBM products and services, find the latest technical information, and download device drivers and updates.

Help is also available from bulletin boards and online services, as well as by fax and telephone. This section provides information about these sources.

Services available and telephone numbers listed are subject to change without notice.

This chapter contains:

Before You Call for Service	162
Getting Customer Support and Service	162
Using Electronic Support Services	162
Using the World Wide Web	163
Getting Information by Fax	164
Getting Help Online	164
Getting Help by Telephone	165
Getting Help Around the World	167
Purchasing Additional Services	167
900-Number Operating System and Hardware Support Line	167
Network and Server Support Line	168
Ordering Support Line Services	168
Warranty and Repair Services	169
Ordering Publications	170

Before You Call for Service

Many computer problems can be solved without outside assistance, by using the online help or by looking in the online or printed documentation that comes with your computer or software. Also, be sure to read the information in any README files that come with your software.

Most computers, operating systems, and application programs come with documentation that contains troubleshooting procedures and explanations of error messages. The documentation that comes with your computer also contains information about the diagnostic tests you can perform.

If you receive a POST error code when you turn on your computer, refer to the POST error-message charts in your hardware documentation. If you do not receive a POST error code, but suspect a hardware problem, refer to the troubleshooting information in your hardware documentation or run the diagnostic tests.

If you suspect a software problem, consult the documentation (including README files) for the operating system or application program.

Getting Customer Support and Service

Purchasing an IBM Netfinity hardware product entitles you to standard help and support during the warranty period. If you need additional support and services, a wide variety of extended services are available for purchase that address almost any need.

Using Electronic Support Services

If you have a modem, you can get help from several popular services. Bulletin boards and online information services provide assistance through question-and-answer message areas, live chat rooms, searchable databases, and more.

Technical information is available on a wide range of topics. In addition, the latest device driver updates are available.

The IBM Bulletin Board System (BBS) can be reached 24 hours a day, 7 days a week. Modem speeds of up to 14 400 baud are supported. Long distance telephone charges might apply. To access the IBM BBS:

- In the U.S., call 1-919-517-0001.
- In Canada:
 - In Montreal, call 514-938-3022.
 - In Toronto, call 905-316-4255 or 416-956-7877.
 - In Vancouver, call 604-664-6464.
- In the U.K., call 01256 336655.

Using the World Wide Web

On the World Wide Web, the IBM Personal Computing Web site has up-to-date information about IBM Personal Computer products and support. The address for the IBM Personal Computing home page is:

<http://www.pc.ibm.com>

You can find support information for your IBM products, including supported options, on the IBM Personal Computing Support page at:

<http://www.pc.ibm.com/support>

If you select Profile from the support page, you can create a customized support page that is specific to your hardware, complete with Frequently Asked Questions, Parts Information, Technical Hints and Tips, and Downloadable Files. You will have the information you need, all in one place. In addition, you can choose to receive e-mail notifications whenever new information becomes available about your registered products. You also can access online support forums, which are community sites monitored by IBM support staff.

For information about specific Personal Computer products, visit the following pages:

<http://www.pc.ibm.com/us/netfinity/>

<http://www.pc.ibm.com/us/desktop/>

<http://www.pc.ibm.com/us/intellistation/>

<http://www.pc.ibm.com/us/thinkpad/>

<http://www.pc.ibm.com/us/options/>

<http://www.pc.ibm.com/us/aptiva/>

You can select a country-specific Web site from these pages.

Getting Information by Fax

If you have a touch-tone telephone and access to a fax machine, in the U.S. and Canada you can receive by fax marketing and technical information on many topics, including hardware, operating systems, and local area networks (LANs). You can call the IBM Automated Fax System 24 hours a day, 7 days a week. Follow the recorded instructions, and the requested information will be sent to your fax machine.

To access the IBM Automated Fax System, do the following:

- In the U.S., call 1-800-426-3395.
- In Canada, call 1-800-465-3299.

Getting Help Online

Online Housecall is a remote communication tool that allows an IBM technical-support representative to access your system by modem. Many problems can be remotely diagnosed and corrected quickly and easily. In addition to a modem, a remote-access application program is required. This service is not available for servers. There might be a charge for this service, depending on the request.

For more information about configuring your system for Online Housecall:

- In the U.S., call 1-800-772-2227.

- In Canada, call 1-800-565-3344.
- In all other countries, contact your IBM reseller or IBM marketing representative.

Getting Help by Telephone

During the warranty period, you can get help and information by telephone through the IBM PC HelpCenter. Expert technical-support representatives are available to assist you with questions you might have on the following:

- Setting up your computer and IBM monitor
- Installing and setting up IBM options purchased from IBM or an IBM reseller
- Arranging for service (on-site or carry-in)
- Arranging for overnight shipment of customer-replaceable parts

In addition, if you purchased an IBM PC Server or IBM Netfinity Server, you are eligible for IBM Start Up Support for 90 days after installation. This service provides assistance for:

- Setting up your network operating system
- Installing and configuring interface cards
- Installing and configuring network adapters

Please have the following information ready when you call:

- Machine Type and Model
- Serial numbers of your computer, monitor, and other components, or your proof of purchase
- Description of the problem
- Exact wording of any error messages
- Hardware and software configuration information for your system

If possible, be at your computer when you call.

These services are available 24 hours a day, 7 days a week.⁴

⁴ Response time will vary depending on the number and complexity of incoming calls.

Country		Telephone number
Austria	Österreich	1-546 585 075
Belgium - Dutch	Belgie	02-717-2504
Belgium - French	Belgique	02-717-2503
Canada	Canada	1-800-565-3344
Denmark	Danmark	03-525-6905
Finland	Suomi	9-22-931805
France	France	01-69-32-40-03
Germany	Deutschland	069-6654-9003
Ireland	Ireland	01-815-9207
Italy	Italia	02-4827-5003
Luxembourg	Luxembourg	298-977-5060
Netherlands	Nederland	020-504-0531
Norway	Norge	2-305-3203
Portugal	Portugal	01-791-5147
Spain	España	091-662-4270
Sweden	Sverige	08-632-0063
Switzerland - German	Schweiz	01-212-1810
Switzerland - French	Suisse	022-310-0418
Switzerland - Italian	Svizzera	091-971-0523
United Kingdom	United Kingdom	01475-555555
U.S.A. and Puerto Rico	U.S.A. and Puerto Rico	1-800-772-2227

In all other countries, contact your IBM reseller or IBM marketing representative.

Getting Help Around the World

If you travel with your computer or need to move it to another country, you can register for International Warranty Service. When you register with the International Warranty Service Office, you will receive an International Warranty Service Certificate that is honored virtually worldwide, wherever IBM or IBM resellers sell and service IBM PC products.

For more information or to register for International Warranty Service:

- In the U.S. or Canada, call 1-800-497-7426.
- In Europe, call 44-1475-893638 (Greenock, U.K.).
- In Australia and New Zealand, call 61-2-9354-4171.

In all other countries, contact your IBM reseller or IBM marketing representative.

Purchasing Additional Services

During and after the warranty period, you can purchase additional services, such as support for IBM and non-IBM hardware, operating systems, and application programs; network setup and configuration; upgraded or extended hardware repair services; and custom installations. Service availability and name might vary by country.

900-Number Operating System and Hardware Support Line

In the U.S., if you prefer to obtain technical support on a pay-as-you-go basis, you can use the 900-number support line. The 900-number support line provides support for IBM PC products that are out of the warranty period.

To access this support, call 1-900-555-CLUB (2582). You will be notified of the charge per minute.

Network and Server Support Line

Network and Server Support is available for simple or complex networks made up of IBM servers and workstations using major network operating systems. In addition, many popular non-IBM adapters and network interface cards are supported.

This service includes all of the features of the Enhanced PC Support Line, plus:

- Installing and configuring client workstations and servers
- Identifying system problems and correcting problems on the client or the server
- Using IBM and non-IBM network operating systems
- Interpreting documentation

You can purchase this service on a per-call basis, as a multiple-incident package, or as an annual contract with a 10-incident limit. For more information about purchasing Network and Server Support, see “Ordering Support Line Services.”

Ordering Support Line Services

The Network and Server Support Line services are available for products on the Supported Products list. To receive a Supported Products list:

- In the U.S.:
 1. Call 1-800-426-3395.
 2. Select document number 11683 for Network and Server support.
- In Canada, contact IBM Direct at 1-800-465-7999, or:
 1. Call 1-800-465-3299.
 2. Select the HelpWare catalog.
- In all other countries, contact your IBM reseller or IBM marketing representative.

For more information or to purchase these services:

- In the U.S., call 1-800-772-2227.

- In Canada, call 1-800-465-7999.
- In all other countries, contact your IBM reseller or IBM marketing representative.

Warranty and Repair Services

You can upgrade your standard hardware warranty service or extend the service beyond the warranty period.

Warranty upgrades in the U.S. include:

- Carry-in service to on-site service

If your warranty provides carry-in repair service, you can upgrade to on-site repair service, either standard or premium. The standard upgrade provides a trained servicer within the next business day (9 a.m. to 5 p.m., local time, Monday through Friday). The premium upgrade provides 4-hour average response, 24 hours a day, 7 days a week.

- On-site service to premium on-site service

If your warranty provides for on-site service, you can upgrade to premium on-site service (4-hour average on-site response, 24 hours a day, 7 days a week).

You also can extend your warranty. Warranty and Repair Services offers a variety of post-warranty maintenance options, including ThinkPad EasyServ Maintenance Agreements. Availability of the services varies by product.

For more information about warranty upgrades and extensions:

- In the U.S., call 1-800-426-4968.
- In Canada, call 1-800-465-7999.
- In all other countries, contact your IBM reseller or IBM marketing representative.

Ordering Publications

Additional publications are available for purchase from IBM. For a list of publications available in your country:

- In the U.S., Canada, and Puerto Rico, call 1-800-879-2755.
- In other countries, contact your IBM reseller or IBM marketing representative.

Appendix A. Product Warranties and Notices

This appendix contains warranty statements, emissions notices, general-information notices, and trademarks.

Warranty Statements

The warranty statements consist of two parts: Part 1 and Part 2. Part 1 varies by country. Part 2 is the same for both statements. Be sure to read both the Part 1 that applies to your country and Part 2.

- **United States, Puerto Rico, and Canada (Z125-4753-05 11/97)**
(Part 1 - General Terms on page 171)
- **Worldwide except Canada, Puerto Rico, Turkey, and United States (Z125-5697-01 11/97)**
(Part 1 - General Terms on page 175)
- **Worldwide Country-Unique Terms**
(Part 2 - Country-Unique Terms on page 178)

IBM Statement of Limited Warranty for United States, Puerto Rico, and Canada (Part 1 - General Terms)

This Statement of Limited Warranty includes Part 1 - General Terms and Part 2 - Country-unique Terms. The terms of Part 2 may replace or modify those of Part 1. The warranties provided by IBM in this Statement of Limited Warranty apply only to Machines you purchase for your use, and not for resale, from IBM or your reseller. The term "Machine" means an IBM machine, its features, conversions, upgrades, elements, or accessories, or any combination of them. The term "Machine" does not include any software programs, whether pre-loaded with the Machine, installed subsequently or otherwise. Unless IBM specifies otherwise, the following warranties apply only in the country where you acquire the Machine. Nothing in this Statement of Warranty affects any statutory rights of consumers that cannot be waived or limited by contract. If you have any questions, contact IBM or your reseller.

Machine - IBM Netfinity ServeRAID-3H or ServeRAID-3L Ultra2 SCSI Adapter

Warranty Period* - Three Years

**Contact your place of purchase for warranty service information. Some IBM Machines are eligible for On-site warranty service depending on the country where service is performed.*

The IBM Warranty for Machines

IBM warrants that each Machine 1) is free from defects in materials and workmanship and 2) conforms to IBM's Official Published Specifications. The warranty period for a Machine is a specified, fixed period commencing on its Date of Installation. The date on your sales receipt is the Date of Installation, unless IBM or your reseller informs you otherwise.

During the warranty period IBM or your reseller, if approved by IBM to provide warranty service, will provide repair and exchange service for the Machine, without charge, under the type of service designated for the Machine and will manage and install engineering changes that apply to the Machine.

If a Machine does not function as warranted during the warranty period, and IBM or your reseller are unable to either 1) make it do so or 2) replace it with one that is at least functionally equivalent, you may return it to your place of purchase and your money will be refunded. The replacement may not be new, but will be in good working order.

Extent of Warranty

The warranty does not cover the repair or exchange of a Machine resulting from misuse, accident, modification, unsuitable physical or operating environment, improper maintenance by you, or failure caused by a product for which IBM is not responsible. The warranty is voided by removal or alteration of Machine or parts identification labels.

THESE WARRANTIES ARE YOUR EXCLUSIVE WARRANTIES AND REPLACE ALL OTHER WARRANTIES OR CONDITIONS, EXPRESS OR IMPLIED, INCLUDING, BUT NOT LIMITED TO, THE IMPLIED WARRANTIES OR CONDITIONS OF MERCHANTABILITY AND FITNESS FOR A PARTICULAR PURPOSE. THESE WARRANTIES GIVE YOU SPECIFIC LEGAL RIGHTS AND YOU MAY ALSO HAVE OTHER RIGHTS WHICH VARY FROM JURISDICTION TO JURISDICTION. SOME JURISDICTIONS DO NOT ALLOW THE EXCLUSION OR LIMITATION OF EXPRESS OR IMPLIED WARRANTIES, SO THE ABOVE EXCLUSION OR LIMITATION MAY NOT APPLY TO YOU. IN THAT EVENT, SUCH WARRANTIES ARE LIMITED IN DURATION TO THE WARRANTY PERIOD. NO WARRANTIES APPLY AFTER THAT PERIOD.

Items Not Covered by Warranty

IBM does not warrant uninterrupted or error-free operation of a Machine.

Unless specified otherwise, IBM provides non-IBM machines **WITHOUT WARRANTIES OF ANY KIND.**

Any technical or other support provided for a Machine under warranty, such as assistance via telephone with "how-to" questions and those regarding Machine set-up and installation, will be provided **WITHOUT WARRANTIES OF ANY KIND.**

Warranty Service

To obtain warranty service for the Machine, contact your reseller or IBM. In the United States, call IBM at 1-800-772-2227. In Canada, call IBM at 1-800-565-3344. You may be required to present proof of purchase.

IBM or your reseller provides certain types of repair and exchange service, either at your location or at a service center, to keep Machines in, or restore them to, conformance with their Specifications. IBM or your reseller will inform you of the available types of service for a Machine based on its country of installation. IBM may repair the failing Machine or exchange it at its discretion.

When warranty service involves the exchange of a Machine or part, the item IBM or your reseller replaces becomes its property and the replacement becomes yours. You represent that all removed items are genuine and unaltered. The replacement may not be new, but will be in good working order and at least functionally equivalent to the item replaced. The replacement assumes the warranty service status of the replaced item.

Any feature, conversion, or upgrade IBM or your reseller services must be installed on a Machine which is 1) for certain Machines, the designated, serial-numbered Machine and 2) at an engineering-change level compatible with the feature, conversion, or upgrade. Many features, conversions, or upgrades involve the removal of parts and their return to IBM. A part that replaces a removed part will assume the warranty service status of the removed part.

Before IBM or your reseller exchanges a Machine or part, you agree to remove all features, parts, options, alterations, and attachments not under warranty service.

You also agree to

1. ensure that the Machine is free of any legal obligations or restrictions that prevent its exchange;
2. obtain authorization from the owner to have IBM or your reseller service a Machine that you do not own; and
3. where applicable, before service is provided
 - a. follow the problem determination, problem analysis, and service request procedures that IBM or your reseller provides,
 - b. secure all programs, data, and funds contained in a Machine,
 - c. provide IBM or your reseller with sufficient, free, and safe access to your facilities to permit them to fulfill their obligations, and
 - d. inform IBM or your reseller of changes in a Machine's location.

IBM is responsible for loss of, or damage to, your Machine while it is 1) in IBM's possession or 2) in transit in those cases where IBM is responsible for the transportation charges.

Neither IBM nor your reseller is responsible for any of your confidential, proprietary or personal information contained in a Machine which you return to IBM or your reseller for any reason. You should remove all such information from the Machine prior to its return.

Production Status

Each IBM Machine is manufactured from new parts, or new and used parts. In some cases, the Machine may not be new and may have been previously installed. Regardless of the Machine's production status, IBM's appropriate warranty terms apply.

Limitation of Liability

Circumstances may arise where, because of a default on IBM's part or other liability, you are entitled to recover damages from IBM. In each such instance, regardless of the basis on which you are entitled to claim damages from IBM (including fundamental breach, negligence, misrepresentation, or other contract or tort claim), IBM is liable for no more than

1. damages for bodily injury (including death) and damage to real property and tangible personal property; and
2. the amount of any other actual direct damages, up to the greater of U.S. \$100,000 (or equivalent in local currency) or the charges (if recurring, 12 months' charges apply) for the Machine that is the subject of the claim.

This limit also applies to IBM's suppliers and your reseller. It is the maximum for which IBM, its suppliers, and your reseller are collectively responsible.

UNDER NO CIRCUMSTANCES IS IBM LIABLE FOR ANY OF THE FOLLOWING: 1) THIRD-PARTY CLAIMS AGAINST YOU FOR DAMAGES (OTHER THAN THOSE UNDER THE FIRST ITEM LISTED ABOVE); 2) LOSS OF, OR DAMAGE TO, YOUR RECORDS OR DATA; OR 3) SPECIAL, INCIDENTAL, OR INDIRECT DAMAGES OR FOR ANY ECONOMIC CONSEQUENTIAL DAMAGES (INCLUDING LOST PROFITS OR SAVINGS), EVEN IF IBM, ITS SUPPLIERS OR YOUR RESELLER IS INFORMED OF THEIR POSSIBILITY. SOME JURISDICTIONS DO NOT ALLOW THE EXCLUSION OR LIMITATION OF INCIDENTAL OR CONSEQUENTIAL DAMAGES, SO THE ABOVE LIMITATION OR EXCLUSION MAY NOT APPLY TO YOU.

IBM Statement of Warranty Worldwide except Canada, Puerto Rico, Turkey, United States (Part 1 - General Terms)

This Statement of Warranty includes Part 1 - General Terms and Part 2 - Country-unique Terms. The terms of Part 2 may replace or modify those of Part 1. The warranties provided by IBM in this Statement of Warranty apply only to Machines you purchase for your use, and not for resale, from IBM or your reseller. The term "Machine" means an IBM machine, its features, conversions, upgrades, elements, or accessories, or any combination of them. The term "Machine" does not include any software programs, whether pre-loaded with the Machine, installed subsequently or otherwise. Unless IBM specifies otherwise, the following warranties apply only in the country where you acquire the Machine. Nothing in this Statement of Warranty affects any statutory rights of consumers that cannot be waived or limited by contract. If you have any questions, contact IBM or your reseller.

Machine - IBM Netfinity ServeRAID-3H or ServeRAID-3L Ultra2 SCSI Adapter

Warranty Period* - Three Years

**Contact your place of purchase for warranty service information. Some IBM Machines are eligible for On-site warranty service depending on the country where service is performed.*

The IBM Warranty for Machines

IBM warrants that each Machine 1) is free from defects in materials and workmanship and 2) conforms to IBM's Official Published Specifications. The warranty period for a Machine is a specified, fixed period commencing on its Date of Installation. The date on your sales receipt is the Date of Installation, unless IBM or your reseller informs you otherwise.

During the warranty period IBM or your reseller, if approved by IBM to provide warranty service, will provide repair and exchange service for the Machine, without charge, under the type of service designated for the Machine and will manage and install engineering changes that apply to the Machine.

If a Machine does not function as warranted during the warranty period, and IBM or your reseller are unable to either 1) make it do so or 2) replace it with one that is at least functionally equivalent, you may return it to your place of purchase and your money will be refunded. The replacement may not be new, but will be in good working order.

Extent of Warranty

The warranty does not cover the repair or exchange of a Machine resulting from misuse, accident, modification, unsuitable physical or operating environment, improper

maintenance by you, or failure caused by a product for which IBM is not responsible. The warranty is voided by removal or alteration of Machine or parts identification labels.

THESE WARRANTIES ARE YOUR EXCLUSIVE WARRANTIES AND REPLACE ALL OTHER WARRANTIES OR CONDITIONS, EXPRESS OR IMPLIED, INCLUDING, BUT NOT LIMITED TO, THE IMPLIED WARRANTIES OR CONDITIONS OF MERCHANTABILITY AND FITNESS FOR A PARTICULAR PURPOSE. THESE WARRANTIES GIVE YOU SPECIFIC LEGAL RIGHTS AND YOU MAY ALSO HAVE OTHER RIGHTS WHICH VARY FROM JURISDICTION TO JURISDICTION. SOME JURISDICTIONS DO NOT ALLOW THE EXCLUSION OR LIMITATION OF EXPRESS OR IMPLIED WARRANTIES, SO THE ABOVE EXCLUSION OR LIMITATION MAY NOT APPLY TO YOU. IN THAT EVENT, SUCH WARRANTIES ARE LIMITED IN DURATION TO THE WARRANTY PERIOD. NO WARRANTIES APPLY AFTER THAT PERIOD.

Items Not Covered by Warranty

IBM does not warrant uninterrupted or error-free operation of a Machine.

Unless specified otherwise, IBM provides non-IBM machines **WITHOUT WARRANTIES OF ANY KIND.**

Any technical or other support provided for a Machine under warranty, such as assistance via telephone with "how-to" questions and those regarding Machine set-up and installation, will be provided **WITHOUT WARRANTIES OF ANY KIND.**

Warranty Service

To obtain warranty service for the Machine, contact your reseller or IBM. You may be required to present proof of purchase.

IBM or your reseller provides certain types of repair and exchange service, either at your location or at a service centre, to keep Machines in, or restore them to, conformance with their Specifications. IBM or your reseller will inform you of the available types of service for a Machine based on its country of installation. IBM may repair the failing Machine or exchange it at its discretion.

When warranty service involves the exchange of a Machine or part, the item IBM or your reseller replaces becomes its property and the replacement becomes yours. You represent that all removed items are genuine and unaltered. The replacement may not be new, but will be in good working order and at least functionally equivalent to the item replaced. The replacement assumes the warranty service status of the replaced item.

Any feature, conversion, or upgrade IBM or your reseller services must be installed on a Machine which is 1) for certain Machines, the designated, serial-numbered Machine and 2) at an engineering-change level compatible with the feature, conversion, or upgrade. Many features, conversions, or upgrades involve the removal of parts and

their return to IBM. A part that replaces a removed part will assume the warranty service status of the removed part.

Before IBM or your reseller exchanges a Machine or part, you agree to remove all features, parts, options, alterations, and attachments not under warranty service.

You also agree to

1. ensure that the Machine is free of any legal obligations or restrictions that prevent its exchange;
2. obtain authorisation from the owner to have IBM or your reseller service a Machine that you do not own; and
3. where applicable, before service is provided
 - a. follow the problem determination, problem analysis, and service request procedures that IBM or your reseller provides,
 - b. secure all programs, data, and funds contained in a Machine,
 - c. provide IBM or your reseller with sufficient, free, and safe access to your facilities to permit them to fulfil their obligations, and
 - d. inform IBM or your reseller of changes in a Machine's location.

IBM is responsible for loss of, or damage to, your Machine while it is 1) in IBM's possession or 2) in transit in those cases where IBM is responsible for the transportation charges.

Neither IBM nor your reseller is responsible for any of your confidential, proprietary or personal information contained in a Machine which you return to IBM or your reseller for any reason. You should remove all such information from the Machine prior to its return.

Production Status

Each IBM Machine is manufactured from new parts, or new and used parts. In some cases, the Machine may not be new and may have been previously installed. Regardless of the Machine's production status, IBM's appropriate warranty terms apply.

Limitation of Liability

Circumstances may arise where, because of a default on IBM's part or other liability, you are entitled to recover damages from IBM. In each such instance, regardless of the basis on which you are entitled to claim damages from IBM (including fundamental breach, negligence, misrepresentation, or other contract or tort claim), IBM is liable for no more than

1. damages for bodily injury (including death) and damage to real property and tangible personal property; and
2. the amount of any other actual direct damages, up to the greater of U.S. \$100,000 (or equivalent in local currency) or the charges (if recurring, 12 months' charges apply) for the Machine that is the subject of the claim.

This limit also applies to IBM's suppliers and your reseller. It is the maximum for which IBM, its suppliers, and your reseller are collectively responsible.

UNDER NO CIRCUMSTANCES IS IBM LIABLE FOR ANY OF THE FOLLOWING: 1) THIRD-PARTY CLAIMS AGAINST YOU FOR DAMAGES (OTHER THAN THOSE UNDER THE FIRST ITEM LISTED ABOVE); 2) LOSS OF, OR DAMAGE TO, YOUR RECORDS OR DATA; OR 3) SPECIAL, INCIDENTAL, OR INDIRECT DAMAGES OR FOR ANY ECONOMIC CONSEQUENTIAL DAMAGES (INCLUDING LOST PROFITS OR SAVINGS), EVEN IF IBM, ITS SUPPLIERS OR YOUR RESELLER IS INFORMED OF THEIR POSSIBILITY. SOME JURISDICTIONS DO NOT ALLOW THE EXCLUSION OR LIMITATION OF INCIDENTAL OR CONSEQUENTIAL DAMAGES, SO THE ABOVE LIMITATION OR EXCLUSION MAY NOT APPLY TO YOU.

Part 2 - Worldwide Country-Unique Terms

ASIA PACIFIC

AUSTRALIA: The IBM Warranty for Machines: The following paragraph is added to this Section:

The warranties specified in this Section are in addition to any rights you may have under the Trade Practices Act 1974 or other legislation and are only limited to the extent permitted by the applicable legislation.

Extent of Warranty: The following replaces the first and second sentences of this Section:

The warranty does not cover the repair or exchange of a Machine resulting from misuse, accident, modification, unsuitable physical or operating environment, operation in other than the Specified Operating Environment, improper maintenance by you, or failure caused by a product for which IBM is not responsible.

Limitation of Liability: The following is added to this Section:

Where IBM is in breach of a condition or warranty implied by the Trade Practices Act 1974, IBM's liability is limited to the repair or replacement of the goods or the supply of equivalent goods. Where that condition or warranty relates to right to sell, quiet possession or clear title, or the goods are of a kind ordinarily acquired for personal, domestic or household use or consumption, then none of the limitations in this paragraph apply.

PEOPLE'S REPUBLIC OF CHINA: Governing Law: The following is added to this Statement:

The laws of the State of New York govern this Statement.

INDIA: Limitation of Liability: The following replaces items 1 and 2 of this Section:

1. liability for bodily injury (including death) or damage to real property and tangible personal property will be limited to that caused by IBM's negligence;
2. as to any other actual damage arising in any situation involving nonperformance by IBM pursuant to, or in any way related to the subject of this Statement of Warranty,

IBM's liability will be limited to the charge paid by you for the individual Machine that is the subject of the claim.

NEW ZEALAND: The IBM Warranty for Machines: The following paragraph is added to this Section:

The warranties specified in this Section are in addition to any rights you may have under the Consumer Guarantees Act 1993 or other legislation which cannot be excluded or limited. The Consumer Guarantees Act 1993 will not apply in respect of any goods which IBM provides, if you require the goods for the purposes of a business as defined in that Act.

Limitation of Liability: The following is added to this Section:

Where Machines are not acquired for the purposes of a business as defined in the Consumer Guarantees Act 1993, the limitations in this Section are subject to the limitations in that Act.

EUROPE, MIDDLE EAST, AFRICA (EMEA)

The following terms apply to all EMEA countries.

The terms of this Statement of Warranty apply to Machines purchased from an IBM reseller. If you purchased this Machine from IBM, the terms and conditions of the applicable IBM agreement prevail over this warranty statement.

Warranty Service

If you purchased an IBM Machine in Austria, Belgium, Denmark, Estonia, Finland, France, Germany, Greece, Iceland, Ireland, Italy, Latvia, Lithuania, Luxembourg, Netherlands, Norway, Portugal, Spain, Sweden, Switzerland or United Kingdom, you may obtain warranty service for that Machine in any of those countries from either (1) an IBM reseller approved to perform warranty service or (2) from IBM.

If you purchased an IBM Personal Computer Machine in Albania, Armenia, Belarus, Bosnia and Herzegovina, Bulgaria, Croatia, Czech Republic, Georgia, Hungary, Kazakhstan, Kirghizia, Federal Republic of Yugoslavia, Former Yugoslav Republic of Macedonia (FYROM), Moldova, Poland, Romania, Russia, Slovak Republic, Slovenia, or Ukraine, you may obtain warranty service for that Machine in any of those countries from either (1) an IBM reseller approved to perform warranty service or (2) from IBM.

The applicable laws, Country-unique terms and competent court for this Statement are those of the country in which the warranty service is being provided. However, the laws of Austria govern this Statement if the warranty service is provided in Albania, Armenia, Belarus, Bosnia and Herzegovina, Bulgaria, Croatia, Czech Republic, Federal Republic of Yugoslavia, Georgia, Hungary, Kazakhstan, Kirghizia, Former Yugoslav Republic of Macedonia (FYROM), Moldova, Poland, Romania, Russia, Slovak Republic, Slovenia, and Ukraine.

The following terms apply to the country specified:

EGYPT: Limitation of Liability: The following replaces item 2 in this Section:

2. as to any other actual direct damages, IBM's liability will be limited to the total amount you paid for the Machine that is the subject of the claim.

Applicability of suppliers and resellers (unchanged).

FRANCE: Limitation of Liability: The following replaces the second sentence of the first paragraph of this Section:

In such instances, regardless of the basis on which you are entitled to claim damages from IBM, IBM is liable for no more than: (items 1 and 2 unchanged).

GERMANY: The IBM Warranty for Machines: The following replaces the first sentence of the first paragraph of this Section:

The warranty for an IBM Machine covers the functionality of the Machine for its normal use and the Machine's conformity to its Specifications.

The following paragraphs are added to this Section:

The minimum warranty period for Machines is six months.

In case IBM or your reseller are unable to repair an IBM Machine, you can alternatively ask for a partial refund as far as justified by the reduced value of the unrepaired Machine or ask for a cancellation of the respective agreement for such Machine and get your money refunded.

Extent of Warranty: The second paragraph does not apply.

Warranty Service: The following is added to this Section:

During the warranty period, transportation for delivery of the failing Machine to IBM will be at IBM's expense.

Production Status: The following paragraph replaces this Section:

Each Machine is newly manufactured. It may incorporate in addition to new parts, re-used parts as well.

Limitation of Liability: The following is added to this Section:

The limitations and exclusions specified in the Statement of Warranty will not apply to damages caused by IBM with fraud or gross negligence and for express warranty.

In item 2, replace "U.S. \$100,000" with "1.000.000 DEM."

The following sentence is added to the end of the first paragraph of item 2:

IBM's liability under this item is limited to the violation of essential contractual terms in cases of ordinary negligence.

IRELAND: Extent of Warranty: The following is added to this Section:

Except as expressly provided in these terms and conditions, all statutory conditions, including all warranties implied, but without prejudice to the generality of the foregoing all warranties implied by the Sale of Goods Act 1893 or the Sale of Goods and Supply of Services Act 1980 are hereby excluded.

Limitation of Liability: The following replaces items one and two of the first paragraph of this Section:

1. death or personal injury or physical damage to your real property solely caused by IBM's negligence; and 2. the amount of any other actual direct damages, up to the greater of Irish Pounds 75,000 or 125 percent of the charges (if recurring, the 12

months' charges apply) for the Machine that is the subject of the claim or which otherwise gives rise to the claim.

Applicability of suppliers and resellers (unchanged).

The following paragraph is added at the end of this Section:
IBM's entire liability and your sole remedy, whether in contract or in tort, in respect of any default shall be limited to damages.

ITALY: Limitation of Liability: The following replaces the second sentence in the first paragraph:

In each such instance unless otherwise provided by mandatory law, IBM is liable for no more than: (item 1 unchanged) 2) as to any other actual damage arising in all situations involving non-performance by IBM pursuant to, or in any way related to the subject matter of this Statement of Warranty, IBM's liability, will be limited to the total amount you paid for the Machine that is the subject of the claim.

Applicability of suppliers and resellers (unchanged).

The following replaces the second paragraph of this Section:
Unless otherwise provided by mandatory law, IBM and your reseller are not liable for any of the following: (items 1 and 2 unchanged) 3) indirect damages, even if IBM or your reseller is informed of their possibility.

SOUTH AFRICA, NAMIBIA, BOTSWANA, LESOTHO AND SWAZILAND: Limitation of Liability: The following is added to this Section:

IBM's entire liability to you for actual damages arising in all situations involving nonperformance by IBM in respect of the subject matter of this Statement of Warranty will be limited to the charge paid by you for the individual Machine that is the subject of your claim from IBM.

TURKIYE: Production Status: The following replaces this Section:
IBM fulfils customer orders for IBM Machines as newly manufactured in accordance with IBM's production standards.

UNITED KINGDOM: Limitation of Liability: The following replaces items 1 and 2 of the first paragraph of this Section:

1. death or personal injury or physical damage to your real property solely caused by IBM's negligence;
2. the amount of any other actual direct damages or loss, up to the greater of Pounds Sterling 150,000 or 125 percent of the charges (if recurring, the 12 months' charges apply) for the Machine that is the subject of the claim or which otherwise gives rise to the claim.

The following item is added to this paragraph:
3. breach of IBM's obligations implied by Section 12 of the Sale of Goods Act 1979 or Section 2 of the Supply of Goods and Services Act 1982.

Applicability of suppliers and resellers (unchanged).

The following is added to the end of this Section:

IBM's entire liability and your sole remedy, whether in contract or in tort, in respect of any default will be limited to damages.

NORTH AMERICA

CANADA: Warranty Service: The following is added to this Section:
To obtain warranty service from IBM, call **1-800-465-6666**.

UNITED STATES OF AMERICA: Warranty Service: The following is added to this Section:
To obtain warranty service from IBM, call **1-800-IBM-SERV**.

Notices

References in this publication to IBM products, programs, or services do not imply that IBM intends to make these available in all countries in which IBM operates. Any reference to an IBM product, program, or service is not intended to state or imply that only that IBM product, program, or service may be used. Subject to IBM's valid intellectual property or other legally protectable rights, any functionally equivalent product, program, or service may be used instead of the IBM product, program, or service. The evaluation and verification of operation in conjunction with other products, except those expressly designated by IBM, are the responsibility of the user.

IBM may have patents or pending patent applications covering subject matter in this document. The furnishing of this document does not give you any license to these patents. You can send license inquiries, in writing, to:

IBM Director of Licensing
IBM Corporation
North Castle Drive
Armonk, NY 10504-1785
U.S.A.

Year 2000 Readiness and Instructions

A product is Year 2000 Ready if the product, when used in accordance with its associated documentation, is capable of correctly processing, providing and/or receiving date data within and between the 20th and 21st centuries, provided all other products (for example, software, hardware, and firmware) used with the product properly exchange date data with it.

This IBM PC hardware product has been designed to process four-digit date information correctly within and between the 20th and 21st centuries. If your IBM computer is on when the century changes, you should turn it off and then back on again once, or restart the operating system, to ensure that the internal clock resets itself for the new century.

This IBM PC product cannot prevent errors that might occur if software you use or exchange data with is not ready for the Year 2000. IBM software that comes with this product is Year 2000 Ready. However, software from other companies might come with this IBM PC product. IBM cannot take responsibility for the readiness of that software. You should contact the software developers directly if you wish to verify readiness, understand limitations, or look for any software updates.

To learn more about IBM PC products and the Year 2000, visit our Web site at <http://www.pc.ibm.com/year2000>. The information and tools there can help you with your Year 2000 transition plan, especially if you have multiple IBM PCs. IBM encourages you to check periodically for updated information.

Trademarks

The following terms are trademarks of the IBM Corporation in the United States or other countries:

IBM	Netfinity
OS/2	ServeRAID
HelpCenter	IntelliStation
HelpWare	Netfinity Manager
ThinkPad	Predictive Failure Analysis

UNIX is a registered trademark in the United States and other countries licensed exclusively through X/Open Company Limited.

Microsoft, Windows, and Windows NT are trademarks or registered trademarks of Microsoft Corporation.

Other company, product, and service names may be trademarks or service marks of others.

Federal Communications Commission (FCC) Statement

Note: This equipment has been tested and found to comply with the limits for a Class A digital device, pursuant to Part 15 of the FCC Rules. These limits are designed to provide reasonable protection against harmful interference when the equipment is operated in a commercial environment. This equipment generates, uses, and can radiate radio frequency energy and, if not installed and used in accordance with the instruction manual, may cause harmful interference to radio communications. Operation of this equipment in a residential area is likely to cause harmful interference, in which case the user will be required to correct the interference at his own expense.

Properly shielded and grounded cables and connectors must be used in order to meet FCC emission limits. IBM is not responsible for any radio or television interference caused by using other than recommended cables and connectors or by unauthorized changes or modifications to this equipment. Unauthorized changes or modifications could void the user's authority to operate the equipment.

This device complies with Part 15 of the FCC Rules. Operation is subject to the following two conditions: (1) this device may not cause harmful interference, and (2) this device must accept any interference received, including interference that may cause undesired operation.

United Kingdom Telecommunications Safety Requirements

Notice to Customers

This apparatus is approved under approval number NS/G/1234/J/100003 for indirect connection to public telecommunication systems in the United Kingdom.

European Community Directive Conformance Statement

This product is in conformity with the protection requirements of EC Council Directive 89/336/EEC on the approximation of the laws of the Member States relating to electro-magnetic compatibility.

A declaration of Conformity with the requirements of the Directive has been signed by IBM Corporation, 3039 Cornwallis Road, Research Triangle Park, North Carolina, 27709.

Attention: This is a Class A product. In a domestic environment this product may cause radio interference in which case the user may be required to take adequate measures.

Industry Canada Class A Emission Compliance Statement

This Class A digital apparatus complies with Canadian ICES-003.

Avis de conformité à la réglementation d'Industrie Canada

Cet appareil numérique de la classe A est conforme à la norme NMB-003 du Canada.

Australia and New Zealand Class A Statement

Attention: This is a Class A product. In a domestic environment this product may cause radio interference in which case the user may be required to take adequate measures.

Taiwanese Electromagnetic Interference (EMI) Statement

警告使用者：
這是甲類的資訊產品，在居住的環境中使用時，可能
會造成射頻干擾，在這種情形下，使用者會被要求採取某些適當的對策。

Index

Numerics

1-800 telephone assistance 165
900 number support 167

A

about this book v
accelerator, array 12
Actions pull-down
 array choices 46
 configure the controller
 choices 44
 hot-spare drive choices 49
 logical drive choices 47
 physical drive choices 49
 using 44
adapter
 cabling 11
 configure, icon 41
 copying drive configuration 118,
 119
 features 12
 initializing 120
 installation overview 3
 installing 11, 15
 monitoring event logs 123
 settings, changing 40
 status information,
 monitoring 121
adding
 physical drives 114
 scan for drives 42, 46, 50
administration, ServeRAID
 program 61
advanced functions
 mini-configuration 51
 using 53

advanced setting, options 43
alarm 102, 103
alert options 100, 103
allotting data and parity space 29
array
 accelerator 12
 administration 105
 configuring 24
 create, icon 42
 creating 46
 deleting 46
 description 5
 expanding 114
 hard disk drive capacities 28
 information panel 33
 information, viewing 33
 maximum supported 12
 number of, viewing 33
assistance 161
auto-synchronization 32, 43, 48,
110

B

background-server component
 description 62
 installing 63, 65
 name resolution 92
 OpenServer 63
 OS/2 62
 starting 88
 UnixWare 63
 using 89
 Windows 61
BACKUP command 127
bad stripes 53

- basic setting, options 43
- battery backup cache 12, 14, 32, 34, 47, 52
- BCS codes 151
- BIOS version 31
- blocked logical drive 37, 111, 150, 159
- boot drive 27, 29, 30
- bootable CD-ROM feature 17, 52, 55
- bulletin boards 162
- button
 - cancel 23, 41
 - modify 26

C

- cable
 - adapter, connecting 12
 - Channel 3, option 2
 - connecting, DASD status 16
 - DASD status 2
 - external, Channel 3 option 14
 - installing, DASD status 16
- cache
 - battery backup 12, 14, 32, 34, 52
 - memory, standard 12
 - read-ahead mode 32, 45, 52
 - write-back mode 47
 - write-cache mode 34
 - write-cache mode, changing 47
 - write-through mode 47
- cancel button 23, 41
- CD-ROM
 - configuration program, starting 22
 - contents 60, 63
 - obtaining replacement CDs 59
 - ServeRAID Configuration Program 2
- CERTIFY command 133
- changing
 - bootable CD settings 55
 - RAID levels 112
 - SCSI transfer speed 49
 - settings 40
 - stripe-unit size 46
 - write-cache mode 47
- channel
 - cable option, Channel 3 2, 14
 - information panel 36
 - SCSI connectors 12, 13
 - viewing information 36
- clearing configuration-event log 21, 41, 42
- client/server mode, setting 100
- cluster partner Host ID 32
- clustering 32, 41, 44, 52
- codes, configuration status 151, 153
- command-line parameters, using 90, 139
- compatibility mode, BIOS 52
- component, background-server 62
- configuration
 - alert options 103
 - BCS codes 153
 - BIOS settings 54
 - CD, ServeRAID 2, 59
 - clearing, event log 42
 - clustering 44
 - codes, configuration status 153
 - copy from drive to controller 45
 - custom path 24, 27, 28
 - drag and drop icons 29
 - ECS codes 153
 - event log 21, 41, 42
 - express path 24, 25, 26
 - for clustering, icon 41
 - icons, drag and drop 29

- configuration (*continued*)
 - information mode 30
 - information, viewing 31
 - initialize 44, 54
 - Netfinity alert options 103
 - paths 24
 - program screens 20
 - program, exiting 42
 - program, starting 22
 - quick path, express 25
 - saving, event log 42
 - ServeRAID CD 57
 - ServeRAID controller 41, 44
 - status codes 153
 - summary screen 30
 - viewing 51
- configuring disk arrays 24, 46, 105
- connecting
 - adapter 11
 - cables 11, 12, 16
 - DASD status cable 16
 - external devices 18
- connector
 - DASD status 13
 - locations 12, 13, 14
 - SCSI channel 12, 13
- contents, option package 2
- context-sensitive help 42
- controller information panel 31
- controller type 31
- copy configuration from drives to controller 45
- copying adapter configuration to drives 119
- copying drive configuration to adapter 118
- COPYLD command 128
- creating
 - array 24, 46
 - array icon 42

- creating (*continued*)
 - disk arrays 24, 46, 105
 - logical drive 47, 108
- creation date, logical drive 34
- critical states 37, 117, 118
- custom configuration path
 - considerations 27
 - learning about 27
 - using 28

D

- damaged items 2
- DASD status cable 2, 13, 16
- data bus, system PCI 12
- data scrubbing 32
- data space 29, 34, 107
- data striping 5
- date created 34
- defining
 - logical drive 29, 47
- defunct state 39
- deleting
 - arrays 29, 46, 107
 - hot-spare drives 29
- description
 - array 5
 - background-server component 62
 - battery backup cache 14
 - configuration paths 24
 - configuration program, screen layout 20
 - custom configuration 27
 - express configuration 25
 - features, adapter 12
 - hot-swap PCI 15
 - information mode 30
 - IPSEND and IPSMON 92
 - logical drive 5
 - logical drive states 37

- description (*continued*)
 - menu bar 42
 - option package 2
 - package contents 2
 - physical drive states 38
 - RAID levels 6
 - RAID technology 5
 - stripe-unit size 5, 46
 - tool bar icons 41
 - WIN32-Based program 61
 - write-cache modes 47
- device driver
 - installing 4, 57, 65
 - NetWare 3.12, installing 69, 70
 - NetWare 4.1X, installing 71, 72
 - OpenServer, installing 78, 81
 - OS/2, installing 74, 76
 - UnixWare, installing 82, 87
 - Windows NT, installing 63, 66
- device event log 123, 142
- disable read-ahead cache 45
- disabling the alarm 102
- disk array
 - creating 24, 105
 - deleting 29, 46, 107
 - increasing free space 114
- disk mirroring 8
- diskette
 - IBM ServeRAID Device Driver Diskette 2, 60
 - IBM ServeRAID Device Drivers for SCO Operating Systems Diskette 2, 60
 - images 63
- drive capacities, hard disk 28
- drive states 37
- drive type 35
- DRIVEVER command 137

E

- ECS codes 151
- electronic support 162
- empty state 39
- enable read-ahead cache 45
- enabling the alarm 102
- enhanced RAID level-1 9
- ERASEEVENT command 133
- error messages
 - basic configuration status register codes 151, 153
 - disk array 142
 - extended status register codes 151, 153
 - interrupt status port register codes 151, 152
 - PFA 35, 36
 - POST messages 142, 150, 151
 - ServeRAID 142
 - startup messages 142, 150, 151, 152, 153
- event log
 - clearing or saving 41
 - configuration, clearing or saving 21, 42
 - device 123
- event viewer 21
- example
 - enhanced RAID level-1 9
 - express configuration 25
 - RAID level-0 7
 - RAID level-1 8
 - RAID level-5 10
 - screen, configuration program 20
 - stripe-unit size 6
- exiting the configuration program 42
- expanding the array 114

express configuration path
 learning about 25
 using 24, 26
external devices, connecting 18
external SCSI channel 12, 13

F

fax, getting information by 164
features
 adapter 12
 Channel 3 cable option 14
 hot-swap rebuild 32, 159
 RAID levels 5
 ServeRAID adapters 12
fee services 167
File pull-down menu 42
firmware version 31
FMSTATUS command 134
forced synchronization 43
FORMAT command 134
free space 33

G

general information, rebuilding 160
general options 100, 102
GETCONFIG command 137
GETEVENT command 135
GETSTATUS command 130

H

hard disk
 capacities, influence on
 arrays 28
 copying adapter
 configuration 119
 copying configuration to
 adapter 118
 hot-spare 28

hard disk (*continued*)
 maximum supported 12
 scanning for 42, 46, 50, 121
 status 38
hard event, logged 123
help, getting 161
help, online 21, 42, 50
home page, IBM Personal
 Computing 161, 163
Host ID 32
hot-spare drive 28
 description 28
 information panel 34
 maximum supported 12
 number of, viewing 33
 removing 29
 standby 40
 state 39
 viewing, information 34
hot-swap PCI 15, 22
hot-swap rebuild 32, 122, 138, 159
how this book is organized v
HSREBUILD command 138

I

icons
 changing size, View
 pull-down 43
 configure for clustering 41
 configure the ServeRAID
 controller 41
 create an array 42
 drag and drop 29
 event viewer 21
 help 42
 save the configuration event
 log 41
 scan for drives 42
 tool bar 21, 41

- ID, Host 32
- illustration
 - enhanced RAID level-1 9
 - RAID level-0 7
 - RAID level-1 8
 - RAID level-5 10
 - screen, configuration program 20
- import configuration 54
- improve system performance 5
- increasing free space in disk array 114
- increasing size of all logical drives 114
- information mode, description 30
- information panel
 - array 33
 - channel 36
 - controller 31
 - hot-spare drive 34
 - logical drive 33
 - physical drive 35
 - system 31
- INIT command 129
- initialize
 - automatic 43
 - controller configuration 44, 54
 - disabling 43
 - logical drive 110
 - ServeRAID adapter 120
- initiator ID, SCSI 36
- INITSYNC command 129
- installation overview 3
- installing
 - adapter 15
 - additional drives 114
 - administration and monitoring program 57, 63
 - device driver, NetWare 3.12 69
 - device drivers 4, 57, 65
- installing (*continued*)
 - device drivers, NetWare 69
 - device drivers, NetWare 3.12 70
 - device drivers, Windows NT 66
 - IPSSSEND and IPSMON 92, 93
 - IPSSSEND, for DOS 96
 - NetWare 4.1X, device driver 71, 72
 - OpenServer device drivers 78, 81
 - operating system 4
 - OS/2 device driver 74, 76
 - ServeRAID adapter 11
 - ServeRAID adapter, overview 3
 - UnixWare device driver 82, 87
 - WIN32-Based program 63, 64
 - Windows NT, files for 65
- interleave depth/stripe unit 5
- internal SCSI channel 12, 13
- international warranty service 167
- Internet home page 161, 163
- introduction 1
- IPSMON program
 - installing 92
 - obtaining 59
 - parameters 139
 - starting 138
 - using 139
- ipsr codes 151
- IPSSSEND program
 - commands 127, 138
 - installing 92
 - obtaining 59
 - starting 126
 - using 127
- items, missing or damaged 2

L

- large icons 43

- LDM (logical drive migration) 37, 110, 112
- LEDs 12
- levels, logical drive
 - affects on the rebuild operation 159
 - changing 38, 110, 112
 - enhanced level-1 9
 - level-0 6, 38, 106, 109
 - level-1 8, 37, 38, 106, 109
 - level-5 10, 37, 38, 107, 109
 - migrating 38
- light-emitting diodes 12
- logging messages 91
- logical drive
 - administration 105, 108
 - blocked 37, 53
 - boot, first defined 27, 29, 30
 - creating 29, 30, 108
 - creation date 34
 - critical states 37
 - date created 34
 - defining 29, 30, 108
 - description 5
 - guidelines for rebuilding 159
 - increasing its size 114
 - information panel 33
 - information, monitoring 124
 - initializing 48, 110
 - maximum supported 12
 - migrating state 38
 - migration 112
 - number of, viewing 33
 - slots available 44
 - states 34, 37
 - synchronizing 48, 110
 - system state 38
 - unblocking 37, 48, 53, 111
 - with bad stripes 53

M

- Main Menu
 - Administration and Monitoring Program 98
 - Configuration Program 21
 - Mini-Configuration program 51
- main panel 21
- main tree 21
- maximum
 - arrays supported 12
 - disk drives supported 12
 - hot-spare drives 12
 - logical drives supported 12
- memory, cache 12
- menu bar 21, 42
- merge-group 34
- messages
 - basic configuration status register
 - codes 151, 153
 - extended status register
 - codes 151, 153
 - interrupt status port register
 - codes 151, 152
 - logging 91
 - numeric 150
 - ServeRAID 142
 - text, startup 142
- microprocessor, onboard 12
- migrating state 38
- migrating, logical drives 112
- mini-configuration menu
 - importing configuration from drives 53
 - initializing configuration 53
 - resetting ServeRAID adapter 53
 - viewing status 52
 - viewing the configuration 53
- mirroring, disk 8
- missing items 2

- mode
 - configuration 22, 24
 - custom configuration 27
 - express configuration 24
 - information 22, 30
 - switching 23, 24
- modify button 26
- monitoring
 - adapter status information 121
 - device event logs 123
 - logical drive information 124
 - physical device information 125
 - program, using 97
 - programs, installing 63

N

- name resolution, background-server component 92
- name, system 31
- Netfinity alert options 103
- NetWare
 - 3.12 device drivers, installing 69, 70
 - 4.1X device drivers, installing 71, 72
 - device drivers 60, 69
 - programs for 62
 - ServeRAID diskette, device drivers 2
- network and server startup support 165
- network and server support services, fee 168
- network operating system installing 4
- network settings 100
- notices viii, 183
- numeric messages 150

O

- obtaining updates 59
- offline state 38
- okay state 38
- onboard microprocessor 12
- Online Housecall 164
- online information services 162
- online state 39
- OpenServer
 - device drivers 60, 78, 81
 - programs for 63
 - ServeRAID diskette, device drivers 2
- option package contents 2
- Options pull-down menu 43, 100
- ordering support line services 168
- OS/2
 - administration and monitoring, starting 77
 - device drivers 60, 74, 76
 - programs for 62
 - ServeRAID diskette, device drivers 2
- overview, installation 3

P

- package contents 2
- panel
 - array information 33
 - channel information 36
 - controller information 31
 - hot-spare drive information 34
 - logical drive information 33
 - physical drive information 35
 - system information 31
- parallel transfer 5
- parity event, logged 123
- parity space 29, 34, 107

- paths, express and custom 24
- PCI, data bus 12
- PFA error 35, 36, 102
- physical drives
 - adding 114
 - defunct 39
 - empty 39
 - hot spare 39
 - information panel 35
 - information, monitoring 125
 - maximum supported 12
 - number of, viewing 33
 - online 39
 - ready 39
 - rebuilding 117
 - scanning for 42, 46, 50, 121
 - setting states 116
 - standby 39
 - standby hot spare 40
 - states 38
 - viewing information 35
- polling options 102, 103
- POST messages 142, 150
- preface v
- problems, solving 141
- product or model number, drive 35, 36
- product warranties 171
- program
 - Administration and Monitoring 61
 - configuration, starting 22
 - configuration, using 24
 - exiting the configuration program 42
 - for OpenServer and UnixWare 63
 - for OS/2 and Netware 62
 - for Windows 61
 - installing, administration and monitoring 63

- program (*continued*)
 - IPSEND and IPSMON, installing 92
 - mini-configuration 51
 - OS/2 administration and monitoring, starting 77
 - ServeRAID programs, installing 57
 - WIN32-Based, Administration and Monitoring 61
 - WIN32-Based, installing 64
- publications, ordering 170

Q

- quick path configuration 25

R

- RAID (redundant array of independent disks)
 - See also* ServeRAID adapter description 12
 - enhanced level-1 9
 - level-0 6, 38
 - level-1 8, 37, 38
 - level-5 10, 37, 38
 - level, changing 110, 112
 - supported levels 6
 - technology 5
 - viewing assigned levels 34
- rate, rebuild 32, 45, 52
- read-ahead cache 32, 45, 52
- ready state 39
- rebuild
 - automatically 160
 - general information 160
 - guidelines 159
 - logical drives 117, 159
 - state 39

- REBUILD command 130
- rebuild rate 32, 45, 52
- rebuilding a drive 159
- remote technical support 164
- removing a hot-spare drive 29
- replace and rebuild 49
- replacement CDs, obtaining 59
- resetting the alarm 103
- response time 5
- responses, simultaneous 5
- RESTORE command 128
- right mouse button, using 29, 40, 44
- roll-out commands, server 127

S

- sample
 - express configuration 25
 - screen, configuration program 20
 - stripe-unit size 6
- saving configuration-event log 21, 41, 42
- scanning for drives 42, 46, 50, 121
- SCO
 - ServeRAID diskette, device drivers 2
- screen, configuration program 20
- scrubbing, data 32
- SCSI transfer speed 12
- SELFTEST command 136
- send test alert 104
- serial number, drive 35, 36
- server roll-out commands 127
- server startup support 165
- ServeRAID adapter
 - configuration program, using 20, 22
 - configuring an array 24
 - features 12

- ServeRAID adapter (*continued*)
 - icon, configure 41
 - number of BIOS code updates 53
 - settings, changing 40
 - troubleshooting 142
 - using the mini-configuration program 51
- ServeRAID controller information, viewing 31
- services, fee 167
- SETSTATE command 131
- setting physical device states 116
- setting, Bootable CD-ROM 55
- simultaneous responses 5
- small icons 43
- soft event, logged 123
- solving problems 141, 162
- speed, SCSI transfer 12
- standby drive 39, 40
- STARTDELY command 136
- starting
 - administration and monitoring program 77, 97, 98
 - background-server component 88
 - configuration program 22
 - IPSMON program 138
 - IPSEND program 126
 - Mini-Configuration 51
- startup messages 142, 150
- state, drive
 - blocked 37
 - changing 116
 - critical 37
 - definitions 38
 - defunct 39
 - empty 39
 - hot spare 39
 - logical 34, 37

- state, drive (*continued*)
 - migrating 38
 - offline 38
 - okay 38
 - online 39
 - physical drives 38
 - ready 39
 - setting 116
 - standby 39
 - standby hot spare 40
 - system 38
- stripe-unit size 4, 5, 28, 32, 46
- striping, data 5, 6
- support line services, ordering 168
- supported
 - arrays, maximum 12
 - disk drives, maximum 12
 - logical drives, maximum 12
 - RAID levels 5
- switching modes 23, 24
- SYNCH command 130
- synchronizing
 - automatic 32
 - data scrubbing 32
 - forced 43
 - logical drives 110
 - manually 48
- system information panel 31
- system name 31
- system PCI data bus 12
- system performance, improve 5
- system state 38

T

- TCP/IP 62
- technical support, fee 167
- technical support, remote 164
- technical support, warranty 165
- technology, RAID 5

- telephone assistance 165
- text messages 142
- throughput 5
- tool bar 21, 41
- trademarks 184
- transfer speed, SCSI 36, 49
- transfer, parallel 5
- troubleshooting
 - disk array 142
 - ServeRAID 142
- type, controller 31

U

- unattended mode 52
- UNBLOCK command 132
- unblocking a logical drive 37, 48, 111, 150, 159
- understanding RAID technology 5
- UnixWare
 - device driver 60
 - device drivers, installing 82, 87
 - programs for 63
 - ServeRAID diskette, device drivers 2
- updates, obtaining 59
- using
 - Actions pull-down menu 44
 - administration and monitoring program 100
 - administration functions 105
 - advanced configuration functions 53
 - background-server component 89
 - command-line parameters 90
 - configuration mode 24
 - custom configuration 27, 28
 - express configuration 25, 26
 - File pull-down menu 42
 - information mode 30

using (*continued*)

- IPSMON program 139
- IPSEND program 127
- menu bar 42
- mini-configuration program 51
- Options pull-down menu 43, 100
- Pkgadd utility program 88
- right mouse button 29, 40, 44
- SCOAdmin utility program 88
- ServeRAID Configuration Program 20
- tool bar 41
- View pull-down menu 43

V

- vendor ID, drive 35, 36
- View pull-down menu 43
- viewing
 - adapter status 51, 52
 - array information 33
 - channel information 36
 - configuration information 31, 51
 - device information 31
 - events, viewer 21
 - hot-spare drive information 34
 - hot-swap rebuild setting 32
 - logical drive information 33
 - number of hot-spare drives 33
 - number of physical drives 33
 - physical drive information 35
 - rebuild rate 32
 - SCSI transfer speed 36
 - ServeRAID controller
 - information 31
 - stripe-unit size 32
 - system information 31

W

- warranty extensions and upgrades 169
- warranty service 165
- warranty statements 171
- WIN32-Based program 61, 99
- Windows
 - device driver 60
 - device drivers, installing 65, 66
 - programs for 61
 - ServeRAID diskette, device drivers 2
- World Wide Web
 - clustering information, obtaining 41, 44, 59, 60
 - code updates, obtaining 59
 - home page 161, 163
 - obtaining updated ServeRAID code 2
- write-cache mode 34



Part Number: 05L2054

Printed in U.S.A.

05L2054

