

**PC 300 Series
IntelliStation**

Volume 3:

**Hardware
Maintenance
Manual**

November 1999

**We Want Your Comments!
(Please see page 233)**

This Manual Supports:

300 Series, Type

6584

6594

IntelliStation, Type

6867

**PC 300 Series
IntelliStation**

Volume 3:

**Hardware
Maintenance
Manual**

November 1999

**We Want Your Comments!
(Please see page 233)**



Note

Before using this information and the product it supports, be sure to read the general information under "Notices" on page 242.

First Edition (November 1999)

The following paragraph does not apply to the United Kingdom or any country where such provisions are inconsistent with local law: INTERNATIONAL BUSINESS MACHINES CORPORATION PROVIDES THIS PUBLICATION "AS IS" WITHOUT WARRANTY OF ANY KIND, EITHER EXPRESS OR IMPLIED, INCLUDING, BUT NOT LIMITED TO, THE IMPLIED WARRANTIES OF MERCHANTABILITY OR FITNESS FOR A PARTICULAR PURPOSE. Some states do not allow disclaimer of express or implied warranties in certain transactions, therefore, this statement may not apply to you.

This publication could include technical inaccuracies or typographical errors. Changes are periodically made to the information herein; these changes will be incorporated in new editions of the publication. IBM may make improvements and/or changes in the product(s) and/or the program(s) described in this publication at any time.

This publication was developed for products and services offered in the United States of America. IBM may not offer the products, services, or features discussed in this document in other countries, and the information is subject to change without notice. Consult your local IBM representative for information on the products, services, and features available in your area.

Requests for technical information about IBM products should be made to your IBM reseller or IBM marketing representative.

© Copyright International Business Machines Corporation 1999. All rights reserved.

Note to U.S. Government users—Documentation related to Restricted rights—Use, duplication, or disclosure is subject to restrictions set forth in GSA ADP Schedule Contract with IBM Corp.

About this manual

This (Volume 3) manual contains service and reference information for the IBM Personal Computer 300 Series, and the IBM Profession Workstation IntelliStation Type computers listed in front of this manual.

For other type PC300/700, IntelliStation computers, refer to:

- IBM Personal Computer, Volume 1, Hardware Maintenance Manual, form number S83G-7789
- IBM Personal Computer, Volume 2, Hardware Maintenance Manual, (including the Aptiva 2173), form number, S00N-4019.

This manual is divided into product service sections, by type, and a related service section as follows:

- The product service sections include procedures for isolating problems to a FRU, a Symptom-to-FRU Index, additional service information, models listing, and an illustrated parts catalog.
- The related service section includes safety notices and safety information, and problem determination tips.

Important

This manual is intended for trained servicers who are familiar with IBM Personal Computer products. Use this manual along with advanced diagnostic tests to troubleshoot problems effectively.

Before servicing an IBM product, be sure to review the "Safety notices (multi-lingual translations)" on page 202 and "Safety information" on page 226.

Important safety information

Be sure to read all caution and danger statements in this book before performing any of the instructions.

Leia todas as instruções de cuidado e perigo antes de executar qualquer operação.

注意和危险声明(简体中文)

重要事项:

本书中的所有注意和危险声明之前都有编号。该编号用于英语的注意或危险声明与 *Safety Information* 一书中可以找到的翻译版本的注意或危险声明进行交叉引用。

例如，如果一个注意声明以编号 1 开始，那么对该注意声明的翻译出现在 *Safety Information* 一书中的声明 1 中。

在按说明执行任何操作前，请务必阅读所有注意和危险声明。

注意及危险声明(中文)

重要资讯:

本书中所有「注意」及「危险」的声明均以数字开始。此一数字是用来作为交互参考之用，英文「注意」或「危险」声明可在「安全资讯」(Safety Information) 一书中找到相同内容的「注意」或「危险」声明的译文。

例如，有一「危险」声明以数字 1 开始，则该「危险」声明的译文将出现在「安全资讯」(Safety Information) 一书的「声明」1 中。

执行任何指示之前，请详读所有「注意」及「危险」的声明。

Prenez connaissance de toutes les consignes de type Attention et Danger avant de procéder aux opérations décrites par les instructions.

Lesen Sie alle Sicherheitshinweise, bevor Sie eine Anweisung ausführen.

Accertarsi di leggere tutti gli avvisi di attenzione e di pericolo prima di effettuare qualsiasi operazione.

주의 및 위험 경고문(한글)

중요:

이 책에 나오는 모든 주의 및 위험 경고문은 번호로 시작됩니다. 이 번호는 *Safety Information* 책에 나오는 영문판 주의 및 위험 경고문과 한글판 주의 및 위험 경고문을 상호 참조하는데 사용됩니다.

예를 들어 주의 경고문이 번호 1로 시작되면 *Safety Information* 책에서 이 주의 경고문은 경고문 1번 아래에 나옵니다.

지시를 따라 수행하기 전에 먼저 모든 주의 및 위험 경고문을 읽도록 하십시오.

Lea atentamente todas las declaraciones de precaución y peligro ante de llevar a cabo cualquier operación.

Related publications

The following publications are available for IBM products. For more information, contact IBM or an IBM Authorized Dealer.

For Information About	See Publication
PC300/700 and IntelliStation computers - Volume 1 HMM	IBM Personal Computer Hardware Maintenance Manual Volume 1 (S83G-7789)
PC300 and IntelliStation computers (Including Aptiva 2173) - Volume 2 HMM	IBM Personal Computer Hardware Maintenance Manual Volume 2 (S00N-4019)
PS/2 Computers	IBM Personal System/2 Hardware Maintenance Manual (S52G-9971)
PS/ValuePoint Computers	IBM PS/ValuePoint Hardware Maintenance Service and Reference (S61G-1423)
Laptop, Notebook, Portable, and ThinkPad Computers (L40, CL57, N45, N51, P70/P75, ThinkPad 300, 350, 500, 510, 710T, Expansion Unit, Dock I, Dock II)	IBM Mobile Systems Hardware Maintenance Manual Volume 1 (S82G-1501)
ThinkPad Computers (ThinkPad 340, 355, 360, 370, 700, 701, 720, 750, 755)	IBM Mobile Systems Hardware Maintenance Manual Volume 2 (S82G-1502)
ThinkPad Computers (ThinkPad 365, 560, 760, SelectaDock)	IBM Mobile Systems Hardware Maintenance Manual Volume 3 (S82G-1503)
Monitors (Displays) (February 1993)	IBM PS/2 Display HMM Volume 1 (SA38-0053)
Monitors (December 1993)	IBM Color Monitor HMM Volume 2 (S71G-4197)
IBM Monitors (P/G Series) (June 1996)	IBM Monitor HMM Volume 3 (S52H-3679)
IBM 2248 Monitor (February 1996)	IBM Monitor HMM Volume 4 (S52H-3739)
Disk Array technology overview and using the IBM RAID Configuration Program	Configuring Your Disk Array booklet (S82G-1506)
Installation Planning for Personal System/2 computers	Personal System/2 Installation Planning and Beyond (G41G-2927)
Installation Planning for Advanced Personal System/2 Servers	Advanced PS/2 Servers Planning and Selection Guide (GG24-3927)

Contents

About this manual	iii
Important safety information	iii
Related publications	vi
IBM PC Enhanced Diagnostics error codes	1
PC 300 - 6584/6594	21
General checkout	24
Diagnostics and test information	32
Product description	43
Additional service information	46
Computer exploded view (Type 6584)	61
Computer exploded view (Type 6594)	70
System board layout	77
Riser cards (Type 6584)	79
Riser card (Type 6594)	81
Symptom-to-FRU index	82
Undetermined problem	104
Model tables - Country/Region/Language	105
Parts (Type 6584)	110
Parts (Type 6594)	112
IntelliStation - 6867	117
General checkout	120
Diagnostics and test information	128
Product description	139
Additional service information	141
Computer exploded view (Type 6867)	156
System board layout	165
Riser card (Type 6867)	167
Symptom-to-FRU index	168
Undetermined problem	190
Model tables - Country/Region/Language	191
Parts (Type 6867)	196
Related Service Information	201
Safety notices (multi-lingual translations)	202
Safety information	226
Miscellaneous information	231
Send us your comments!	233
Do you need technical references?	234
Problem determination tips	235
Notices	242

IBM PC Enhanced Diagnostics error codes

Refer to the following Diagnostic Error Codes when using the IBM PC Enhanced Diagnostics test. See “Diagnostic and test information” section for information about the IBM PC Enhanced Diagnostics program.

In the following index, “X” can represent any number.

Diagnostic Error Code	FRU/Action
000-000-XXX BIOS Test Passed	1. No action
000-002-XXX BIOS Timeout	1. Flash the system 2. System board
000-024-XXX BIOS Addressing test failure	1. Flash the system 2. System board
000-025-XXX BIOS Checksum Value error	1. Flash the system 2. Boot block 3. System board
000-026-XXX FLASH data error	1. Flash the system 2. Boot block 3. System board
000-027-XXX BIOS Configuration/Setup error	1. Run Setup 2. Flash the system 3. Boot block 4. System board
000-034-XXX BIOS Buffer Allocation failure	1. Reboot the system 2. Flash the system 3. Run memory test 4. System board
000-035-XXX BIOS Reset Condition detected	1. Flash the system 2. System board
000-036-XXX BIOS Register error	1. Flash the system 2. Boot block 3. System board
000-038-XXX BIOS Extension failure	1. Flash the system 2. Adapter card 3. System board
000-039-XXX BIOS DMI data error	1. Flash the system 2. System board
000-195-XXX BIOS Test aborted by user	1. Information 2. Re-start the test, if need to
000-196-XXX BIOS test halt, error threshold exceeded	1. Depress F3 to review the log file. 2. Re-start the test to reset the log file.

Diagnostic Error Code	FRU/Action
000-197-XXX BIOS test warning	<ol style="list-style-type: none"> 1. Make sure component that is called out is enabled and/or connected 2. Re-run test 3. Component that is called out in warning statement 4. Component under test
000-198-XXX BIOS test aborted	<ol style="list-style-type: none"> 1. If a component is called out, make sure it is enabled and/or connected 2. Flash the system and re-test 3. Go to the "Undetermined problem" section.
000-199-XXX BIOS test failed, cause unknown	<ol style="list-style-type: none"> 1. Go to "Undetermined problem" section. 2. Flash the system and re-test. 3. Replace component under function test.
000-250-XXX BIOS APM failure	<ol style="list-style-type: none"> 1. Flash the system 2. System board
000-270-XXX BIOS ACPI failure	<ol style="list-style-type: none"> 1. Flash the system 2. System board
001-000-XXX System Test Passed	<ol style="list-style-type: none"> 1. No action
001-00X-XXX System Error	<ol style="list-style-type: none"> 1. System board
001-01X-XXX System Error	<ol style="list-style-type: none"> 1. System board
001-024-XXX System Addressing test failure	<ol style="list-style-type: none"> 1. System board
001-025-XXX System Checksum Value error	<ol style="list-style-type: none"> 1. Flash the system 2. System board
001-026-XXX System FLASH data error	<ol style="list-style-type: none"> 1. Flash the system 2. System board
001-027-XXX System Configuration/Setup error	<ol style="list-style-type: none"> 1. Run Setup 2. Flash the system 3. System board
001-032-XXX System Device Controller failure	<ol style="list-style-type: none"> 1. System board
001-034-XXX System Device Buffer Allocation failure	<ol style="list-style-type: none"> 1. Reboot the system 2. Flash the system 3. Run memory test 4. System board

Diagnostic Error Code	FRU/Action
001-035-XXX System Device Reset condition detected	1. System board
001-036-XXX System Register error	1. System board
001-038-XXX System Extension failure	1. Adapter card 2. System board
001-039-XXX System DMI data structure error	1. Flash the system 2. System board
001-040-XXX System IRQ failure	1. Power-off/on system and re-test 2. System board
001-041-XXX System DMA failure	1. Power-off/on system and re-test 2. System board
001-195-XXX System Test aborted by user	1. Information 2. Re-start the test, if need to
001-196-XXX System test halt, error threshold exceeded	1. Depress F3 to review the log file. 2. Re-start the test to reset the log file.
001-197-XXX System test warning	1. Make sure component that is called out is enabled and/or connected 2. Re-run test 3. Component that is called out in warning statement 4. Component under test
001-198-XXX System test aborted	1. If a component is called out, make sure it is enabled and/or connected 2. Flash the system and re-test 3. Go to "Undetermined problem" section.
001-199-XXX System test failed, cause unknown	1. Go to "Undetermined problem" section. 2. Flash the system and re-test 3. Replace component under function test.
001-250-XXX System ECC error	1. System board
001-254-XXX 001-255-XXX 001-256-XXX 001-257-XXX System DMA error	1. System board

Diagnostic Error Code	FRU/Action
001-260-XXX 001-264-XXX System IRQ error	1. System board
001-268-XXX System IRQ1 failure	1. device on IRQ1 2. System board
001-269-XXX System IRQ2 failure	1. device on IRQ2 2. System board
001-270-XXX System IRQ3 failure	1. device on IRQ3 2. System board
001-271-XXX System IRQ4 failure	1. device on IRQ4 2. System board
001-272-XXX System IRQ5 failure	1. device on IRQ5 2. System board
001-273-XXX System IRQ6 (diskette drive) failure	1. Diskette Cable 2. Diskette drive 3. System board
001-274-XXX System IRQ7 failure	1. device on IRQ7 2. System board
001-275-XXX System IRQ8 failure	1. device on IRQ8 2. System board
001-276-XXX System IRQ9 failure	1. device on IRQ9 2. System board
001-277-XXX System IRQ10 failure	1. device on IRQ10 2. System board
001-278-XXX System IRQ11 failure	1. device on IRQ11 2. System board
001-279-XXX System IRQ12 failure	1. device on IRQ12 2. System board
001-280-XXX System IRQ13 failure	1. device on IRQ13 2. System board
001-281-XXX System IRQ14 (hard disk drive) failure	1. Hard disk drive Cable 2. Hard disk drive 3. System board
001-282-XXX System IRQ15 failure	1. device on IRQ15 2. System board
001-286-XXX 001-287-XXX 001-288-XXX System Timer failure	1. System board
001-292-XXX System CMOS RAM error	1. Run Setup and re-test 2. System board
001-293-XXX System CMOS Battery	1. Battery 2. System board
001-298-XXX System RTC date/time update failure	1. Flash the system 2. System board
001-299-XXX System RTC periodic interrupt failure	1. System board

Diagnostic Error Code	FRU/Action
001-300-XXX System RTC Alarm failure	1. System board
001-301-XXX System RTC Century byte error	1. Flash the system 2. System board
005-000-XXX Video Test Passed	1. No action
005-00X-XXX Video error	1. Video card, if installed 2. System board
005-010-XXX 005-011-XXX 005-012-XXX 005-013-XXX Video Signal failure	1. Video card, if installed 2. System board
005-016-XXX Video Simple Pattern test failure	1. Video Ram 2. Video card, if installed 3. System board
005-024-XXX Video Addressing test failure	1. Video card, if installed 2. System board
005-025-XXX Video Checksum Value error	1. Video card, if installed 2. System board
005-027-XXX Video Configuration/Setup error	1. Run Setup 2. Video drivers update 3. Video card, if installed 4. System board
005-031-XXX Video Device Cable failure	1. Video cable 2. Monitor 3. Video card, if installed 4. System board
005-032-XXX Video Device Controller failure	1. Video card, if installed 2. System board
005-036-XXX Video Register error	1. Video card, if installed 2. System board
005-038-XXX System BIOS extension failure	1. Video card, if installed 2. System board
005-040-XXX Video IRQ failure	1. Video card, if installed 2. System board
005-195-XXX Video Test aborted by user	1. Information 2. Re-start the test, if need to
005-196-XXX Video test halt, error threshold exceeded	1. Depress F3 to review the log file. 2. Re-start the test to reset the log file.

Diagnostic Error Code	FRU/Action
005-197-XXX Video test warning	<ol style="list-style-type: none"> 1. Make sure component that is called out is enabled and/or connected 2. Re-run test 3. Component that is called out in warning statement 4. Component under test
005-198-XXX Video test aborted	<ol style="list-style-type: none"> 1. If a component is called out, make sure it is enabled and/or connected 2. Flash the system and re-test 3. Go to "Undetermined problem" section.
005-199-XXX Video test failed, cause unknown	<ol style="list-style-type: none"> 1. Go to "Undetermined problem" section. 2. Flash the system and re-test 3. Replace component under function test.
005-2XX-XXX 005-3XX-XXX Video subsystem error	<ol style="list-style-type: none"> 1. Video card, if installed 2. System board
006-000-XXX Diskette interface Test Passed	<ol style="list-style-type: none"> 1. No action
006-0XX-XXX Diskette interface error	<ol style="list-style-type: none"> 1. Diskette drive Cable 2. Diskette drive 3. System board
006-195-XXX Diskette interface Test aborted by user	<ol style="list-style-type: none"> 1. Information 2. Re-start the test, if need to
006-196-XXX Diskette interface test halt, error threshold exceeded	<ol style="list-style-type: none"> 1. Depress F3 to review the log file. 2. Re-start the test to reset the log file.
006-197-XXX Diskette interface test warning	<ol style="list-style-type: none"> 1. Make sure component that is called out is enabled and/or connected 2. Re-run test 3. Component that is called out in warning statement 4. Component under test

Diagnostic Error Code	FRU/Action
006-198-XXX Diskette interface test aborted	<ol style="list-style-type: none"> 1. If a component is called out, make sure it is enabled and/or connected 2. Flash the system and re-test 3. Go to "Undetermined problem" section.
006-199-XXX Diskette interface test failed, cause unknown	<ol style="list-style-type: none"> 1. Go to "Undetermined problem" section. 2. Flash the system and re-test 3. Replace component under function test.
006-25X-XXX Diskette interface Error	<ol style="list-style-type: none"> 1. Diskette drive Cable 2. Diskette drive 3. System board
011-000-XXX Serial port Interface Test Passed	<ol style="list-style-type: none"> 1. No action
011-001-XXX Serial port Presence	<ol style="list-style-type: none"> 1. Remove external serial device, if present 2. Run setup, enable port 3. System board
011-002-XXX 011-003-XXX Serial port Timeout/Parity error	<ol style="list-style-type: none"> 1. System board
011-013-XXX 011-014-XXX Serial port Control Signal/Loopback test failure	<ol style="list-style-type: none"> 1. System board
011-015-XXX Serial port External Loopback failure	<ol style="list-style-type: none"> 1. Wrap plug 2. System board
011-027-XXX Serial port Configuration/Setup error	<ol style="list-style-type: none"> 1. Run Setup, enable port 2. Flash the system 3. System board
011-03X-XXX 011-04X-XXX Serial port failure	<ol style="list-style-type: none"> 1. System board
011-195-XXX Serial port Test aborted by user	<ol style="list-style-type: none"> 1. Information 2. Re-start the test, if need to
011-196-XXX Serial port test halt, error threshold exceeded	<ol style="list-style-type: none"> 1. Depress F3 to review the log file. 2. Re-start the test to reset the log file.

Diagnostic Error Code	FRU/Action
011-197-XXX Serial port test warning	<ol style="list-style-type: none"> 1. Make sure component that is called out is enabled and/or connected 2. Re-run test 3. Component that is called out in warning statement 4. Component under test
011-198-XXX Serial port test aborted	<ol style="list-style-type: none"> 1. If a component is called out, make sure it is enabled and/or connected 2. Flash the system and re-test 3. Go to "Undetermined problem" section.
011-199-XXX Serial port test failed, cause unknown	<ol style="list-style-type: none"> 1. Go to "Undetermined problem" section. 2. Flash the system and re-test 3. Replace component under function test.
011-2XX-XXX Serial port signal failure	<ol style="list-style-type: none"> 1. External serial device 2. System board
014-000-XXX Parallel port Interface Test Passed	<ol style="list-style-type: none"> 1. No action
014-001-XXX Parallel port Presence	<ol style="list-style-type: none"> 1. Remove external parallel device, if present 2. Run setup, enable port 3. System board
014-002-XXX 014-003-XXX Parallel port Timeout/Parity error	<ol style="list-style-type: none"> 1. System board
014-013-XXX 014-014-XXX Parallel port Control Signal/Loopback test failure	<ol style="list-style-type: none"> 1. System board
014-015-XXX Parallel port External Loopback failure	<ol style="list-style-type: none"> 1. Wrap plug 2. System board
014-027-XXX Parallel port Configuration/Setup error	<ol style="list-style-type: none"> 1. Run Setup, enable port 2. Flash the system 3. System board
014-03X-XXX 014-04X-XXX Parallel port failure	<ol style="list-style-type: none"> 1. System board
014-195-XXX Parallel port Test aborted by user	<ol style="list-style-type: none"> 1. Information 2. Re-start the test, if need to

Diagnostic Error Code	FRU/Action
014-196-XXX Parallel port test halt, error threshold exceeded	<ol style="list-style-type: none"> 1. Depress F3 to review the log file. 2. Re-start the test to reset the log file.
014-197-XXX Parallel port test warning	<ol style="list-style-type: none"> 1. Make sure component that is called out is enabled and/or connected 2. Re-run test 3. Component that is called out in warning statement 4. Component under test
014-198-XXX Parallel port test aborted	<ol style="list-style-type: none"> 1. If a component is called out, make sure it is enabled and/or connected 2. Flash the system and re-test 3. Go to "Undetermined problem" section.
014-199-XXX Parallel port test failed, cause unknown	<ol style="list-style-type: none"> 1. Go to "Undetermined problem" section. 2. Flash the system and re-test 3. Replace component under function test.
014-2XX-XXX 014-3XX-XXX Parallel port failure	<ol style="list-style-type: none"> 1. External parallel device 2. System board
015-000-XXX USB port Interface Test Passed	<ol style="list-style-type: none"> 1. No action
015-001-XXX USB port Presence	<ol style="list-style-type: none"> 1. Remove USB Device(s) and re-test 2. System board
015-002-XXX USB port Timeout	<ol style="list-style-type: none"> 1. Remove USB Device(s) and re-test 2. System board
015-015-XXX USB port External Loopback failure	<ol style="list-style-type: none"> 1. Remove USB Device(s) and re-test 2. System board
015-027-XXX USB port Configuration/Setup error	<ol style="list-style-type: none"> 1. Flash the system 2. System board
015-032-XXX USB port Device Controller failure	<ol style="list-style-type: none"> 1. System board
015-034-XXX USB port buffer allocation failure	<ol style="list-style-type: none"> 1. Reboot the system 2. Flash the system 3. Run memory test 4. System board

Diagnostic Error Code	FRU/Action
015-035-XXX USB port Reset condition detected	<ol style="list-style-type: none"> 1. Remove USB Device(s) and re-test 2. System board
015-036-XXX USB port Register error	<ol style="list-style-type: none"> 1. System board
015-040-XXX USB port IRQ failure	<ol style="list-style-type: none"> 1. Run setup and check for conflicts 2. Flash the system 3. System board
015-195-XXX USB port Test aborted by user	<ol style="list-style-type: none"> 1. Information 2. Re-start the test, if need to
015-196-XXX USB port test halt, error threshold exceeded	<ol style="list-style-type: none"> 1. Depress F3 to review the log file. 2. Re-start the test to reset the log file.
015-197-XXX USB port test warning	<ol style="list-style-type: none"> 1. Make sure component that is called out is enabled and/or connected 2. Re-run test 3. Component that is called out in warning statement 4. Component under test
015-198-XXX USB port test aborted	<ol style="list-style-type: none"> 1. If a component is called out, make sure it is enabled and/or connected 2. Flash the system and re-test 3. Go to "Undetermined problem" section.
015-199-XXX USB port test failed, cause unknown	<ol style="list-style-type: none"> 1. Go to "Undetermined problem" section. 2. Flash the system and re-test 3. Replace component under function test.
018-000-XXX PCI Card Test Passed	<ol style="list-style-type: none"> 1. No action
018-0XX-XXX PCI Card Failure	<ol style="list-style-type: none"> 1. PCI card 2. Riser card, if installed 3. System board
018-195-XXX PCI Card Test aborted by user	<ol style="list-style-type: none"> 1. Information 2. Re-start the test, if need to
018-196-XXX PCI Card test halt, error threshold exceeded	<ol style="list-style-type: none"> 1. Depress F3 to review the log file. 2. Re-start the test to reset the log file.

Diagnostic Error Code	FRU/Action
018-197-XXX PCI Card test warning	<ol style="list-style-type: none"> 1. Make sure component that is called out is enabled and/or connected 2. Re-run test 3. Component that is called out in warning statement 4. Component under test
018-198-XXX PCI Card test aborted	<ol style="list-style-type: none"> 1. If a component is called out, make sure it is enabled and/or connected 2. Flash the system and re-test 3. Go to "Undetermined problem" section.
018-199-XXX PCI Card test failed, cause unknown	<ol style="list-style-type: none"> 1. Go to "Undetermined problem" section. 2. Flash the system and re-test 3. Replace component under function test.
018-250-XXX PCI Card Services error	<ol style="list-style-type: none"> 1. PCI card 2. Riser card, if installed 3. System board
020-000-XXX PCI Interface Test Passed	<ol style="list-style-type: none"> 1. No action
020-0XX-XXX PCI Interface error	<ol style="list-style-type: none"> 1. PCI card 2. Riser card, if installed 3. System board
020-195-XXX PCI Test aborted by user	<ol style="list-style-type: none"> 1. Information 2. Re-start the test, if need to
020-196-XXX PCI test halt, error threshold exceeded	<ol style="list-style-type: none"> 1. Depress F3 to review the log file. 2. Re-start the test to reset the log file.
020-197-XXX PCI test warning	<ol style="list-style-type: none"> 1. Make sure component that is called out is enabled and/or connected 2. Re-run test 3. Component that is called out in warning statement 4. Component under test
020-198-XXX PCI test aborted	<ol style="list-style-type: none"> 1. If a component is called out, make sure it is enabled and/or connected 2. Flash the system and re-test 3. Go to "Undetermined problem" section.

Diagnostic Error Code	FRU/Action
020-199-XXX PCI test failed, cause unknown	<ol style="list-style-type: none"> 1. Go to “Undetermined problem” section. 2. Flash the system and re-test 3. Replace component under function test.
020-262-XXX PCI system error	<ol style="list-style-type: none"> 1. PCI card 2. Riser card, if installed 3. System board
025-000-XXX IDE interface Test Passed	<ol style="list-style-type: none"> 1. No action
025-00X-XXX 025-01X-XXX IDE interface failure	<ol style="list-style-type: none"> 1. IDE signal cable 2. Check power supply 3. IDE device 4. System board
025-027-XXX IDE interface Configuration/Setup error	<ol style="list-style-type: none"> 1. IDE signal cable 2. Flash the system 3. IDE device 4. System board
025-02X-XXX 025-03X-XXX 025-04X-XXX IDE Interface failure	<ol style="list-style-type: none"> 1. IDE signal cable 2. Check power supply 3. IDE device 4. System board
025-195-XXX IDE interface Test aborted by user	<ol style="list-style-type: none"> 1. Information 2. Re-start the test, if need to
025-196-XXX IDE interface test halt, error threshold exceeded	<ol style="list-style-type: none"> 1. Depress F3 to review the log file. 2. Re-start the test to reset the log file.
025-197-XXX IDE interface test warning	<ol style="list-style-type: none"> 1. Make sure component that is called out is enabled and/or connected 2. Re-run test 3. Component that is called out in warning statement 4. Component under test
025-198-XXX IDE interface test aborted	<ol style="list-style-type: none"> 1. If a component is called out, make sure it is enabled and/or connected 2. Flash the system and re-test 3. Go to “Undetermined problem” section.
025-199-XXX IDE interface test failed, cause unknown	<ol style="list-style-type: none"> 1. Go to “Undetermined problem” section. 2. Flash the system and re-test 3. Replace component under function test.

Diagnostic Error Code	FRU/Action
030-000-XXX SCSI interface Test Passed	1. No action
030-00X-XXX 030-01X-XXX SCSI interface failure	1. SCSI signal cable 2. Check power supply 3. SCSI device 4. SCSI adapter card, if installed 5. System board
030-027-XXX SCSI interface Configuration/Setup error	1. SCSI signal cable 2. Flash the system 3. SCSI device 4. SCSI adapter card, if installed 5. System board
030-03X-XXX 030-04X-XXX SCSI interface error	1. SCSI signal cable 2. Check power supply 3. SCSI device 4. SCSI adapter card, if installed 5. System board
030-195-XXX SCSI interface Test aborted by user	1. Information 2. Re-start the test, if need to
030-196-XXX SCSI interface test halt, error threshold exceeded	1. Depress F3 to review the log file. 2. Re-start the test to reset the log file.
030-197-XXX SCSI interface test warning	1. Make sure component that is called out is enabled and/or connected 2. Re-run test 3. Component that is called out in warning statement 4. Component under test
030-198-XXX SCSI interface test aborted	1. If a component is called out, make sure it is enabled and/or connected 2. Flash the system and re-test 3. Go to "Undetermined problem" section.
030-199-XXX SCSI interface test failed, cause unknown	1. Go to "Undetermined problem" section. 2. Flash the system and re-test 3. Replace component under function test.
035-000-XXX RAID interface Test Passed	1. No action

Diagnostic Error Code	FRU/Action
035-0XX-XXX RAID interface Failure	<ol style="list-style-type: none"> 1. RAID signal cable 2. RAID device 3. RAID adapter card, if installed 4. System board
035-195-XXX RAID interface Test aborted by user	<ol style="list-style-type: none"> 1. Information 2. Re-start the test, if need to
035-196-XXX RAID interface test halt, error threshold exceeded	<ol style="list-style-type: none"> 1. Depress F3 to review the log file. 2. Re-start the test to reset the log file.
035-197-XXX RAID interface test warning	<ol style="list-style-type: none"> 1. Make sure component that is called out is enabled and/or connected 2. Re-run test 3. Component that is called out in warning statement 4. Component under test
035-198-XXX RAID interface test aborted	<ol style="list-style-type: none"> 1. If a component is called out, make sure it is enabled and/or connected 2. Flash the system and re-test 3. Go to "Undetermined problem" section.
035-199-XXX RAID interface test failed, cause unknown	<ol style="list-style-type: none"> 1. Go to "Undetermined problem" section. 2. Flash the system and re-test 3. Replace component under function test.
071-000-XXX Audio port Interface Test Passed	<ol style="list-style-type: none"> 1. No action
071-00X-XXX 071-01X-XXX 071-02X-XXX Audio port error	<ol style="list-style-type: none"> 1. Run Setup 2. Flash the system 3. System board
071-03X-XXX Audio port failure	<ol style="list-style-type: none"> 1. Speakers 2. Microphone 3. Audio card, if installed 4. System board
071-04X-XXX Audio port failure	<ol style="list-style-type: none"> 1. Run Setup 2. Audio card, if installed 3. System board
071-195-XXX Audio port Test aborted by user	<ol style="list-style-type: none"> 1. Information 2. Re-start the test, if need to

Diagnostic Error Code	FRU/Action
071-196-XXX Audio port test halt, error threshold exceeded	<ol style="list-style-type: none"> 1. Depress F3 to review the log file. 2. Re-start the test to reset the log file.
071-197-XXX Audio port test warning	<ol style="list-style-type: none"> 1. Make sure component that is called out is enabled and/or connected 2. Re-run test 3. Component that is called out in warning statement 4. Component under test
071-198-XXX Audio port test aborted	<ol style="list-style-type: none"> 1. If a component is called out, make sure it is enabled and/or connected 2. Flash the system and re-test 3. Go to "Undetermined problem" section.
071-199-XXX Audio port test failed, cause unknown	<ol style="list-style-type: none"> 1. Go to "Undetermined problem" section. 2. Flash the system and re-test 3. Replace component under function test.
071-25X-XXX Audio port failure	<ol style="list-style-type: none"> 1. Speakers 2. Audio card, if installed 3. System board
080-000-XXX Game Port interface Test Passed	<ol style="list-style-type: none"> 1. No action
080-XXX-XXX Game Port interface Error	<ol style="list-style-type: none"> 1. Remove the game port device and re-test the system
080-195-XXX Game Port interface Test aborted by user	<ol style="list-style-type: none"> 1. Information 2. Re-start the test, if need to
080-196-XXX Game Port interface test halt, error threshold exceeded	<ol style="list-style-type: none"> 1. Depress F3 to review the log file. 2. Re-start the test to reset the log file.
080-197-XXX Game Port interface test warning	<ol style="list-style-type: none"> 1. Make sure component that is called out is enabled and/or connected 2. Re-run test 3. Component that is called out in warning statement 4. Component under test

Diagnostic Error Code	FRU/Action
080-198-XXX Game Port interface test aborted	<ol style="list-style-type: none"> 1. If a component is called out, make sure it is enabled and/or connected 2. Flash the system and re-test 3. Go to "Undetermined problem" section.
080-199-XXX Game Port interface test failed, cause unknown	<ol style="list-style-type: none"> 1. Go to "Undetermined problem" section. 2. Flash the system and re-test 3. Replace component under function test.
086-000-XXX Mouse Port interface Test Passed	<ol style="list-style-type: none"> 1. No action
086-001-XXX Mouse Port interface Presence	<ol style="list-style-type: none"> 1. Mouse 2. System board
086-032-XXX Mouse Port interface Device controller failure	<ol style="list-style-type: none"> 1. Mouse 2. System board
086-035-XXX Mouse Port interface Reset	<ol style="list-style-type: none"> 1. Mouse 2. System board
086-040-XXX Mouse Port interface IRQ failure	<ol style="list-style-type: none"> 1. Run Setup 2. Mouse 3. System board
086-195-XXX Mouse Port interface Test aborted by user	<ol style="list-style-type: none"> 1. Information 2. Re-start the test, if need to
086-196-XXX Mouse Port interface test halt, error threshold exceeded	<ol style="list-style-type: none"> 1. Depress F3 to review the log file. 2. Re-start the test to reset the log file.
086-197-XXX Mouse Port interface test warning	<ol style="list-style-type: none"> 1. Make sure component that is called out is enabled and/or connected 2. Re-run test 3. Component that is called out in warning statement 4. Component under test
086-198-XXX Mouse Port interface test aborted	<ol style="list-style-type: none"> 1. If a component is called out, make sure it is enabled and/or connected 2. Flash the system and re-test 3. Go to "Undetermined problem" section.

Diagnostic Error Code	FRU/Action
086-199-XXX Mouse Port interface test failed, cause unknown	<ol style="list-style-type: none"> 1. Go to “Undetermined problem” section. 2. Flash the system and re-test 3. Replace component under function test.
089-000-XXX Microprocessor Test Passed	<ol style="list-style-type: none"> 1. No action
089-XXX-XXX Microprocessor failure	<ol style="list-style-type: none"> 1. Microprocessor(s) 2. System board
089-195-XXX Microprocessor Test aborted by user	<ol style="list-style-type: none"> 1. Information 2. Re-start the test, if need to
089-196-XXX Microprocessor test halt, error threshold exceeded	<ol style="list-style-type: none"> 1. Depress F3 to review the log file. 2. Re-start the test to reset the log file.
089-197-XXX Microprocessor test warning	<ol style="list-style-type: none"> 1. Make sure component that is called out is enabled and/or connected 2. Re-run test 3. Component that is called out in warning statement 4. Component under test
089-198-XXX Microprocessor test aborted	<ol style="list-style-type: none"> 1. If a component is called out, make sure it is enabled and/or connected 2. Flash the system and re-test 3. Go to “Undetermined problem” section.
089-199-XXX Microprocessor test failed, cause unknown	<ol style="list-style-type: none"> 1. Go to “Undetermined problem” section. 2. Flash the system and re-test 3. Replace component under function test.
170-000-XXX Voltage Sensor(s) Test Passed	<ol style="list-style-type: none"> 1. No action
170-0XX-XXX Voltage Sensor(s) failure	<ol style="list-style-type: none"> 1. Flash system 2. System board
170-195-XXX Voltage Sensor(s) Test aborted by user	<ol style="list-style-type: none"> 1. Information 2. Re-start the test, if need to
170-196-XXX Voltage Sensor(s) test halt, error threshold exceeded	<ol style="list-style-type: none"> 1. Depress F3 to review the log file. 2. Re-start the test to reset the log file.

Diagnostic Error Code	FRU/Action
170-197-XXX Voltage Sensor(s) test warning	<ol style="list-style-type: none"> 1. Make sure component that is called out is enabled and/or connected 2. Re-run test 3. Component that is called out in warning statement 4. Component under test
170-198-XXX Voltage Sensor(s) test aborted	<ol style="list-style-type: none"> 1. If a component is called out, make sure it is enabled and/or connected 2. Flash the system and re-test 3. Go to "Undetermined problem" section.
170-199-XXX Voltage Sensor(s) test failed, cause unknown	<ol style="list-style-type: none"> 1. Go to "Undetermined problem" section. 2. Flash the system and re-test 3. Replace component under function test.
170-250-XXX 170-251-XXX Voltage Sensor(s) Voltage limit error	<ol style="list-style-type: none"> 1. Power supply 2. System board
170-254-XXX Voltage Sensor(s) Voltage Regulator Module error	<ol style="list-style-type: none"> 1. Voltage Regulator Module (VRM) 2. Microprocessor 3. System board
175-000-XXX Thermal Sensor(s) Test Passed	<ol style="list-style-type: none"> 1. No action
175-0XX-XXX Thermal Sensor(s) failure	<ol style="list-style-type: none"> 1. Flash system 2. System board
175-195-XXX Thermal Sensor(s) Test aborted by user	<ol style="list-style-type: none"> 1. Information 2. Re-start the test, if need to
175-196-XXX Thermal Sensor(s) test halt, error threshold exceeded	<ol style="list-style-type: none"> 1. Depress F3 to review the log file. 2. Re-start the test to reset the log file.
175-197-XXX Thermal Sensor(s) test warning	<ol style="list-style-type: none"> 1. Make sure component that is called out is enabled and/or connected 2. Re-run test 3. Component that is called out in warning statement 4. Component under test

Diagnostic Error Code	FRU/Action
175-198-XXX Thermal Sensor(s) test aborted	<ol style="list-style-type: none"> 1. If a component is called out, make sure it is enabled and/or connected 2. Flash the system and re-test 3. Go to "Undetermined problem" section.
175-199-XXX Thermal Sensor(s) test failed, cause unknown	<ol style="list-style-type: none"> 1. Go to "Undetermined problem" section. 2. Flash the system and re-test 3. Replace component under function test.
175-250-XXX 175-251-XXX Thermal Sensor(s) limit error	<ol style="list-style-type: none"> 1. Check fans 2. Check Power supply 3. Microprocessor 4. System board
185-000-XXX Asset Security Test Passed	<ol style="list-style-type: none"> 1. No action
185-XXX-XXX Asset Security failure	<ol style="list-style-type: none"> 1. Assure Asset Security Enabled 2. Flash system 3. System board
185-278-XXX Asset Security Chassis Intrusion	<ol style="list-style-type: none"> 1. C2 Cover Switch 2. System board
201-000-XXX System Memory Test Passed	<ol style="list-style-type: none"> 1. No action
201-XXX-XXX System Memory error	<ol style="list-style-type: none"> 1. Replace the memory module called out by the test 2. System board
202-000-XXX System Cache Test Passed	<ol style="list-style-type: none"> 1. No action
202-XXX-XXX System Cache error	<ol style="list-style-type: none"> 1. Cache, if removable 2. System board 3. Microprocessor
206-000-XXX Diskette Drive Test Passed	<ol style="list-style-type: none"> 1. No action
206-XXX-XXX Diskette Drive error	<ol style="list-style-type: none"> 1. Diskette Drive Cable 2. Check power supply voltages 3. Diskette drive 4. System board
215-000-XXX CD-ROM Drive Test Passed	<ol style="list-style-type: none"> 1. No action
215-XXX-XXX CD-ROM Drive error	<ol style="list-style-type: none"> 1. CD-ROM Drive Cable 2. Check power supply voltages 3. CD-ROM drive 4. System board

Diagnostic Error Code	FRU/Action
217-000-XXX Hard Disk Drive Test Passed	1. No action
217-25X-XXX 217-26X-XXX Hard Disk Drive (IDE) error	1. Hard Disk Drive Cable 2. Check power supply voltages 3. Hard Disk drive (IDE) 4. System board
217-28X-XXX 217-29X-XXX Hard Disk Drive (SCSI) error	1. Hard Disk Drive Cable 2. Check power supply voltages 3. Hard Disk drive (SCSI) 4. SCSI adapter card 5. System board
220-000-XXX Hi-Capacity Cartridge Drive Test Passed	1. No action
220-XXX-XXX Hi-Capacity Cartridge Drive error	1. Remove the Hi-Capacity Cartridge Drive and re-test the system
301-000-XXX Keyboard Test Passed	1. No action
301-XXX-XXX Keyboard error	1. Keyboard 2. Check and test Mouse 3. System board
302-000-XXX Mouse Test Passed	1. No action
302-XXX-XXX Mouse error	1. Mouse 2. Check and test Keyboard 3. System board
303-000-XXX Joystick Test Passed	1. No action
303-XXX-XXX Joystick error	1. Remove the Joystick and re-test the system
305-000-XXX Monitor DDC Test Passed	1. No action
305-250-XXX Monitor DDC self test failure	1. Run Setup to enable DDC 2. Cable 3. Monitor 4. Video card 5. System board
415-000-XXX Modem Test Passed	1. No action
415-XXX-XXX Modem error	1. Remove the Modem and re-test the system

PC 300 - 6584/6594

This section contains the general checkout procedures, additional service information, computer exploded view, Symptom-to-FRU indexes, undetermined problem, model tables, and parts listings for the IBM PC 300, type 6584/6594 computer.

Note

Service information is the same for types 6584/6594 computers, unless specifically identified as type 6584 which is the desktop computer.

Note

This manual and the diagnostic tests are intended to test **only** IBM products. Non-IBM products of any kind including adapter cards, accelerator boards, options, or non-IBM devices, can give false errors and invalid computer responses. If you remove a non-IBM device and the symptom goes away, the problem is with the device you removed.

General checkout	24
Module test menu and hardware configuration report	27
Keyboard	28
Printer	28
Power supply	29
20-pin main power supply connection	30
Display	31
Diagnostics and test information	32
Power-on self-test (POST)	32
POST beep codes	32
Error code format	33
IBM PC Enhanced Diagnostics	34
Starting the IBM PC Enhanced Diagnostics Program	34
Navigating through the diagnostic programs	34
Running diagnostic tests	35
Test selection	35
IBM PC Enhanced Memory Diagnostics	35
Alert On LAN test	36
Asset ID test	36
Test results	36
Hard File Smart Test	37
IBM Fixed Disk Optimized Test	37
Quick and Full erase - hard drive	38
Iomega Zip Drive Test	38
Asset EEPROM backup	38
Viewing the test log	39
RIMM memory errors	39
Setup Utility program	41

Hard disk drive boot error	41
When to use the Low-Level Format program . . .	42
Preparing the hard disk drive for use	42
Product description	43
Specifications Type 6584	44
Specifications Type 6594	45
Additional service information	46
Replacing a processor	46
Replacing a system board	47
Security features	47
Passwords	47
Power-on password	48
Administrator password	49
Administrator password control	49
Operating system password	49
Vital Product Data	49
Management Information Format (MIF)	49
Alert on LAN2	50
Hard disk drive jumper settings	51
IDE hard disk drive settings	51
CD-ROM drive jumper settings	52
BIOS levels	53
Flash (BIOS/VPD) update procedure	54
Flash recovery boot block	54
Power management	55
Automatic configuration and power interface (ACPI) BIOS	55
Advanced Power Management	55
Automatic Hardware Power Management features	55
Setting Automatic Hardware Power Management features	56
Automatic Power-On features	56
Network settings	57
Flash over LAN (update POST/BIOS over network)	57
Wake on LAN	58
System board memory	59
RIMM diagnostic approach	59
Computer exploded view (Type 6584)	61
Input/Output connectors	62
Top and front cover removal	63
CD-ROM/hard drive bracket	64
CD-ROM drive removal	64
Hard drive removal	65
EIDE cable routing	65
SCSI cable routing	65
Diskette drive removal	66
System board removal	67
System board installation	67
Riser card removal	68
Power supply removal	68
Fan and speaker bracket removal	69
Computer exploded view (Type 6594)	70
Input/Output connectors	71

Access cover removal	72
Top handle cover removal	72
Front bezel removal/replacement	73
System board removal	74
System board installation	74
Hard disk bracket removal	74
Hard disk drive in non removable drive cage	75
Tab removal	76
Fan cage, air baffle, speaker/card guide removal	76
System board layout	77
System board locations	77
System board jumper settings	78
Riser cards (Type 6584)	79
Riser card (Type 6594)	81
Symptom-to-FRU index	82
Beep symptoms	83
No beep symptoms	84
POST error codes	86
Miscellaneous error messages	101
Undetermined problem	104
Model tables - Country/Region/Language	105
Type/Model configuration tables (6584/6594)	106
Parts (Type 6584)	110
Parts listing	111
Parts (Type 6594)	112
Parts listing	113
Special tools	116

General checkout

This general checkout procedure is for Type 6584/6594 computers.

Attention

The drives in the computer you are servicing might have been rearranged or the drive startup sequence changed. Be extremely careful during write operations such as copying, saving, or formatting. Data or programs can be overwritten if you select an incorrect drive.

Diagnostic error messages appear when a test program finds a problem with a hardware option. For the test programs to properly determine if a test *Passed*, *Failed*, or *Aborted*, the test programs check the error-return code at test completion. See "IBM PC Enhanced Diagnostics" on page 34.

General error messages appear if a problem or conflict is found by an application program, the operating system, or both. For an explanation of these messages, refer to the information supplied with that software package.

Notes

1. Before replacing any FRUs, ensure the latest level of BIOS is installed on the system. A down-level BIOS might cause false errors and unnecessary replacement of the system board. For more information on how to determine and obtain the latest level BIOS, see "BIOS levels" on page 53.
2. If multiple error codes are displayed, diagnose the first error code displayed.
3. If the computer hangs with a POST error, go to "Symptom-to-FRU index" on page 82.
4. If the computer hangs and no error is displayed, go to "Undetermined problem" on page 104.
5. If an installed device is not recognized by the diagnostics program, that device might be defective.

The power-on default is quick bring-up. To enable Enhanced bring-up, select the **Start Options** in the Configuration/Setup Utility program (see "Setup Utility program" on page 41) then, enable **Power On Status**.

001

- Power-off the computer and all external devices.
- Check all cables and power cords.
- Make sure the system board is seated properly.
- Set all display controls to the middle position.

(Step **001** continues)

001 (continued)

- Insert the IBM PC Enhanced Diagnostics diskette into drive A.
- Power-on all external devices.
- Power-on the computer.
- Check for the following response:
 1. Readable instructions or the Main Menu.

Note

Type 6584/6594 computers default to come up quiet (No beep and no memory count and checkpoint code display) when no errors are detected by POST.

To enable Beep and memory count and checkpoint code display when a successful POST occurs:

- Enable **Power on Status** in setup. See “Setup Utility program” on page 41.

DID YOU RECEIVE THE CORRECT RESPONSE?

Yes No

002

If the Power Management feature is enabled, do the following:

1. Start the Configuration/Setup Utility program (see “Setup Utility program” on page 41)
2. Select **Power Management** from the Configuration/Setup Utility program menu.
3. Select **APM**
4. Be sure **APM BIOS Mode** is set to **Disabled**. If it is not, press Left Arrow (←) or Right Arrow (→) to change the setting.
5. Select **Automatic Hardware Power Management**.
6. Set **Automatic Hardware Power Management** to **Disabled**.

– or –

Go to the “IBM PC Enhanced Diagnostics” on page 34.

003

Run the IBM PC Enhanced Diagnostics test. If necessary, refer to “Diagnostics and test information” on page 32.

- If you receive an error, replace the part that the diagnostic program calls out or go to “IBM PC Enhanced Diagnostics” on page 34.
- If the test stops and you cannot continue, replace the last device tested.
- If the computer has incorrect keyboard responses, go to “Keyboard” on page 28.

(Step **003** continues)

003 (continued)

- If the printer has incorrect responses, go to “Printer” on page 28.
 - If the display has problems such as jittering, rolling, shifting, or being out of focus, go to “Display” on page 31.
-

Module test menu and hardware configuration report

Depending on the diagnostics version level you are using, the installed devices in the computer are verified in one of two ways:

1. At the start of the diagnostic tests, the Module Test Menu is displayed. Normally, all installed devices in the computer are highlighted on the menu.
2. At the start of the diagnostic tests, the main menu appears. From this menu, select **System Info** then select **Hardware Configuration** from the next menu. Normally, all installed devices in the computer are highlighted on this report.

If an installed device is not recognized by the diagnostics program:

- The diagnostic code for the device is not on the diagnostic diskette. Run the diagnostics provided with that device.
- The missing device is defective or it requires an additional diskette or service manual.
- An unrecognizable device is installed.
- A defective device is causing another device not to be recognized.
- The SCSI controller failed (on the system board or SCSI adapter).
- Use the procedure in "Undetermined problem" on page 104 to find the problem.

If a device is missing from the list, replace it. If this does not correct the problem, use the procedure in "Undetermined problem" on page 104.

Keyboard

Note

If a mouse or other pointing device is attached, remove it to see if the error symptom goes away. If the symptom goes away, the mouse or pointing device is defective.

001

- Power-off the computer.
 - Disconnect the keyboard cable from the system unit.
 - Power-on the computer and check the keyboard cable connector on the system unit for the voltages shown.
- All voltages are $\pm 5\%$.

Pin	Voltage (Vdc)
1	+5.0
2	Not Used
3	Ground
4	+5.0
5	+5.0
6	Not Used

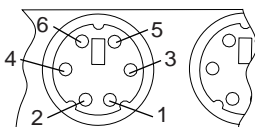

ARE THE VOLTAGES CORRECT?

Yes No

002

Replace the system board.

003

On keyboards with a detachable cable, replace the cable. If the problem remains or if the cable is permanently attached to the keyboard, replace the keyboard. If the problem remains, replace the system board.

Printer

1. Make sure the printer is properly connected and powered on.
2. Run the printer self-test.

If the printer self-test does not run correctly, the problem is in the printer. Refer to the printer service manual.

If the printer self-test runs correctly, install a wrap plug in the parallel port and run the diagnostic tests to determine which FRU failed.

If the diagnostic tests (with the wrap plug installed) do not detect a failure, replace the printer cable. If that does not correct the problem, replace the system board or adapter connected to the printer cable.

Power supply

If the power-on indicator is not on, the power-supply fan is not running, or the computer will not power-off, do the following.

Check/Verify	FRU/Action
1. Verify that the voltage-selector switch is set for the correct voltage.	Correct the voltage-selector switch setting.
2. Check the following for proper installation. <ul style="list-style-type: none">• Power Cord• On/Off Switch connector• On/Off Switch Power Supply connector• System Board Power Supply connectors• microprocessor(s) connection	Reseat
3. Check the power cord for proper continuity.	Power Cord
4. Check the power-on switch for continuity.	Power-on Switch

If the above are correct, check the following voltages.

20-pin main power supply connection

See “System board layout” on page 77 for connector location.

Attention

These voltages must be checked with the power supply cables connected to the system board.

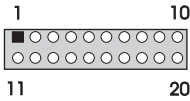

Pin	Signal	Function
1	3.3 V	+3.3 V dc
2	3.3 V	+3.3 V dc
3	COM	Ground
4	5 V	+5 V dc
5	COM	Ground
6	5 V	+5 V dc
7	COM	Ground
8	POK	Power Good
9	5VSB	Standby Voltage
10	12 V	+12 V dc
11	3.3 V	+3.3 V dc
12	-12 V	-12 V dc
13	COM	Ground
14	PS-ON	DC Remote Enable
15	COM	Ground
16	COM	Ground
17	COM	Ground
18	-5 V	-5 V dc
19	5 V	+5 V dc
20	5 V	+5 V dc

If the voltages are not correct, and the power cord is good, replace the power supply.

Display

If the screen is rolling, replace the display assembly. If that does not correct the problem, replace the video adapter (if installed) or replace the system board.

If the screen is not rolling, do the following to run the display self-test:

1. Power-off the computer and display.
2. Disconnect the display signal cable.
3. Power-on the display.
4. Turn the brightness and contrast controls clockwise to their maximum setting.
5. Check for the following conditions:
 - You should be able to vary the screen intensity by adjusting the contrast and brightness controls.
 - The screen should be white or light gray, with a black margin (test margin) on the screen.

Note

The location of the test margin varies with the type of display. The test margin might be on the top, bottom, or one or both sides.

If you do not see any test margin on the screen, replace the display. If there is a test margin on the screen, replace the video adapter (if installed) or replace the system board.

Note

During the first two or three seconds after the display is powered on, the following might occur while the display synchronizes with the computer.

- Unusual patterns or characters
- Static, crackling, or clicking sounds
- A “power-on hum” on larger displays

A noticeable odor might occur on new displays or displays recently removed from storage.

These sounds, display patterns, and odors are normal; do not replace any parts.

If you are unable to correct the problem, go to “Undetermined problem” on page 104.

Diagnostics and test information

The following tools are available to help identify and resolve hardware-related problems:

- Power-on self-test (POST)
- POST Beep Codes
- Error Code Format
- IBM PC Enhanced Diagnostics

Power-on self-test (POST)

Each time you power-on the system, it performs a series of tests that check the operation of the system and some options. This series of tests is called the *power-on self-test*, or *POST*. POST does the following:

- Checks some basic system-board operations
- Checks the memory operation
- Starts the video operation
- Verifies that the diskette drive is working
- Verifies that the hard disk drive is working

If the POST finishes without detecting any problems, a single beep sounds and the first screen of your operating system or application program appears.

Note

Type 6584/6594 computers default to come up quiet (No beep and no memory count and checkpoint code display) when no errors are detected by POST.

To enable Beep and memory count and checkpoint code display when a successful POST occurs:

1. Enable **Power on Status** in setup. See "Setup Utility program" on page 41.

If the POST detects a problem, an error message appears on your screen. A single problem can cause several error messages to appear. When you correct the cause of the first error message, the other error messages probably will not appear on the screen the next time you turn on the system.

POST beep codes

The Power On Self-Test generates a beeping sound to indicate successful completion of POST or to indicate that the tests detect an error.

One beep and the appearance of text on the display indicates successful completion of the POST. More than one beep indicates that the POST detects an error.

Note

Type 6584/6594 computers default to come up quiet (No beep and no memory count and checkpoint code display) when no errors are detected by POST.

To enable Beep and memory count and checkpoint code display when a successful POST occurs:

1. Enable **Power on Status** in setup. See "Setup Utility program" on page 41.

Error code format

This section provides an explanation of the encoded non-SCSI and SCSI POST error codes.

Error messages are displayed on the screen as three, four, five, eight, twelve, or thirteen digits. An "X" in an error message can be any number or letter. The shorter POST errors are highlighted in the Symptom-to-FRU Index. Some digits will represent different information for SCSI errors versus non-SCSI errors.

The following figure shows which digits display the shorter POST errors. The figure also defines additional SCSI information.

Notes

- Non-IBM device error codes and documentation supersede this list.
- Duplicate SCSI ID settings will cause misleading error symptoms or messages.

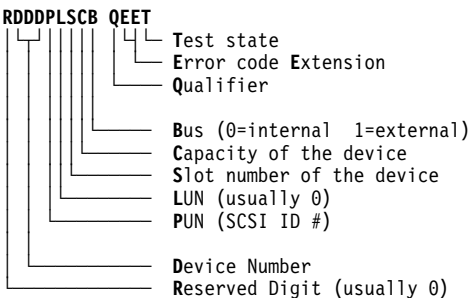

IBM PC Enhanced Diagnostics

The IBM PC Enhanced Diagnostics programs use a full range of diagnostic utilities to determine the operating condition of the computers hardware components. The user interface is WaterGate's PC-Doctor which serves as the control program for running the IBM PC Enhanced Memory Diagnostics and the suite of diagnostic tests provided by PC-Doctor.

The IBM PC Enhanced Diagnostics are available on-line and can be downloaded from:

<http://www.ibm.com/pc/us/>

- Select **Support**
- Select **IBM IntelliStation Support**
- Select **Downloadable Files**
- Select **Diagnostics**

This diagnostic diskette includes:

- A new user interface (WaterGate Software's PC-Doctor)
 - This interface serves as the control program for running both the IBM PC Enhanced Memory Diagnostics and the suite of diagnostic tests provided by PC-Doctor.
- IBM PC Enhanced Memory Diagnostics
 - The memory diagnostic tests determine which memory module (RIMM) is defective and report the socket where the failing module is located. The Memory diagnostics can run a quick and full test of the system. Diagnostics can also be run on a single RIMM.

Note

See "IBM PC Enhanced Diagnostics" for the IBM PC Enhanced Diagnostics error codes.

Starting the IBM PC Enhanced Diagnostics Program

To start the program:

1. Shut down and power-off the system.
2. Wait 10 seconds.
3. Insert the IBM PC Enhanced Diagnostics Diskette into diskette drive A.
4. Power-on the system.

The initial diagnostics menu will be displayed.

Navigating through the diagnostic programs

Use either the mouse or the keyboard to navigate through the Enhanced Diagnostics program.

- Use the cursor movement keys to navigate within the menus.
- The **Enter** key is used to select a menu item.
- The **Esc** key is used to back up to the previous menu.
- For online help select F1.

Running diagnostic tests

There are four ways to run the diagnostic tests:

1. Using the cursor movement keys, highlight **Run Normal Test** or **Run Quick Test** from the Diagnostics Menu and then press **Enter**.

This will automatically run a pre-defined group of tests from each test category. **Run Normal Test** runs a more extensive set of tests than does **Run Quick Test** and takes longer to execute.

2. Press **F5** to automatically run all selected tests in all categories. See "Test selection."
3. From within a test category, press **Ctrl-Enter** to automatically run only the selected tests in that category. See "Test selection."
4. Using the cursor movement keys, highlight a single test within a test category and then press **Enter**. This will run only that test.

Press **Esc** at any time to stop the testing process.

Test results, (N/A, PASSED, FAILED, ABORTED), are displayed in the field beside the test description and in the test log. See "Viewing the test log" on page 39.

Test selection

To select one or more tests:

1. Open the corresponding test category.
2. Using the cursor movement keys, highlight the desired test.
3. Press **Space bar**.

A selected test is marked with a chevron, >>.

Pressing the space bar again de-selects a test and removes the chevron.

4. Repeat steps 2 and 3 above to select all desired tests.

IBM PC Enhanced Memory Diagnostics

The IBM PC Enhanced Memory Diagnostics provide the capability to identify a particular memory module (RIMM) which fails during testing. Use the System Board Layout section to reference the memory sockets, or select **F1 twice** to load the Online Manual and select Chapter 11 'DIMM/RIMM Locator'.

Follow the steps below to locate the IBM PC Enhanced Memory Diagnostics test options.

1. Select the DIAGNOSTICS option on the toolbar and press **Enter**.
2. Highlight either the 'Memory Test-Full' or 'Memory Test-Quick' option and press **Enter**.
 - **Memory Test-Full**
The full memory test will take about 80 seconds per MB of memory and will detect marginal, intermittent, and solid (stuck) memory failures.
 - **Memory Test-Quick**
The quick memory test will take about 20 seconds per MB of memory and will detect solid (stuck) memory failures only.

Notes

Either level of memory testing can be performed on all memory or a single RIMM socket.

Only sockets containing a RIMM can be selected for testing. C-RIMM sockets are noted by besides the test description.

Alert On LAN test

The Alert On LAN test does the following:

- Determines if Alert On LAN is supported on the system.
- Checks the revision ID register.
- Verifies the EEPROM checksum.
- Validates that a software alert can be sent.

Asset ID test

The Asset ID test does the following:

- Determines if Asset ID is supported on the system.
- Verifies the EEPROM areas.
- Performs an antenna detection test.

Test results

IBM PC Enhanced Diagnostic test results will produce this error code format:

Function Code	Failure Type	DeviceID	Date	ChkDigits	Text
---------------	--------------	----------	------	-----------	------

Function Code: Represents the feature or function within the PC.

Failure Type: Represents the type of error encountered.

DeviceID: Contains the component's unit-id which corresponds to either a fixed disk drive, removable media drive, serial or parallel port, processor, specific RIMM, or a device on the PCI bus.

Date:	Contains the date on which the diagnostic test was run. Date is retrieved from CMOS and displayed using the YYYYMMDD format.
ChkDigits:	Contains a 2-digit check-digit value to ensure that: <ul style="list-style-type: none"> • Diagnostics were run on the specified date • Diagnostics were run on the specified IBM computer • The diagnostic error code is recorded correctly
Text:	Description of the error.

Note

See "IBM PC Enhanced Diagnostics error codes" on page 1 for error code listings.

Hard File Smart Test

Use the Hard File Smart Test when the system management tool has detected a hard file SMART alert.

The Smart Test does the following:

- Interrogates IDE devices for support of the SMART instruction set.
- Issues a ENABLE SMART command to make sure SMART functionality is active.
- Checks the SMART RETURN STATUS command to determine if any thresholds have been exceeded.

If thresholds have been exceeded, an error message is shown, and the test fails. If no SMART is supported by the drive, the test returns with N/A.

IBM Fixed Disk Optimized Test

The IBM Fixed Disk Optimized Test provide the capability to identify particular areas of a hard file which fails during testing. This test also provide a method of correcting certain types of errors.

To select the Fixed Disk Optimized Test:

1. Select the diagnostic option on the toolbar and press Enter.
2. Select the Fixed Disk Optimized Test
3. Select Hard Drives - NORMAL TEST to run a complete hard file test.
4. Select Hard Drives - PRESENCE TEST to run a test to check the drive controller and report any SMART information that the drive has detected.

Quick and Full erase - hard drive

The IBM PC Enhanced Diagnostics Program offers two hard drive format utilities:

- Quick Erase Hard Drive
- Full Erase Hard Drive

The Quick Erase Hard Drive provides a DOS utility that performs the following:

- Destroys the Master Boot Record (MBR) on the hard drive.
- Destroys all copies of the FAT Table on all partitions (both the master and backup).
- Destroys the partition table.
- Provides messages that warn the user that this is a non-recoverable process.

The Full Erase Hard Drive provides a DOS utility that performs the following:

- Performs all the steps in Quick Erase.
- Provides a DOS utility that writes random data to all sectors of the hard drive.
- Provide an estimate of time to completion along with a visual representation of completion status.
- Provides messages that warn the user that this is a non-recoverable process.

Important

Make sure customer backs up all data before using the Quick or Full Erase function.

To select the Quick Erase or Full Erase Hard Drive utility:

1. Select the UTILITY option on the toolbar and press enter.
2. Select either the QUICK ERASE or FULL ERASE HARD DISK option and then, follow the instructions.

Iomega Zip Drive Test

Use the Iomega Zip Drive Test to test the zip drive and the drive interface. The test takes about 20 seconds to run.

The default tests the following:

- Controller
- Max Seek (50 times)
- Random Seek (300 sectors)

Asset EEPROM backup

When replacing a system board, this utility allows the backup of all Asset information from the EEPROM to diskette. This utility also restores data to the EEPROM from diskette after replacement of the system board.

To run this utility:

- Select **Utility**
- Select **Asset EEPROM Backup**
- follow instructions on screen.

Viewing the test log

Errors reported by the diagnostic test will be displayed by the program as a failed test.

To view details of a failure or to view a list of test results, do the following from any test category screen:

- Press **F3** to activate the log File
- Press **F3** again to save the file to diskette or F2 to print the file.

RIMM memory errors: SIMM/DIMM/RIMM error messages issued by the IBM PC Enhanced Diagnostics:

Message	Failure Found	Recommended Actions
2xx-1y (for SIMMs)	A memory error was detected in SIMM socket Y	Replace the SIMM in the socket identified by the last digit of the error code. Re-run the test. If the same error code occurs again, replace the system board.
2xx-2y (for DIMMs/RIMMs)	A memory error was detected in DIMM/RIMM socket Y	Replace the DIMM/RIMM in the socket identified by the last digit of the error code. Re-run the test. If the same error code occurs again, replace the system board or where memory is on the processor card, replace the processor card.

Message	Failure Found	Recommended Actions
Corrupt BIOS	<p>Information in BIOS is not as expected.</p> <p>Not able to find expected DMI information from BIOS.</p> <p>Memory controller chipset vendor ID does not match expected value.</p>	<p>Reflash the BIOS.</p> <p>Perform boot block recovery.</p> <p>Replace the system board.</p>
Test aborted by user	User stopped test.	Restart test.
<p>Note:</p> <p>"Y" is the SIMM/DIMM/RIMM socket number. Use the System Board Layouts section in the latest Hardware Maintenance Manual, HMM, to reference the memory sockets.</p>		

Setup Utility program

Attention

A customized setup configuration (other than default settings) might exist on the computer you are servicing. Running the Setup Utility program might alter those settings. Note the current configuration settings and verify that the settings are in place when service is complete. To start the Setup Utility program, see "Setup Utility program."

The Setup Utility (configuration) program is stored in the permanent memory of the computer. This program includes settings for the following:

- System Summary
- Product Data
- Devices and I/O Ports
- Start Options
- Date and Time
- System Security
- Advanced Setup
- ISA Legacy Resources
- Power Management

To run the Setup Utility program, do the following:

1. Power-off the computer and wait for a few seconds until all in-use lights go off.
2. Power-on the computer.
3. When the Setup Utility prompt appears on the screen during start-up, press **F1**. The Setup Utility menu appears.
4. Follow the instructions on the screen.
5. When finished, select System Summary to verify that any configuration changes have been accepted.

Hard disk drive boot error

A hard disk drive boot error (error codes 1962 and I999030X) can be caused by the following:

Cause	Actions
The start-up drive is not in the boot sequence in configuration.	Check the configuration and ensure the start-up drive is in the boot sequence.
No operating system installed on the boot drive.	Install an operating system on the boot drive.

Cause	Actions
The boot sector on the start-up drive is corrupted.	The drive must be formatted, do the following: <ol style="list-style-type: none"> 1. Attempt to access and recover (back-up) the failing hard disk drive. 2. Using the operating systems programs, format the hard disk drive. 3. Go to "Preparing the hard disk drive for use" on page 42.
The drive is defective.	Replace the hard disk drive.

When to use the Low-Level Format program

Notes

1. The low-level format is not available on all diagnostic diskettes.
2. Before formatting the hard disk drive, make a back-up copy of the files on the drive to be formatted.

Use the Low-Level Format program:

- When you are installing software that requires a low-level format
- When you get recurring messages from the test programs directing you to run the Low-Level Format program on the hard disk
- As a last resort before replacing a hard disk drive

Preparing the hard disk drive for use

When the Low-Level Format program is finished, restore to the hard disk all the files that you previously backed up.

1. Partition the remainder of the hard disk for your operating system. (The commands vary with the operating system. Refer to your operating-system manual for instructions.)
2. Format the hard disk using your operating system. (The commands vary with the operating system. Refer to your operating-system manual for instructions.)
3. Install the operating system.

You are now ready to restore the files.

Product description

The PC 300 Type 6584/6594 computers are available in 4x5, (Four drive bays, Five I/O adapter slots which includes an AGP slot) as Type 6584 desktop and 6x7, (Six drive bays, Seven I/O adapter slots, which includes an AGP slot) as Type 6594 micro-tower models.

Note

Service information is the same for types 6584 and 6594 computers, unless specifically identified as type 6584 or 6594.

- Type 6584 is the desktop
- Type 6594 is the micro-tower

- **Security**
 - Administrator password
 - Cover lock
 - Power-on password
 - Operating system password
 - U-bolt and cable (Optional for some models)
- **CMOS backup battery (lithium)**
- **Common parts**

(Varies with each model, see “Type/Model configuration tables (6584/6594)” on page 106.)

 - Diskette drive
 - Hard disk drive
 - Keyboard
 - Power supply
 - Mouse

Specifications Information (ISO/ANSI)

The model specifications information on the following pages was determined in controlled acoustical environments according to procedures specified by the American National Standards Institute (ANSI) S12.10 and ISO 7779, and are reported in accordance with ISO 9296. Actual sound pressure levels in your location might differ from the average values stated because of room reflections and other nearby noise sources. The declared sound power levels indicate an upper limit, below which a large proportion of machines will operate.

Specifications Type 6584

Feature	Description
Size	Depth: 450 mm (17.7 inches) Height: 134 mm (5.3 inches) Width: 447 mm (17.6 inches)
Weight	Weight: 11.3 kg (25 lb) ¹
Environment	Air temperature: - System on: 10° to 35°C (50° to 95°F) - System off: 10° to 50°C (50° to 122°F) Humidity: - System on: 8% to 80% - System off: 8% to 80% Maximum altitude: 3048 m (10,000 ft)
Heat Output	Approximate heat output in BTUs per hour: - Minimum: 245 BTU (70 watts) - Maximum: 700 BTU (204 watts) ²
Electrical Input	Sine-wave input (47 to 63 Hz) required. Low range input voltage: - Minimum: 90 V ac - Maximum: 137 V ac High range input voltage: - Minimum: 180 V ac - Maximum: 265 V ac Input kVA (approximately): - Maximum (as shipped): 0.08 kVA
Airflow	Approximately 0.56 cubic meters/minute (20 CFM)
Acoustical Noise Emission Values	Average sound pressure levels: At operator position: - 41 dB operating - 34 dB idle At bystander position (1 meter): - 34 dB operating - 29 dB idle Declared (upper limit) sound power levels: - 5.0 bels operating - 4.5 bels idle

- 1 Maximum configuration weight depends on options installed. Figures above are a system fully populated with options.
- 2 Maximum power and heat specifications are based on the 145-watt maximum capacity of the system power supply.
- 3 For additional information, see the *ISO Supplier's Declaration* available from IBM.

Specifications Type 6594

Feature	Description
Size	Depth: 445 mm (17.5 inches) Height: 492 mm (19.4 inches) Width: 200 mm (7.9 inches)
Weight	Weight: 17.3 kg (38 lb) Fully configured ⁴
Environment	Air temperature: - System on: 10° to 35°C (50° to 95°F) - System off: 10° to 50°C (50° to 122°F) Humidity: - System on: 8% to 80% - System off: 8% to 80% Maximum altitude: 3048 m (10,000 ft)
Heat Output	Approximate heat output in BTUs per hour: - Minimum: 245 BTU (70 watts) - Maximum: 969 BTU (285 watts) ⁵
Electrical Input	Sine-wave input (47 to 63 Hz) required. Low range input voltage: - Minimum: 90 V ac - Maximum: 137 V ac High range input voltage: - Minimum: 180 V ac - Maximum: 265 V ac Input kVA (approximately): - Maximum (as shipped): 0.08 kVA
Airflow	Approximately 0.56 cubic meters/minute (20 CFM)
Acoustical Noise Emission Values	Average sound pressure levels: At operator position: - 35 dB operating - 33 dB idle At bystander position (1 meter): - 32 dB operating - 29 dB idle Declared (upper limit) sound power levels: - 4.8 bels operating - 4.5 bels idle

⁴ Maximum configuration weight depends on options installed. Figures above are a system fully populated with options.

⁵ Maximum power and heat specifications are based on the 200-watt maximum capacity of the system power supply.

⁶ For additional information, see the *ISO Supplier's Declaration* available from IBM.

Additional service information

The following additional service information supports the PC 300 types 6584/6594 computer.

- “Replacing a processor”
- “Replacing a system board” on page 47
- “Security features” on page 47
- “Passwords” on page 47
- “Vital Product Data” on page 49
- “Management Information Format (MIF)” on page 49
- “Alert on LAN2” on page 50
- “Hard disk drive jumper settings” on page 51
- “CD-ROM drive jumper settings” on page 52
- “BIOS levels” on page 53
- “Flash (BIOS/VPD) update procedure” on page 54
- “Flash recovery boot block” on page 54
- “Power management” on page 55
- “Network settings” on page 57
- “Flash over LAN (update POST/BIOS over network)” on page 57
- “Wake on LAN” on page 58
- “System board memory” on page 59

Replacing a processor

Make sure the processor is fully seated in its socket and that the goal post latches are engaged.

Important

- Make sure the air baffle is installed to prevent processor overheating.
- If the processor is not installed correctly, the system board and the processor can be damaged.

Replacing a system board

Notes

1. The BIOS and Vital Product Data (VPD) for the computer you are servicing must be installed on the new system board (FRU) after it is installed in the computer. To do this, **you must run the Flash Update program using the Flash Update diskette**. See “BIOS levels” on page 53 “Vital Product Data” on page 49, and “Flash (BIOS/VPD) update procedure” on page 54.
2. Always ensure the latest level of BIOS is installed on the computer. A down level BIOS may cause false errors and unnecessary replacement of the system board.
3. The processor is a separate FRU from the system board and is not included with the system board FRU. If you are instructed to replace the system board, do the following.
4. Remove the processor from the old system board and install it on the new system board.
5. Remove any of the following installed options on the old system board, and install them on the new system board.
 - Memory modules (RIMM and C-RIMM)
6. Ensure that the new system board jumper settings match the old system board jumper settings.
7. If the new system board does not correct the problem, reinstall the options on the old system board, reinstall the old system board, then replace the processor.

Security features

Security features in this section include:

- Passwords
- Vital Product Data
- Management Information Format (MIF)
- Alert on LAN2

Passwords

The following provides information about computer hardware and software-related passwords:

- Power-on Password
- Administrator Password
- Operating System Password

Power-on and Administrator passwords are set in the Setup Utility program. See “Setup Utility program” on page 41 for information about running the Setup Utility.

Power-on password: A power-on password denies access to the computer by an unauthorized user when the computer is powered on. When a power-on password is active, the password prompt appears on the screen each time the computer is powered on. The computer starts after the proper password is entered.

Removing a power-on password

To service a computer with an active and unknown power-on password, power-off the computer and do the following:

Note

On some models, this procedure will also remove the administrator password.

1. Unplug the power cord and remove the top cover.
2. Refer to "System board layout" on page 77 to find the recovery jumper.
3. Move the recovery jumper from 'normal' to 'clear'.
4. Power-on the computer. The system senses the change in the position and erases the password.
 - It is necessary to move the jumper back to the previous position.
5. Remind the user to enter a new password when service is complete.

Administrator password: The administrator password is used to restrict access to the Configuration/Setup Utility program. If the administrator password is activated, and you do not enter the administrator password, the configuration can be viewed but not changed.

Note

Type 6584/6594 has Enhanced Security Mode. If Enhanced Security mode is enabled and there is no password given, the computer will act as if Enhanced Security is disabled.

If Enhanced Security is Enabled and an administrator password is given, the administrator password must be entered to use the computer. If the administrator password is lost or forgotten, the system board in the computer must be replaced in order to regain access to the Configuration/Setup Utility program.

Administrator password control The Administrator password is set in the Setup Configuration. Refer to "Setup Utility program" on page 41

Operating system password: An operating system password is very similar to a power-on password and denies access to the computer by an unauthorized user when the password is activated. The computer is unusable until the password is entered and recognized by the computer.

Vital Product Data

Each computer has a unique Vital Product Data (VPD) code stored in the nonvolatile memory on the system board. After you replace the system board, the VPD must be updated. To update the VPD, see "Flash (BIOS/VPD) update procedure" on page 54.

Management Information Format (MIF)

Management Information Format (MIF) is a file used to maintain a list of the system unit serial number along with all serialized components; for example: system board, riser card, memory, and processor.

At the time of computer manufacture, the EPROM will be loaded with the serial numbers of the system and all major components. The customer will have access to the MIF file via the DMI MIF Browser that is installed with the preload and is also available on the SSCD provided with the system.

A company called Retain-a-Group is a central data warehouse offering serial number data management. Retain-a-Group acts as a focal point to law enforcement.

The customer has the option to purchase serial number information and services from Retain-a-Group. It is the customer's responsibility to maintain the MIF file and to inform Retain-a-Group of any changes to the file.

Some customers may request their servicers to assist them in maintaining the MIF file when serialized components are replaced during hardware service. This assistance is between the customer and the servicer. The servicer can use the DMI MIF Browser to update the MIF information in the EPROM. It is anticipated that some servicers might charge for this service.

To update the EPROM using the DMI MIF Browser:

1. Click **Start** from the desktop, then **Programs**.
2. Select **IBM SystemView™ Agent**.
3. Select **Serial Number Information** icon.
4. Click the plus sign to expand.
5. Select the component you want to view or edit.
6. Double click on the component you want to change.
7. Enter new data in the **Value** field, then click **Apply**.

Alert on LAN2

Alert on LAN2 provides notification of changes in the computer, even when the computer power is turned off. Working with DMI and Wake on LAN technologies, Alert on LAN2 helps to manage and monitor the hardware and software features of the computer. Alert on LAN2 generates notifications to the server of these occurrences:

- Computer disconnected from the network
- Computer unplugged from the power outlet
- All POST errors
- Operating system or POST hang condition

Alert on LAN2 events are configured to be Enabled or Disabled from the LAN server only, and not from the computer. See the LAN administrator for configuration status information.

Hard disk drive jumper settings

IDE hard disk drives for the PC 300 series computers use jumpers to set the drives as primary (master) or secondary (slave).

Attention

For drives not shown below, refer to the label on the hard disk drive for the hard disk drive settings.

IDE hard disk drive settings

- 1** Primary (Master) Hard Disk Drive
- 2** Secondary (Slave) Hard Disk Drive

IDE Drives

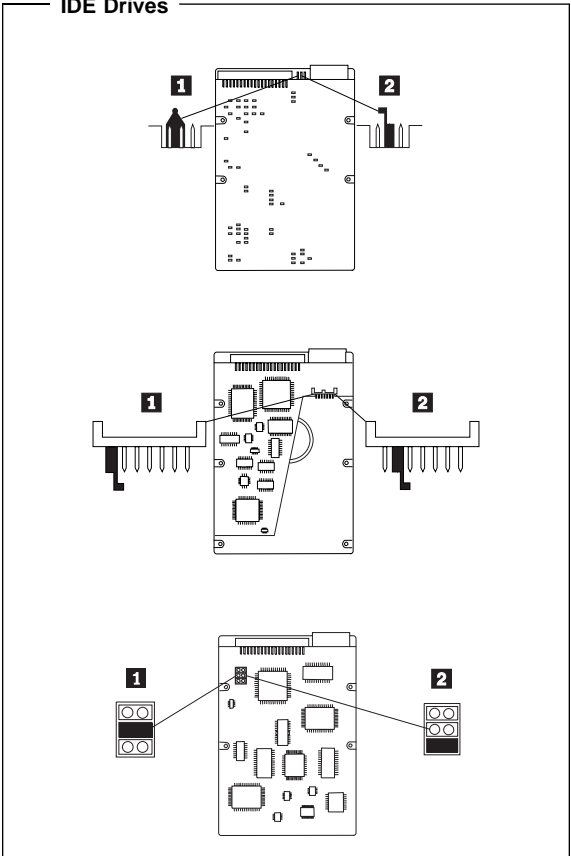

CD-ROM drive jumper settings

CD-ROM and PC/CD-ROM drives use jumpers or tabs to set the drives as primary (master) or secondary (slave). Refer to the drive connector labels or the figures below for the drive settings.

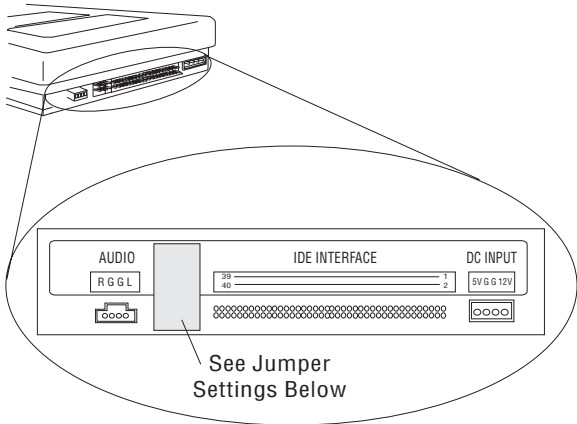

CD-ROM, PD/CD-ROM Type	Primary (Master)	Secondary (Slave)
2X CD-ROM FRU 06H5906	: : ■ : :	: ■ : : :
4X CD-ROM FRU 06H7654	: : ■ : :	: ■ : : :
6X CD-ROM	: : ■	: ■ :
8X CD-ROM	: : ■	: ■ :
6X PD/CD-ROM	: : ■	: ■ :
16X Max CD-ROM	: : ■	: ■ :
24X Max CD-ROM	: : ■	: ■ :
32X Max CD-ROM	: : ■	: ■ :
40X Max CD-ROM	: : ■	: ■ :
48X Max CD-ROM	: : ■	: ■ :

BIOS levels

An incorrect level of BIOS can cause false error and unnecessary FRU replacement. Use the following information to determine the current level of BIOS installed in the computer, the latest BIOS available for the computer, and where to obtain the latest level of BIOS.

- Current Level BIOS information.
 - Run the Configuration Utility to determine the level of BIOS installed.
- Sources for determining the latest level BIOS available.
 1. IBM PC Company Home Page
<http://www.ibm.com/pc/us/>
 2. PC PartnerInfo-Technical Database (CTSTIPS.NSF)
 3. Bulletin Board System (BBS)
 4. HelpCenter™
 5. Levels 1 and 2 Support
 6. RETAIN
- Sources for obtaining the latest level BIOS available.
 1. IBM PC Company Home Page
<http://www.ibm.com/pc/us/>
 2. PC PartnerInfo-Technical Database (CTSTIPS.NSF)
 3. Bulletin board system (BBS)
 4. HelpCenter
 5. Levels 1 and 2 Support

To update (flash) the BIOS, see “Flash (BIOS/VPD) update procedure” on page 54.

Flash (BIOS/VPD) update procedure

Attention

Refer to the information label located inside the system unit cover for any model-specific information.

1. Power-off the computer.
2. Insert the flash update diskette into drive A.
3. Power-on the computer.
4. When the Update Utility appears; select your country/keyboard, then press **Enter**.
5. If the computer serial number was previously recorded, the number is displayed with an option to update it. Press **Y** to update the serial number.
6. Type the 7-digit serial number of the computer you are servicing; then, press **Enter**.
7. Follow the instructions on the screen to complete the flash (BIOS/VPD) update procedure.

Flash recovery boot block

Attention

If an interruption occurs during a Flash/BIOS upgrade, the BIOS might be left in an unusable state. The Boot Block jumper enables you to restart the system and recover the BIOS.

To perform a Flash/BIOS recovery using the recovery jumper:

1. Power-off the computer and remove the cover.
2. Move the system board recovery jumper to the **clear** position. Refer to "System board layout" on page 77 or the information label inside the computer for more information.
3. Insert the upgrade diskette into the diskette drive.
4. Power-on the computer. The IBM Logo will appear.
5. When the Flash Update Utility appears; select your country/keyboard, then press **Enter**.
6. If the computer serial number was previously recorded, the number is displayed with an option to update it. Press **Y** to update the serial number.
7. Type the 7-digit serial number of the computer you are servicing; then, press **Enter**.
8. Follow the instructions on the screen to complete the flash (BIOS/VPD) update procedure.
9. When you are instructed to reboot the computer, power-off the computer and move the recovery jumper to the **normal** position. Then, replace the cover and power-on the computer.

Power management

Power management reduces the power consumption of certain components of the computer such as the system power supply, processor, hard disk drives, and some monitors. Advanced Power Management and Rapid Resume Manager are features of some personal computers.

Automatic configuration and power

interface (ACPI) BIOS: Being an ACPI BIOS system, the operating system is allowed to control the power management features of the computer and the setting for Advanced Power Management (APM) BIOS mode are ignored. Not all operating systems support ACPI BIOS mode.

Advanced Power Management: Energy-saving settings can be viewed and changed by using the Advanced Power Management menu in the Configuration/Setup Utility program.

Attention

If a device, such as a monitor, does not have power-management capabilities, it can be damaged when exposed to a reduced-power state. Before making energy-saving selections for the monitor, check the documentation supplied with the monitor to see if it supports Display Power Management Signaling (DPMS).

Automatic Hardware Power Management

features: Automatic Hardware Power Management can reduce the power states of the computer, processor, and monitor (if monitor supports DPMS) if they are inactive for a predetermined length of time.

There are three levels of specified time that the computer must be inactive before the power management options that are selected take effect. Select the amount of time that is offered within each level.

- Level 1** Set time from 5 minutes to 4 hours.
- Level 2** Set time from 10 minutes to 5 hours.
- Level 3** Set time from 15 minutes to 6 hours.

At each level, you can define the amount of energy savings by specifying values for the following options:

- **System Power:**
 - Select **On** for the computer to remain on.
 - Select **Off** for the computer to shut down.
- **Display:**

Set display to be disabled or to be reduced at these power states:

- **Standby:** Screen is blank, but can be restored immediately when any activity is detected.
- **Suspend:** Monitor uses less power than in Standby mode. Screen image is restored after a few seconds when any activity is detected.
- **Off:** Monitor power is off. Press Monitor power button to restore power. On some monitors, you might have to depress the power button twice.

Setting Automatic Hardware Power Management features

1. Start the Configuration/Setup Utility program (see “Setup Utility program” on page 41).
2. Select **Power Management** from the Configuration/Setup Utility program menu.
3. Select the **APM BIOS Mode** and be sure it is set to **Enabled**. If it is not, press Left Arrow (←) or Right Arrow (→) to change the setting.
4. Select **Automatic Hardware Power Management**.
5. Set **Automatic Hardware Power Management** to **Enabled**.
6. Select values for the two levels of power management (system power and display), as necessary.
7. Set **IDE Drives** to **Enabled** or **Disabled**.
Note: This does not apply to SCSI drives.
8. Select **Low Power Entry Activity Monitor** and enable or disable the listed options.
9. Select **Low Power Exit Activity Monitor** and enable or disable the listed options.
10. Press **Esc** twice to return to the Configuration/Setup Utility program menu.
11. Before you exit from the program, select **Save Settings** from the Configuration/Setup Utility program menu.
12. To exit from the Configuration/Setup Utility program, press **Esc** and follow the instructions on the screen.

Automatic Power-On features: The Automatic Power-On features within the Power Management menu allow you to enable and disable features that turn the computer on automatically.

- **Serial Port Ring Detect:** With this feature set to **Enabled** and an *external* modem connected to serial port (COM1), the computer will turn on automatically when a ring is detected on the modem.

- **Modem Ring Detect:** With this feature set to **Enabled**, the computer will turn on automatically when a ring is detected on the internal modem.
- **Wake Up on Alarm:** You can specify a date and time at which the computer will be turned on automatically. This can be either a single event or a daily event.
- **PCI Wake Up:** PCI Wake Up uses PCI Power Management Enabled (PME) to wake up the computer when using token-ring, Ethernet LAN adapters, modems, or other PCI cards capable of waking up the computer. When you set PCI Wake Up to **Enabled**, the computer will turn on when it receives a specific signal from another computer on when it receives a specific signal from another computer on the local area network (LAN) or from a modem signal.

Wake on LAN features can be used on the 6584 and 6594 computers. For further information, see “Wake on LAN” on page 58.

Network settings

This section applies only to computers linked to a network.

The Configuration/Setup Utility program includes settings that can be enabled and disabled to configure the network interface in the computer. These settings are:

- Flash over LAN (Update POST/BIOS over Network)
- Wake on LAN

Flash over LAN (update POST/BIOS over network)

Note: For local Flash (BIOS/VPD) update, see “Flash (BIOS/VPD) update procedure” on page 54.

This setting is used to enable or disable the Flash over LAN feature. When the feature is enabled, the system programs, in the computer, can be updated remotely from a network server. If the administrator password is set in the computer, it does not have to be entered by the server.

To access the Flash over LAN setting:

1. Start the Configuration/Setup Utility program. See “Setup Utility program” on page 41.
2. Select **System Security**.
3. Select **POST/BIOS Update** from the Configuration/Setup Utility program menu.
4. To enable Flash over LAN, select **Enabled**. To disable Flash over LAN, select **Disabled**.
5. Press **Esc** twice to return to the Configuration/Setup Utility program menu.

6. Before you exit from the program, select **Save Settings** from the Configuration/Setup Utility program menu.
7. To exit from the Configuration/Setup Utility program, press **Esc** and follow the instructions on the screen.

Wake on LAN

This setting is used to enable or disable the IBM-developed Wake on LAN feature. This feature makes it possible for the computer to be turned on remotely by a network server. Remote network management software must be used in conjunction with this feature.

To access the Wake on LAN setting:

1. Start the Configuration/Setup Utility program. See "Setup Utility program" on page 41.
2. Select **Advanced Power Management**.
3. Select **Automatic Power On** from the program menu.
4. Select **Wake on LAN** from the **Automatic Power On** menu.
5. To enable Wake on LAN, select **Enabled**. To disable Wake on LAN, select **Disabled**.
6. Press **Esc** until you return to the Configuration/Setup Utility program menu.
7. Before you exit from the program, select **Save Settings** from the Configuration/Setup Utility program menu.
8. To exit from the Configuration/Setup Utility program, press **Esc** and follow the instructions on the screen.

System board memory

The following matrix cross-references the name of the computer (printed on the logo) and the size, speed, and type of memory modules supported in the computer.

Note

RAMBUS inline memory module (RIMM) is used in the type 6584/6594 computer. RIMM modules are not compatible with SIMM or DIMM memory modules. Refer to the information below regarding RIMM memory for type 6584, 6594.

Computer Name	RIMM Memory Module		
	Size	Memory	Type
PC 300 Type 6584/ 6594	128 MB	PC700/ PC800	RDRAM ECC/ Non-ECC
	256 MB		
	512 MB Maximum	PC800 only	

Note

For maximum 512 MB configuration, two 256 MB PC800 memory RIMMs must be installed. PC700 memory RIMMs can not be used.

Supported RIMM memory configuration

Type 6584/6594 has two RIMM memory sockets. RIMM sockets must either have a RIMM memory module or a C-RIMM (RIMM Continuity module) installed. There can be no empty RIMM sockets. At least one socket must have a RIMM memory module installed.

- If new memory is to be added, remove a C-RIMM and install the new RIMM.
- If memory is to be removed, remove the RIMM and install a C-RIMM.

RIMM sizes of 128 MB and 256 MB are acceptable. RIMM sockets can be filled in any order. ECC or non-ECC, RAMBUS dynamic random access memory (RDRAM) are supported.

Note

Mixed RIMM speeds will run at the lower speed.

RIMM diagnostic approach

Identify any Beep or POST codes. See "Symptom-to-FRU index" on page 82.

Use the IBM PC Enhanced Diagnostics program to run memory tests. See "IBM PC Enhanced Diagnostics error codes" on page 1.

Procedures to determine memory errors:

1. If a memory error occurs, and the system is operational, run memory diagnostics.
2. If a memory error occurs, and the system is not operational:
 - a. Remove one RIMM module at a time until the system comes up.

Note

All unused RIMM sockets must have a C-RIMM installed.

- b. Run memory diagnostics.
- c. Install the other RIMM and run diagnostics again to identify the failing RIMM.

Computer exploded view (Type 6584)

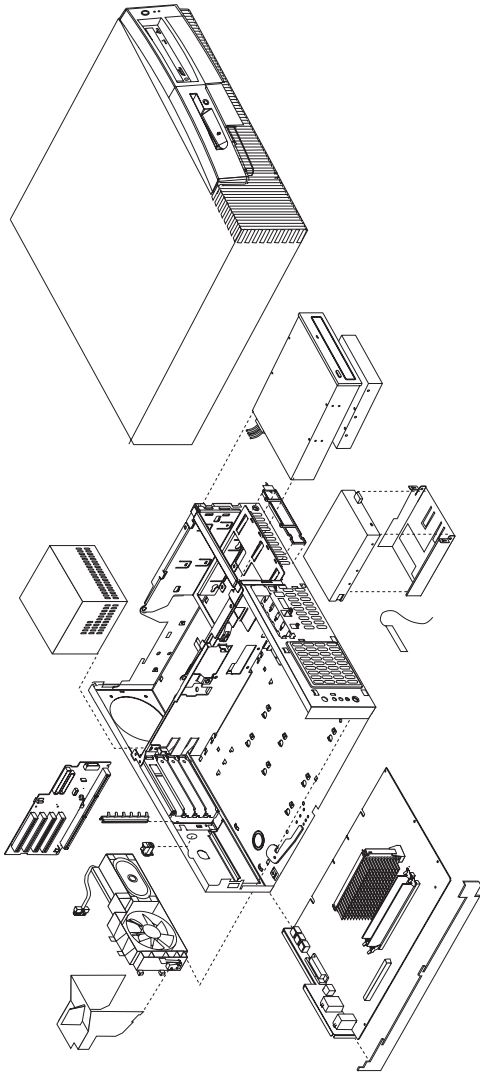

I/O connectors and removal procedures for the cover, CD-ROM/hard drive bracket, CD-ROM drive, hard drive, EIDE and SCSI cable routing, Diskette drive, system board, riser card, power supply, and fan/speaker bracket removal are on the following pages.

Input/Output connectors

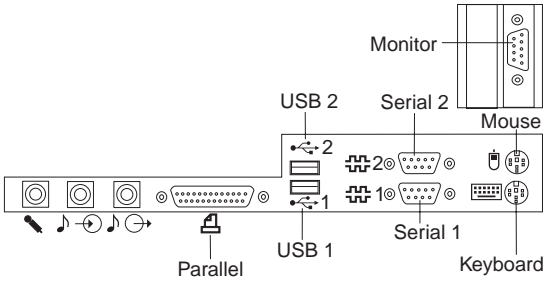

Top and front cover removal

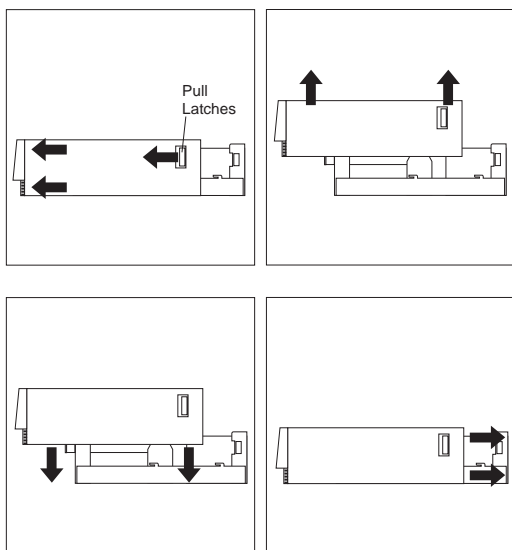

To remove top and front cover:

1. Pull left and right pull latches forward then pull cover forward.
2. Lift cover up from the chassis.

To install top and front cover:

1. Slide cover down onto the chassis about 4-inches (10.16 cm) from the rear of chassis.
2. Slide cover back to engage the left and right latches.

CD-ROM/hard drive bracket

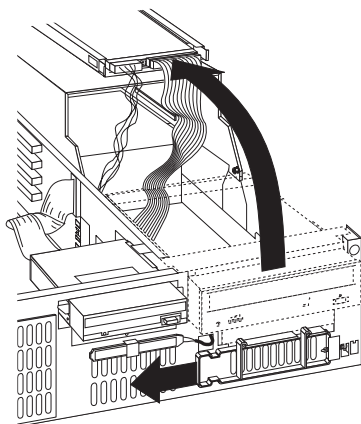

To open the CD-ROM/hard drive bracket:

1. Remove the top cover.
2. Slide the plastic spring loaded cage retainer to the left.
3. Lift the cage up and swing it back to the service position.

CD-ROM drive removal

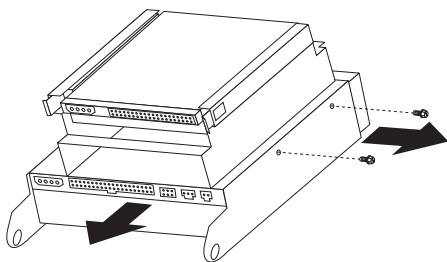

To remove the CD-ROM drive:

1. Remove the top cover.
2. Put the CD-ROM/hard drive bracket in its service position.
3. Disconnect the CD-ROM signal and power cables.
4. Remove two screws securing the CD-ROM drive.
5. Pull the CD-ROM drive out of the bracket.

Hard drive removal

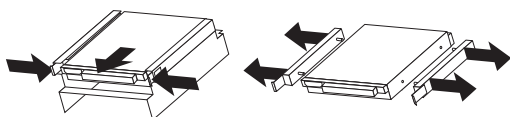

To remove the hard drive:

1. Remove the top cover.
2. Put the CD-ROM/hard drive bracket in its service position.
3. Disconnect the hard drive signal and power cables.
4. Push in on the left and right plastic tabs of the hard drive rails.
5. Pull the hard drive out of the bracket.

Note

Remove the plastic rails from the old hard drive and install them on the new hard drive.

EIDE cable routing

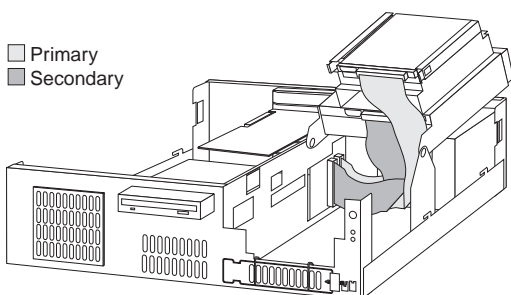

SCSI cable routing

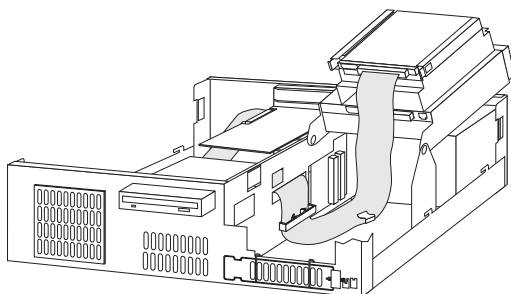

Diskette drive removal

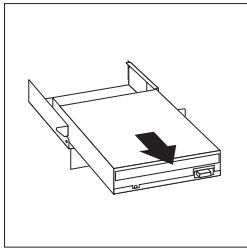
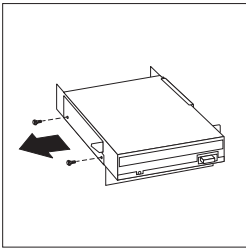
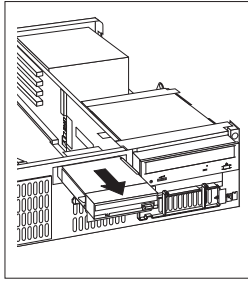
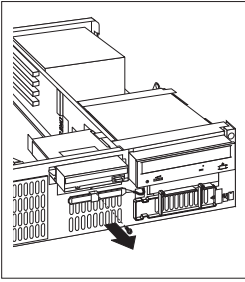

To remove the diskette drive:

1. Remove the top cover.
2. Disconnect the diskette drive signal and power cables.
3. Remove the front screw of the diskette drive cage.
4. Pull the diskette drive out of the chassis.
5. Remove the two side screws from the diskette drive cage.
6. Remove the diskette drive from its cage.

System board removal

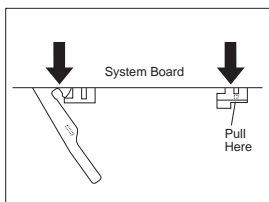
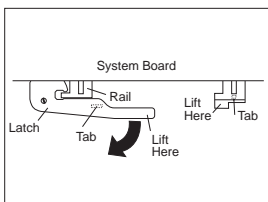
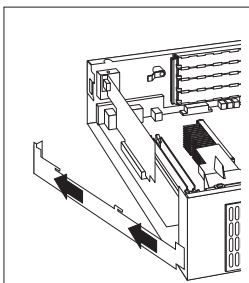
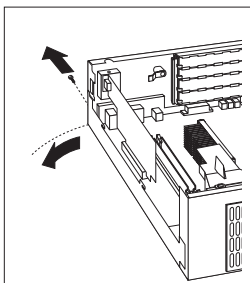

To remove the system board:

1. Remove the top cover.
2. Remove all cables connected to the system board.
3. Remove the AGP card, if installed.
4. Remove the retainer side bracket thumb screw.
5. Swing open the retainer side bracket and remove it from the chassis.
6. Lift up on the system board right-hand rail tab to disengage it from the bottom of the chassis.
7. Rotate the latch handle to disengage the system board.

System board installation

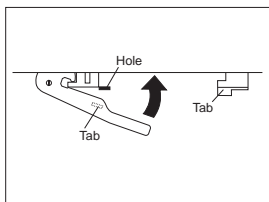
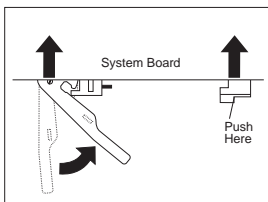

Rotate the latch handle and firmly push in on the end of the right-hand rail to engage the tab in the opening of the chassis.

Riser card removal

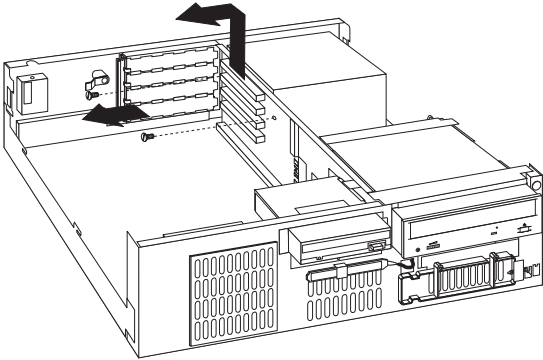

To remove the riser card:

1. Remove the top cover.
2. Remove the system board.
3. Disconnect all cables from the front and back of the riser card.
4. Remove the two top screws securing the riser card.
5. Remove the riser card from the chassis.

Power supply removal

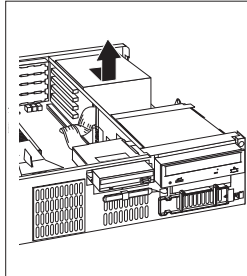
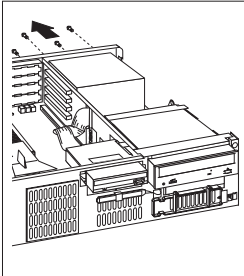

Note

1. Make sure the power supply voltage switch is set to the proper operating voltage; 115V or 230V.

To remove the power supply:

1. Remove the top cover.
2. Disconnect the power supply connectors.
3. Remove the four screws securing the power supply to the chassis.
4. Move power supply inward, then lift out of the chassis.

Fan and speaker bracket removal

Note

1. If you remove the LED/power cable or the RFID antenna cable, make sure it is routed the same way it was installed.
2. When removing the C2 switch assembly from the fan bracket, use care to pry the switch (alternating at both ends of the switch) from its mounting studs.
3. Make sure the RFID antenna cable is grounded to the chassis by its grounding lug.

To remove the fan bracket:

1. Remove the top cover.
2. Remove the air duct.
3. Disconnect the fan and speaker connectors.
4. Push on the outside tab to release the bracket from the chassis.
5. Swing the bracket inward and then pull it from the chassis.

Computer exploded view (Type 6594)

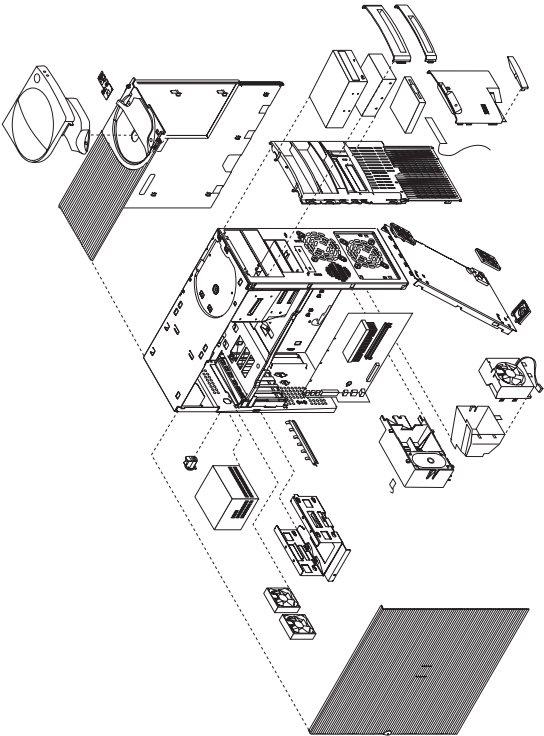

I/O connectors and removal procedures for the access cover, top handle cover, system board, hard disk drive, tab, and fan cage, air baffle, and card guide are on the following pages.

Input/Output connectors

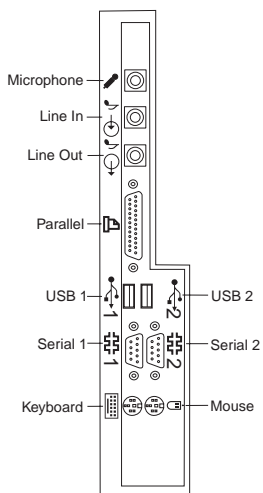

Access cover removal

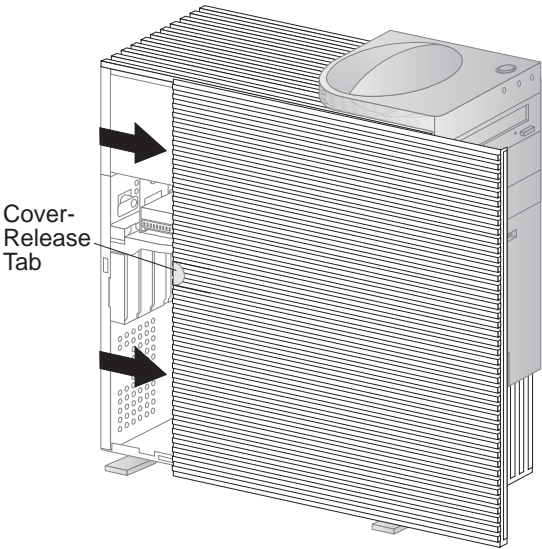

Unlock cover from back of the system unit before removing cover.

Top handle cover removal

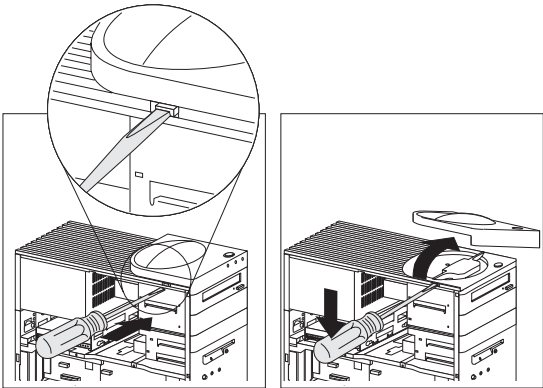

Attention

Do not lift handle cover too high or the tabs will break.

Front bezel removal/replacement

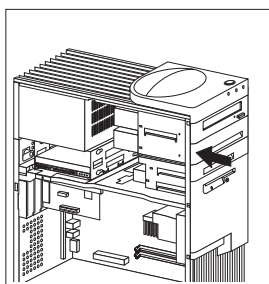
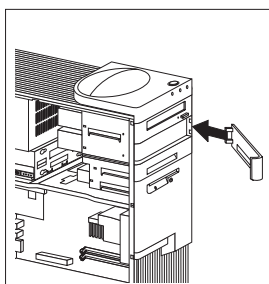
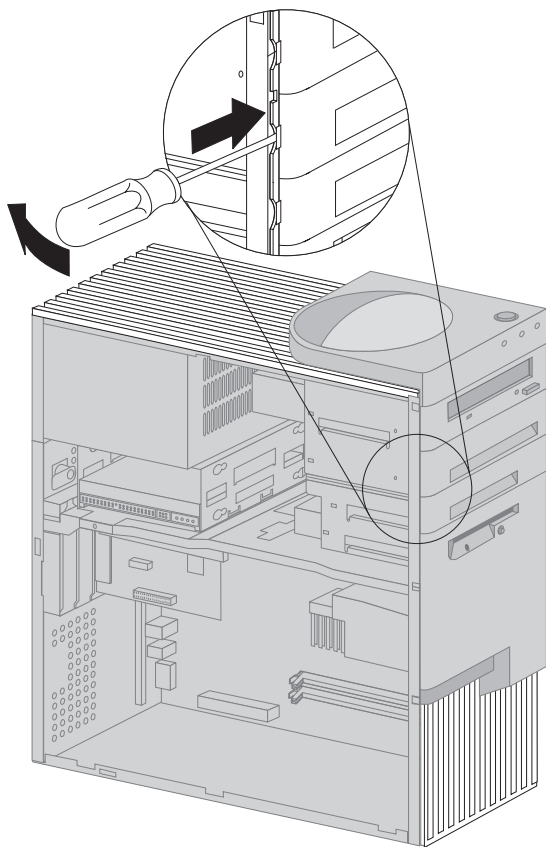

System board removal

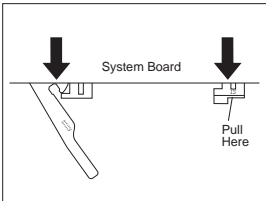
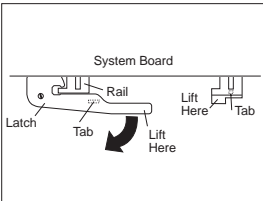
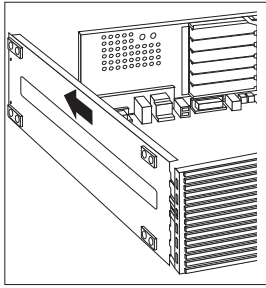
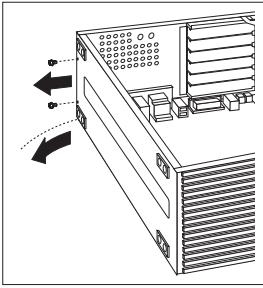

System board installation

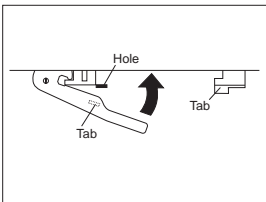
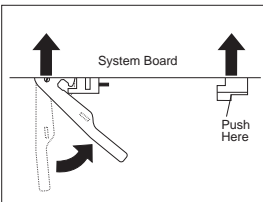

Hard disk bracket removal

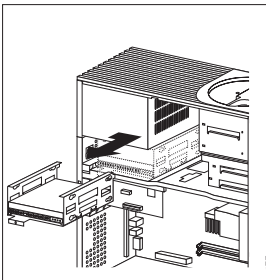
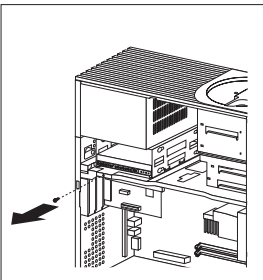

Hard disk drive in non removable drive cage

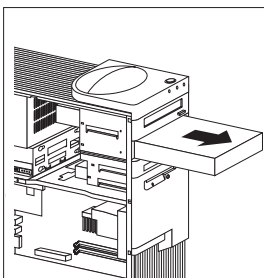
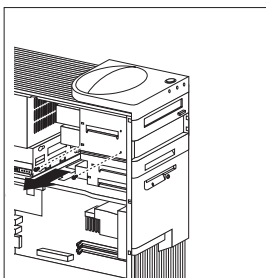

Tab removal

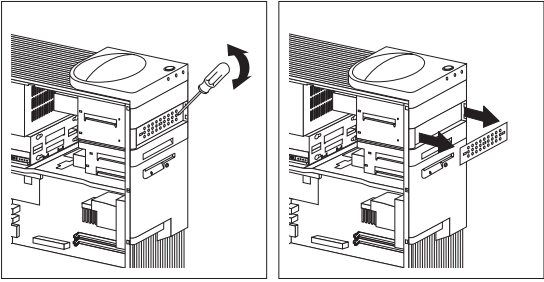

Fan cage, air baffle, speaker/card guide removal

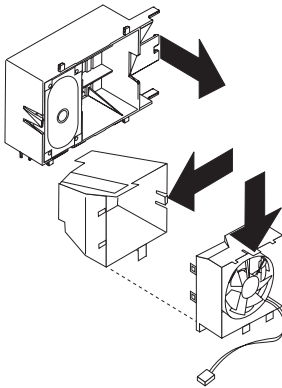

Push in on the latches as shown by arrows to release the fan cage, air baffle, or speaker/card guide.

Note

After releasing the latch on the speaker/card guide, slide it away from the latch to disengage it from the chassis.

System board layout

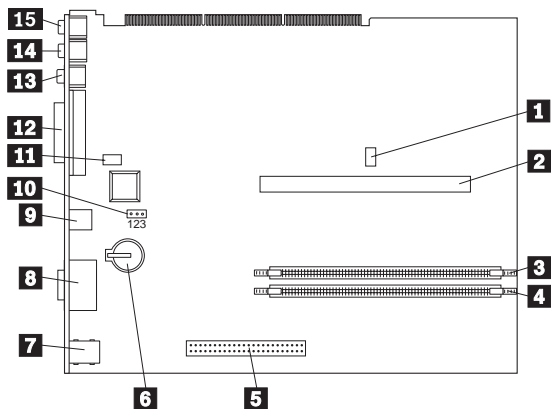

System board locations

- | | |
|-----------|------------------------------------|
| 1 | Processor fan connector (not used) |
| 2 | Processor socket |
| 3 | RIMM socket 1 |
| 4 | RIMM socket 2 |
| 5 | AGP connector |
| 6 | Battery |
| 7 | Keyboard/Mouse connectors |
| 8 | Serial 1,2 connectors |
| 9 | USB connectors |
| 10 | Recovery jumper |
| 11 | PC PCI connector (not used) |
| 12 | Parallel connector |
| 13 | Line Out connector |
| 14 | Line In connector |
| 15 | Microphone connector |

System board jumper settings

The following table contains the jumper setting information. (D) indicates the default setting.

Clear CMOS/Flash Boot Block Recovery

Use the recovery jumper setting to Clear CMOS or to Flash Boot Block Recover.

Jumper	Setting	Description
Recovery	2-3 (clear)	Clear CMOS/ Flash Recovery Mode
	1-2 (D) (normal)	Normal Mode

Processor Speed Settings

Processor speed for the PC 300 type 6584/6594 computers are fixed and are determined by the processor. There are no settings required.

Diskette Write Access

Diskette Write Enable and Write Protect options are changed in the Setup Configuration. See "Setup Utility program" on page 41.

Riser cards (Type 6584)

Riser card, ISA/PCI, front view

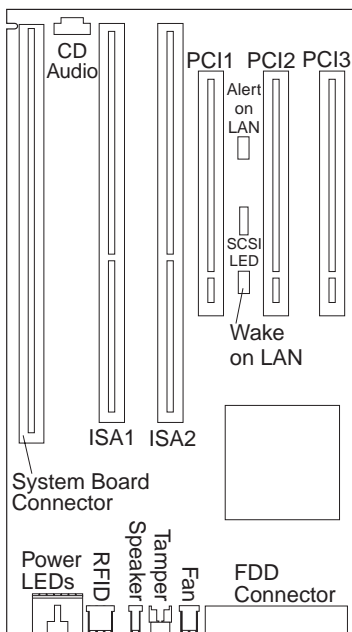

Riser card, PCI, front view

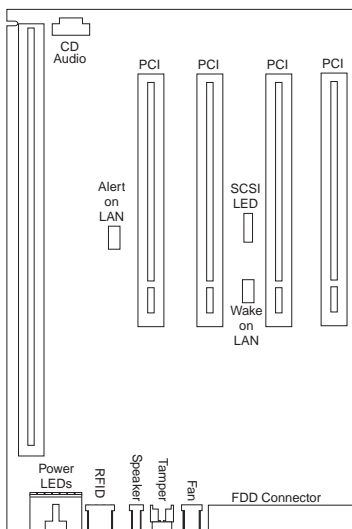

Riser card, back view (both cards)

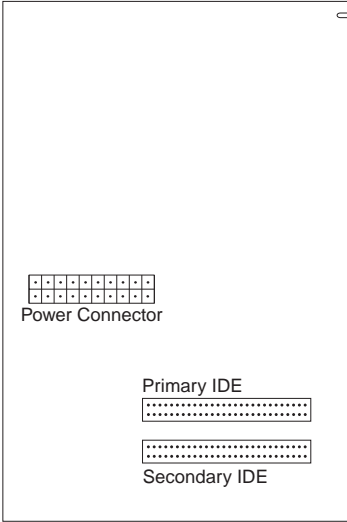

Riser card (Type 6594)

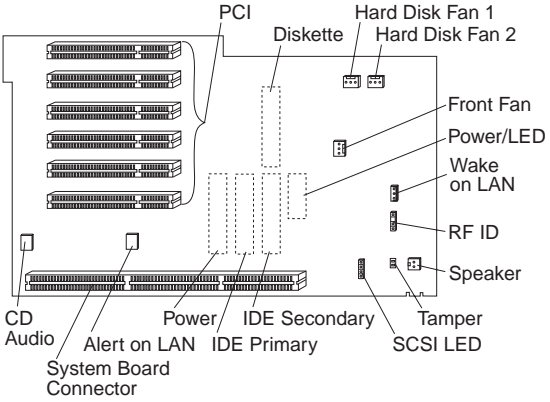

Symptom-to-FRU index

The Symptom-to-FRU index lists error symptoms and possible causes. The most likely cause is listed first. Always begin with "General checkout" on page 24. See "IBM PC Enhanced Diagnostics error codes" on page 1 when running diagnostics. This index can also be used to help you decide which FRUs to have available when servicing a computer. If you are unable to correct the problem using this index, go to "Undetermined problem" on page 104.

Notes

- If you have both an error message and an incorrect audio response, diagnose the error message first.
- If you cannot run the diagnostic tests or you get a diagnostic error code when running a test, but did receive a POST error message, diagnose the POST error message first.
- If you did not receive any error message, look for a description of your error symptoms in the first part of this index.
- Check all power supply voltages before you replace the system board. (See "Power supply" on page 29.)
- Check the hard disk drive jumper settings before you replace a hard disk drive. (See "Hard disk drive jumper settings" on page 51.)

Important

1. Some errors are indicated with a series of beep codes. (See "Beep symptoms" on page 83.)
Type 6584/6594 computers default to come up quiet (No beep and no memory count and checkpoint code display) when no errors are detected by POST. To enable Beep and memory count and checkpoint code display when a successful POST occurs:
 - Enable **Power on Status** in setup. See "Setup Utility program" on page 41.
2. The processor is a separate FRU from the system board; the processor is not included with the system board FRU.

Beep symptoms

Beep symptoms are short tones or a series of short tones separated by pauses (intervals without sound). See the following examples.

Beeps	Description
1-2-X	<ul style="list-style-type: none"> • One Beep • A pause (or break) • Two beeps • A pause (or break) • Any number of beeps
4	Four continuous beeps

Beep Symptom	FRU/Action
1-1-3 CMOS read/write error	<ol style="list-style-type: none"> 1. Run Setup 2. System Board
1-1-4 ROM BIOS check error	<ol style="list-style-type: none"> 1. System Board
1-2-X DMA error	<ol style="list-style-type: none"> 1. System Board
1-3-X	<ol style="list-style-type: none"> 1. RIMM Memory Module see "System board memory" on page 59 2. C-RIMM 3. System Board
1-4-4	<ol style="list-style-type: none"> 1. Keyboard 2. System Board
1-4-X Error detected in first 64 KB of RAM.	<ol style="list-style-type: none"> 1. Memory Module 2. System Board
2-1-1, 2-1-2	<ol style="list-style-type: none"> 1. Run Setup 2. System Board
2-1-X First 64 KB of RAM failed.	<ol style="list-style-type: none"> 1. Memory Module 2. System Board
2-2-2	<ol style="list-style-type: none"> 1. Video Adapter (if installed) 2. System Board
2-2-X First 64 KB of RAM failed.	<ol style="list-style-type: none"> 1. Memory Module 2. System Board
2-3-X	<ol style="list-style-type: none"> 1. Memory Module 2. System Board
2-4-X	<ol style="list-style-type: none"> 1. Run Setup 2. Memory Module 3. System Board
3-1-X DMA register failed.	<ol style="list-style-type: none"> 1. System Board
3-2-4 Keyboard controller failed.	<ol style="list-style-type: none"> 1. System Board 2. Keyboard

Beep Symptom	FRU/Action
3-3-4 Screen initialization failed.	<ol style="list-style-type: none"> Video Adapter (if installed) System Board Display
3-4-1 Screen retrace test detected an error.	<ol style="list-style-type: none"> Video Adapter (if installed) System Board Display
3-4-2 POST is searching for video ROM.	<ol style="list-style-type: none"> Video Adapter (if installed) System Board
4	<ol style="list-style-type: none"> Video Adapter (if installed) System Board
All other beep code sequences.	<ol style="list-style-type: none"> System Board
One long and one short beep during POST. Base 640 KB memory error or shadow RAM error.	<ol style="list-style-type: none"> Memory Module System Board
One long beep and two or three short beeps during POST. (Video error)	<ol style="list-style-type: none"> Video Adapter (if installed) System Board
Three short beeps during POST.	<ol style="list-style-type: none"> See "System board memory" on page 59. System Board
Continuous beep.	<ol style="list-style-type: none"> System Board
Repeating short beeps.	<ol style="list-style-type: none"> Keyboard stuck key? Keyboard Cable System Board

No beep symptoms

Note

Type 6584/6594 computers default to come up quiet (No beep and no memory count and checkpoint code display) when no errors are detected by POST.

To enable Beep and memory count and checkpoint code display when a successful POST occurs:

- Enable **Power on Status** in setup. See "Setup Utility program" on page 41.

Symptom/Error	FRU/Action
No beep during POST but computer works correctly.	<ol style="list-style-type: none"> System Board

Symptom/Error	FRU/Action
No beep during POST.	<ol style="list-style-type: none">1. See “Undetermined problem” on page 104.2. System Board3. Memory Module4. Any Adapter or Device5. Riser Card6. Power Cord7. Power Supply

POST error codes

In the following index, "X" can represent any number.

POST Error Code	FRU/Action
000 SCSI Adapter not enabled.	1. Verify adapter device and Bus Master fields are enabled in PCI configuration program. See documentation shipped with computer.
02X	1. SCSI Adapter
08X Check SCSI terminator installation.	1. SCSI Cable 2. SCSI Terminator 3. SCSI Device 4. SCSI Adapter
101 System board interrupt failure.	1. System Board
102 System board timer error.	1. System Board
106	1. System Board
110 System board memory parity error.	1. Memory Module 2. System Board
111 I/O channel parity error.	1. Reseat adapters 2. Any Adapter 3. Riser card 4. System Board
114 Adapter ROM error.	1. Adapter Memory 2. System Board 3. Riser card
129 Internal cache test error.	1. Processor 2. L2 Cache Memory 3. System Board
151 Real-time clock failure.	1. System Board
161 Bad CMOS battery.	1. Run Setup 2. CMOS Backup Battery (See page "Safety information" on page 226.) 3. System Board

POST Error Code	FRU/Action
<p>162 Configuration mismatch.</p>	<ol style="list-style-type: none"> 1. Run Setup and verify Configuration 2. Had a device been added, removed, changed location? If not, suspect that device. 3. Power-on external devices first, then power-on computer. 4. CMOS Backup Battery (See page "Safety information" on page 226.) 5. System Board 6. Riser card
<p>162 And unable to run diagnostics.</p>	<ol style="list-style-type: none"> 1. Diskette Drive 2. System Board 3. Diskette Drive Cable 4. Riser card
<p>163 Clock not updating or invalid time set.</p>	<ol style="list-style-type: none"> 1. Time and Date Set? 2. CMOS Backup Battery (See page "Safety information" on page 226.) 3. System Board
<p>164 POST detected a base memory or extended memory size mismatch error. or RIMM socket 3 is populated with a RIMM memory module.</p>	<ol style="list-style-type: none"> 1. Run Setup. Check System Summary menu for memory size change. (See "Setup Utility program" on page 41.) 2. Run the Extended Memory Diagnostic tests. 3. Replace RIMM memory module in socket 3 with a C-RIMM
<p>166 Boot Block Check Sum Error</p>	<ol style="list-style-type: none"> 1. Run Flash Recovery using Boot Block. See "Flash recovery boot block" on page 54 2. System Board
<p>167 Microprocessor installed that is not supported by the current POST/BIOS.</p>	<ol style="list-style-type: none"> 1. Run Setup. Check Stepping level for the BIOS level needed, then perform the flash update. 2. Processor

POST Error Code	FRU/Action
168 Alert on LAN2 error	<ol style="list-style-type: none"> 1. Run Setup. Check to see that Ethernet and Alert on LAN2 are enabled. 2. System Board 3. Riser card
17X, 18X	1. C2 Security
175	<ol style="list-style-type: none"> 1. Run Configuration (See "Setup Utility program" on page 41.) 2. System Board
176	1. Covers were removed from the computer.
177 Corrupted Administrator Password.	1. System Board
178	1. System Board
183	1. Enter the administrator password
184 No RFID Antenna	<ol style="list-style-type: none"> 1. Make sure Asset Care and Asset ID™ are enabled in Configuration/Setup. 2. RFID Antenna 3. System Board 4. Riser card
185 Corrupted boot sequence.	1. Set configuration and reinstall the boot sequence.
186	1. System Board
187	<ol style="list-style-type: none"> 1. Clear Administration password 2. System Board
189	1. More than three password attempts were made to access the computer.
190 Chassis intrusion detector was cleared. This is information only, no action required. If this code does not clear:	1. System Board
1XX Not listed above.	1. System Board
201, 20X Memory data error.	<ol style="list-style-type: none"> 1. Run Enhanced Diag. Memory Test 2. Memory Module 3. System Board
225	1. Unsupported Memory

POST Error Code	FRU/Action
229 External cache test error.	<ol style="list-style-type: none"> 1. L2 Cache Memory 2. System Board
262 POST detected a base memory or extended memory type error.	<ol style="list-style-type: none"> 1. Run Setup. Check System Summary menu for memory type change. (See "Setup Utility program" on page 41.) 2. Run the Extended Memory Diagnostic tests.
301	<ol style="list-style-type: none"> 1. Keyboard 2. Keyboard Cable 3. System Board
303 With an 8603 error.	<ol style="list-style-type: none"> 1. Mouse 2. Keyboard 3. Keyboard Cable 4. System Board
303 With no 8603 error.	<ol style="list-style-type: none"> 1. Keyboard 2. Keyboard Cable 3. System Board
3XX Not listed above.	<ol style="list-style-type: none"> 1. Keyboard 2. Keyboard Cable 3. System Board
5XX	<ol style="list-style-type: none"> 1. Video Adapter (if installed) 2. System Board
601	<ol style="list-style-type: none"> 1. Diskette Drive A 2. Diskette Drive Cable 3. System Board 4. Riser card
602	<ol style="list-style-type: none"> 1. Bad Diskette ? 2. Verify Diskette and retry.
604 And able to run diagnostics.	<ol style="list-style-type: none"> 1. Run Setup and verify diskette configuration settings 2. Diskette Drive A/B 3. Diskette Drive Cable 4. System Board 5. Riser card
605 POST cannot unlock the diskette drive.	<ol style="list-style-type: none"> 1. Diskette Drive 2. Diskette Drive Cable 3. System Board 4. Riser card
662	<ol style="list-style-type: none"> 1. Diskette drive configuration error or wrong diskette drive type, run Setup Configuration.

POST Error Code	FRU/Action
6XX Not listed above.	<ol style="list-style-type: none"> 1. Diskette Drive 2. System Board 3. Riser card 4. External Drive Adapter 5. Diskette Drive Cable 6. Power Supply
762 Math coprocessor configuration error.	<ol style="list-style-type: none"> 1. Run Setup 2. Processor 3. System Board
7XX Not listed above.	<ol style="list-style-type: none"> 1. Processor 2. System Board
962 Parallel port configuration error.	<ol style="list-style-type: none"> 1. Run Configuration 2. Parallel Adapter (if installed) 3. System Board
9XX	<ol style="list-style-type: none"> 1. Printer 2. System Board
1047	<ol style="list-style-type: none"> 1. 16-Bit AT Fast SCSI Adapter
107X Check SCSI terminator installation.	<ol style="list-style-type: none"> 1. Check SCSI terminator installation. 2. SCSI Cable 3. SCSI Terminator 4. SCSI Device 5. SCSI Adapter
1101 Serial connector error, possible system board failure.	<ol style="list-style-type: none"> 1. Run Enhanced Diagnostics
1101, 1102, 1106, 1108, 1109	<ol style="list-style-type: none"> 1. System Board 2. Any Serial Device
1107	<ol style="list-style-type: none"> 1. Communications Cable 2. System Board
1102 Card selected feedback error.	<ol style="list-style-type: none"> 1. Run Enhanced Diagnostics
1103 Port fails register check.	<ol style="list-style-type: none"> 1. Run Enhanced Diagnostics 2. System Board
1106 Serial option cannot be turned off.	<ol style="list-style-type: none"> 1. Run Enhanced Diagnostics 2. System Board
1107	<ol style="list-style-type: none"> 1. Serial Device Cable 2. System Board
1110 Register test failed.	<ol style="list-style-type: none"> 1. Run Enhanced Diagnostics 2. System Board
1116 Interrupt error.	<ol style="list-style-type: none"> 1. Run Enhanced Diagnostics

POST Error Code	FRU/Action
1117 Failed baud rate test.	1. Run Enhanced Diagnostics
1162 Serial port configuration error.	1. Run Configuration 2. Serial Adapter (if installed) 3. System Board
11XX Not listed above.	1. System Board
1201	1. System Board 2. Any Serial Device
1202, 1206, 1208, 1209, 12XX	1. Dual Async Adapter/A 2. System Board 3. Any Serial Device
1207	1. Communications Cable 2. Dual Async Adapter/A
13XX	1. Game Adapter
1402 Printer not ready.	Information only
1403 No paper error, or interrupt failure.	Information only
1404 System board timeout failure.	1. Run Enhanced Diagnostics
1405 Parallel adapter error.	1. Run Enhanced Diagnostics
1406 Presence test error.	1. Run Enhanced Diagnostics
14XX Not listed above. Check printer before replacing system board.	1. Printer 2. System Board
15XX	1. SDLC Adapter
1692 Boot sequence error.	1. Run FDISK to ensure at least one active partition is set active.
16XX	1. 36/38 Workstation Adapter
1762 Hard disk drive configuration error.	1. Run Configuration (See "Setup Utility program" on page 41.)
1780 (Disk Drive 0) 1781 (Disk Drive 1) 1782 (Disk Drive 2) 1783 (Disk Drive 3)	1. See "Power supply" on page 29. 2. Hard Disk Drive 3. System Board 4. Riser card 5. Hard Disk Cable 6. Power Supply

POST Error Code	FRU/Action
180X, 188X PCI configuration or resource error.	<ol style="list-style-type: none"> 1. Run Setup and verify PCI/ISA configuration settings. 2. If necessary, set ISA adapters to "Not available" to allow PCI adapters to properly configure. 3. Remove any suspect ISA adapters. 4. Rerun diagnostics. 5. PCI Adapter
1962 Boot sequence error.	<ol style="list-style-type: none"> 1. Possible hard disk drive problem, see "Hard disk drive boot error" on page 41.
209X	<ol style="list-style-type: none"> 1. Diskette Drive 2. Diskette Cable 3. 16-bit AT Fast SCSI Adapter
20XX Not listed above	<ol style="list-style-type: none"> 1. BSC Adapter
21XX	<ol style="list-style-type: none"> 1. SCSI Device 2. 16-bit AT Fast SCSI Adapter 3. Alternate BSC Adapter
2401, 2402 If screen colors change.	<ol style="list-style-type: none"> 1. Display
2401, 2402 If screen colors are OK.	<ol style="list-style-type: none"> 1. System Board 2. Display
2409	<ol style="list-style-type: none"> 1. Display
2410	<ol style="list-style-type: none"> 1. System Board 2. Display
2462 Video memory configuration error.	<ol style="list-style-type: none"> 1. Check cable connections. 2. Run Setup and verify video configuration settings. 3. Video Memory Modules 4. Video Adapter (if installed) 5. System Board
3015, 3040 Check for missing wrap or terminator plug on the adapter.	<ol style="list-style-type: none"> 1. Network Attached? 2. LF Translator 3. Cable Problem 4. PC Network Adapter
30XX	<ol style="list-style-type: none"> 1. PC Network Adapter 2. LF Translator 3. Cable Problem?

POST Error Code	FRU/Action
3115, 3140	<ol style="list-style-type: none"> 1. Network Attached? 2. LF Translator 3. Alternate PC Network-Adapter 4. Cable Problem
31XX	<ol style="list-style-type: none"> 1. Alternate PC Network Adapter 2. LF Translator 3. Cable Problem
36XX	<ol style="list-style-type: none"> 1. GPIB Adapter
38XX	<ol style="list-style-type: none"> 1. DAC Adapter
4611, 4630	<ol style="list-style-type: none"> 1. Multiport/2 Interface Board 2. Multiport/2 Adapter
4612, 4613 4640, 4641	<ol style="list-style-type: none"> 1. Memory Module Package 2. Multiport/2 Adapter
4650	<ol style="list-style-type: none"> 1. Multiport/2 Interface Cable
46XX Not listed above.	<ol style="list-style-type: none"> 1. Multiport/2 Adapter 2. Multiport/2 Interface Board 3. Memory Module
5600	<ol style="list-style-type: none"> 1. Financial System Controller Adapter
5962 An IDE device (other than hard drive) configuration error.	<ol style="list-style-type: none"> 1. Run Configuration 2. CD-ROM Drive 3. CD-ROM Adapter 4. ZIP or other ATAPI device 5. System Board 6. Riser card
62XX	<ol style="list-style-type: none"> 1. 1st Store Loop Adapter 2. Adapter Cable
63XX	<ol style="list-style-type: none"> 1. 2nd Store Loop Adapter 2. Adapter Cable
64XX	<ol style="list-style-type: none"> 1. Network Adapter
71XX	<ol style="list-style-type: none"> 1. Voice Adapter
74XX	<ol style="list-style-type: none"> 1. Video Adapter (if installed)
76XX	<ol style="list-style-type: none"> 1. Page Printer Adapter
78XX	<ol style="list-style-type: none"> 1. High Speed Adapter
79XX	<ol style="list-style-type: none"> 1. 3117 Adapter
80XX	<ol style="list-style-type: none"> 1. PCMCIA Adapter
84XX	<ol style="list-style-type: none"> 1. Speech Adapter 2. Speech Control Assy.

POST Error Code	FRU/Action
8601, 8602	<ol style="list-style-type: none"> 1. Pointing Device (Mouse) 2. System Board
8603, 8604	<ol style="list-style-type: none"> 1. System Board 2. Pointing Device (Mouse)
86XX Not listed above	<ol style="list-style-type: none"> 1. Mouse 2. System Board
89XX	<ol style="list-style-type: none"> 1. PC Music Adapter 2. MIDI Adapter Unit
91XX	<ol style="list-style-type: none"> 1. Optical Drive 2. Adapter
96XX	<ol style="list-style-type: none"> 1. SCSI Adapter 2. Any SCSI Device 3. System Board 4. Riser card
10101, 10102, 10104 10105, 10106, 10107 10108, 10109, 10111 10112, 10113, 10114 10115, 10116	<ol style="list-style-type: none"> 1. Have customer verify correct operating system device drivers are installed and operational. 2. Modem
10103, 10110, 101171	<ol style="list-style-type: none"> 1. System Board 2. Data/Fax Modem 3. Riser card
10117 Not listed above.	<ol style="list-style-type: none"> 1. Check system speaker 2. Check PSTN cable 3. External DAA (if installed) 4. Modem
10118	<ol style="list-style-type: none"> 1. Run Diagnostics and verify the correct operation of the modem slot 2. Modem
10119	<ol style="list-style-type: none"> 1. Diagnostics detected a non-IBM modem 2. Modem
10120	<ol style="list-style-type: none"> 1. Check PSTN Cable 2. External DAA (if installed) 3. Modem
10132, 10133, 10134 10135, 10136, 10137 10138, 10139, 10140 10141, 10142, 10143 10144, 10145, 10146 10147, 10148, 10149 10150, 10151, 10152	<ol style="list-style-type: none"> 1. Modem
10153	<ol style="list-style-type: none"> 1. Data/Fax Modem 2. System Board 3. Riser card

POST Error Code	FRU/Action
101XX Not listed above.	<ol style="list-style-type: none"> 1. Modem Adapter/A 2. Data/Fax Modem 3. System Board 4. Riser card
10450, 10451, 10490 10491, 10492, 10499 Read/write error.	<ol style="list-style-type: none"> 1. Run Enhanced Diagnostics 2. Hard Disk Drive 3. System Board 4. Riser card
10452 Seek test error.	<ol style="list-style-type: none"> 1. Run Enhanced Diagnostics
10453 Wrong drive type?	Information only
10454 Sector buffer test error.	<ol style="list-style-type: none"> 1. Run Enhanced Diagnostics
10455, 10456 Controller error.	<ol style="list-style-type: none"> 1. Run Enhanced Diagnostics
10459 Drive diagnostic command error.	Information only
10461 Drive format error	<ol style="list-style-type: none"> 1. Run Enhanced Diagnostics
10462 Controller seek error.	<ol style="list-style-type: none"> 1. Run Enhanced Diagnostics
10464 Hard Drive read error.	<ol style="list-style-type: none"> 1. Run Enhanced Diagnostics
10467 Drive non fatal seek error.	<ol style="list-style-type: none"> 1. Run Enhanced Diagnostics
10468 Drive fatal seek error.	<ol style="list-style-type: none"> 1. Run Enhanced Diagnostics
10469 Drive soft error count exceeded.	<ol style="list-style-type: none"> 1. Run Enhanced Diagnostics
10470, 10471, 10472 Controller wrap error.	<ol style="list-style-type: none"> 1. Run Enhanced Diagnostics
10473 Corrupt data. Low level format might be required.	Information only
10480	<ol style="list-style-type: none"> 1. Hard Disk Drive (ESDI) 2. Drive Cable 3. System Board
10481 ESDI drive D seek error.	<ol style="list-style-type: none"> 1. Run Enhanced Diagnostics
10482 Drive select acknowledgement bad.	<ol style="list-style-type: none"> 1. Run Enhanced Diagnostics
106X1	<ol style="list-style-type: none"> 1. Check Configuration 2. Ethernet Adapter

POST Error Code	FRU/Action
10635	<ol style="list-style-type: none"> 1. Power-off computer, wait ten seconds; then power-on the computer. 2. Ethernet Adapter
10651, 10660	<ol style="list-style-type: none"> 1. Check Cables 2. Ethernet Adapter
106XX Not listed above.	<ol style="list-style-type: none"> 1. Ethernet Adapter
107XX	<ol style="list-style-type: none"> 1. 5.25-inch External Diskette Drive 2. 5.25-inch Diskette Drive Adapter/A
109XX Check the adapter cables.	<ol style="list-style-type: none"> 1. ActionMedia Adapter/A 2. System Board 3. Riser card
112XX This adapter does not have cache.	<ol style="list-style-type: none"> 1. SCSI Adapter 2. Any SCSI Device 3. System Board 4. Riser card
119XX	<ol style="list-style-type: none"> 1. 3119 Adapter
121XX	<ol style="list-style-type: none"> 1. Modem Adapter 2. Any Serial Device 3. System Board 4. Riser card
136XX	<ol style="list-style-type: none"> 1. ISDN Primary Rate Adapter 2. System Board 3. Riser card
137XX	<ol style="list-style-type: none"> 1. System Board
141XX	<ol style="list-style-type: none"> 1. Realtime Interface Coprocessor Portmaster™ Adapter/A
143XX	<ol style="list-style-type: none"> 1. Japanese Display Adapter 2. System Board 3. Riser card
14710, 14711	<ol style="list-style-type: none"> 1. System Board Video Adapter 2. Adapter Video Memory
148XX	<ol style="list-style-type: none"> 1. Video Adapter
14901, 14902 1491X, 14922	<ol style="list-style-type: none"> 1. Video Adapter (if installed) 2. System Board 3. Riser card 4. Display (any type)
14932	<ol style="list-style-type: none"> 1. External Display 2. Video Adapter

POST Error Code	FRU/Action
161XX	1. FaxConcentrator™ Adapter
164XX	1. 120 MB Internal Tape Drive 2. Diskette Cable 3. System Board 4. Riser card
16500	1. 6157 Tape Attachment Adapter
16520, 16540	1. 6157 Streaming Tape Drive 2. 6157 Tape Attachment Adapter
166XX, 167XX	1. Token Ring Adapter 2. System Board 3. Riser card
18001 to 18029	1. Wizard Adapter 2. Wizard Adapter Memory
18031 to 18039	1. Wizard Adapter Cable
185XXXX	1. DBCS Japanese Display Adapter/A 2. System Board 3. Riser card
20001 to 20003	1. Image Adapter/A Image-I Adapter/A 2. Memory Module DRAM, VRAM
20004	1. Memory Module DRAM, VRAM 2. Image Adapter/A Image-I Adapter/A
20005 to 20010	1. Image Adapter/A Image-I Adapter/A 2. Memory Module DRAM, VRAM
200XX Not listed above.	1. Image Adapter/A Image-I Adapter/A 2. Memory Module DRAM, VRAM 3. System Board 4. Riser card
20101 to 20103	1. Printer/Scanner Option 2. Image Adapter/A 3. Memory Module DRAM, VRAM
20104	1. Memory Module DRAM, VRAM 2. Printer/Scanner Option 3. Image Adapter/A

POST Error Code	FRU/Action
20105 to 20110	<ol style="list-style-type: none"> Printer/Scanner Option Image Adapter/A Memory Module DRAM, VRAM
Image Adapter/A Memory Test failure indicated by graphic of adapter.	<ol style="list-style-type: none"> Replace memory module (shown in graphic.)
206XX	<ol style="list-style-type: none"> SCSI-2 Adapter Any SCSI Device System Board Riser card
208XX Verify there are no duplicate SCSI ID settings on the same bus.	<ol style="list-style-type: none"> Any SCSI Device
210XXX1 External bus, size unknown.	<ol style="list-style-type: none"> SCSI Hard Disk Drive SCSI Adapter SCSI Cable SCSI ID Switch (on some models)
Tape Drive amber LED remains on.	<ol style="list-style-type: none"> Tape Drive SCSI Cable (internal) SCSI Adapter
Tape Drive green "in use" LED fails to come on.	<ol style="list-style-type: none"> Tape Drive SCSI Adapter SCSI Cable (internal) SCSI Cable (external)
Tape automatically ejected from drive.	<ol style="list-style-type: none"> Tape Cassette Drive
SCSI ID on rotary switch does not match SCSI ID set in configuration. Verify drive switches inside cover are set to zero.	<ol style="list-style-type: none"> Rotary Switch Circuit Board Circuit Board Cable Tape Drive
Tape sticks/breaks in drive. Verify that the tapes used meet ANSI standard X3B5.	<ol style="list-style-type: none"> Tape Cassette
212XX	<ol style="list-style-type: none"> SCSI Printer Printer Cable
213XX	<ol style="list-style-type: none"> SCSI Processor
214XX	<ol style="list-style-type: none"> WORM Drive
215XXXC 215XXXD 215XXXE 215XXXU If an external device, and power-on LED is off, check external voltages.	<ol style="list-style-type: none"> CD-ROM Drive I CD-ROM Drive II Enhanced CD-ROM Drive II Any CD-ROM Drive SCSI Cable SCSI Adapter

POST Error Code	FRU/Action
216XX	1. Scanner
217XX If an external device, and power-on LED is off, check external voltages.	1. Rewritable Optical Drive 2. SCSI Adapter 3. SCSI Cable
218XX Check for multi CD tray, or juke box.	1. Changer
219XX	1. SCSI Communications Device
24201Y0, 24210Y0 Be sure wrap plug is attached.	1. ISDN/2 Adapter 2. ISDN/2 Wrap Plug 3. ISDN/2 Communications Cable
273XX	1. 1 Mbps Micro Channel Infrared LAN Adapter
27501, 27503 27506, 27507	1. ServerGuard Adapter 2. System Board 3. Riser card
27502, 27504, 27510 27511, 27533, 27534 27536, 27537	1. ServerGuard Adapter
27509	1. Remove redundant adapters, run Auto Configuration program, then retest.
27512	1. WMSELF.DGS diagnostics file missing. 2. WMSELF.DGS diagnostics file incorrect.
27535	1. 3V Lithium Backup Battery 2. ServerGuard Adapter
27554	1. Internal Temperature out of range 2. ServerGuard Adapter
27555, 27556	1. ServerGuard Adapter 2. Power Supply
27557	1. 7.2V NiCad Main Battery Pack 2. ServerGuard Adapter
27558, 27559 27560, 27561	1. PCMCIA Type II Modem 2. ServerGuard Adapter

POST Error Code	FRU/Action
27562	<ol style="list-style-type: none"> 1. External Power Control not connected 2. External Power Control 3. ServerGuard Adapter
27563, 27564	<ol style="list-style-type: none"> 1. External Power Control 2. ServerGuard Adapter
275XX	<ol style="list-style-type: none"> 1. Update Diagnostic Software
27801 to 27879	<ol style="list-style-type: none"> 1. Personal Dictation System Adapter 2. System Board 3. Riser card
27880 to 27889	<ol style="list-style-type: none"> 1. External FRU (Speaker, Microphone)
I999030X Hard disk reset failure.	Possible hard disk drive problem, see “Hard disk drive boot error” on page 41.

Miscellaneous error messages

Message/Symptom	FRU/Action
CMOS Backup Battery inaccurate.	<ol style="list-style-type: none"> 1. CMOS Backup Battery See page "Safety information" on page 226. 2. System Board
Changing colors.	<ol style="list-style-type: none"> 1. Display
Computer will not power-off. See "Power supply" on page 29.	<ol style="list-style-type: none"> 1. Power Switch 2. System Board 3. Riser card
Computer will not RPL from server	<ol style="list-style-type: none"> 1. Ensure Network is in startup sequence as first device or first device after diskette. 2. Ensure Network adapter is enabled for RPL. 3. Network adapter (Advise network administrator of new MAC address)
Computer will not Wake On LAN™	<ol style="list-style-type: none"> 1. Check power supply and signal cable connections to network adapter. 2. Ensure Wake On LAN feature is enabled in Setup/Configuration. See "Setup Utility program" on page 41. 3. Ensure network administrator is using correct MAC address. 4. Ensure no interrupt or I/O address conflicts. 5. Network adapter (Advise network administrator of new MAC address)
Dead computer. See "Power supply" on page 29.	<ol style="list-style-type: none"> 1. Power Switch 2. Power Supply 3. System Board 4. Riser card
Diskette drive in-use light remains on or does not light when drive is active.	<ol style="list-style-type: none"> 1. Diskette Drive 2. System Board 3. Diskette Drive Cable 4. Riser card
Flashing cursor with an otherwise blank display.	<ol style="list-style-type: none"> 1. System Board 2. Primary Hard Disk Drive 3. Hard Disk Drive Cable 4. Riser card

Message/Symptom	FRU/Action
Incorrect memory size during POST.	<ol style="list-style-type: none"> 1. Run the Memory tests. 2. Memory Module 3. System Board
"Insert a Diskette" icon appears with a known-good diagnostics diskette in the first 3.5-inch diskette drive.	<ol style="list-style-type: none"> 1. Diskette Drive 2. System Board 3. Diskette Drive Cable 4. Riser card 5. Network Adapter
Intensity or color varies from left to right of characters and color bars.	<ol style="list-style-type: none"> 1. Display 2. System Board
No power, or fan not running.	<ol style="list-style-type: none"> 1. See "Power supply" on page 29.
Non-system disk or disk error-type message with a known-good diagnostic diskette.	<ol style="list-style-type: none"> 1. Diskette Drive 2. System Board 3. Diskette Drive Cable 4. Riser card
Other display symptoms not listed above (including blank or illegible display).	<ol style="list-style-type: none"> 1. See "Display" on page 31. 2. System Board 3. Display
Power-on indicator or hard disk drive in-use light not on, but computer works correctly.	<ol style="list-style-type: none"> 1. Power Supply 2. System Board 3. LED Cables
Printer problems.	<ol style="list-style-type: none"> 1. See "Printer" on page 28.
Program loads from the hard disk with a known-good diagnostics diskette in the first 3.5-inch diskette drive.	<ol style="list-style-type: none"> 1. Run Setup 2. Diskette Drive 3. Diskette Drive Cable 4. System Board 5. Riser card 6. Power Supply
RPL computer cannot access programs from its own hard disk.	<ol style="list-style-type: none"> 1. If network admin. is using LCCM Hybrid RPL, check startup sequence: First device: network; Second device: hard disk 2. Hard disk drive
RPL computer does not RPL from server.	<ol style="list-style-type: none"> 1. Check startup sequence 2. Check the network adapter LED status
Serial or parallel port device failure (system board port).	<ol style="list-style-type: none"> 1. External Device Self-Test OK? 2. External Device 3. Cable 4. System Board

Message/Symptom	FRU/Action
Serial or parallel port device failure (adapter port).	<ol style="list-style-type: none"> 1. External Device Self-Test OK? 2. External Device 3. Cable 4. Alternate Adapter 5. System Board 6. Riser Card
Some or all keys on the keyboard do not work.	<ol style="list-style-type: none"> 1. Keyboard 2. Keyboard Cable 3. System Board

Undetermined problem

Check the power supply voltages. See "Power supply" on page 29. If the voltages are correct, return here and continue with the following steps.

1. Power-off the computer.
2. Remove or disconnect the following, if installed, one at a time:
 - a. Non-IBM devices
 - b. External devices (modem, printer, or mouse)
 - c. Any adapters
 - d. Riser card
 - e. Memory modules
Before removing or replacing memory modules, see "System board memory" on page 59.
 - f. Extended video memory
 - g. External Cache
 - h. External Cache RAM
 - i. Hard disk drive
 - j. Diskette drive
3. Power-on the computer to re-test the system.
4. Repeat steps 1 through 3 until you find the failing device or adapter.

If all devices and adapters have been removed, and the problem continues, replace the system board. See "Replacing a system board" on page 47.

Model tables - Country/Region/Language

Use this table to identify the country/region/language of the specific Models that are listed in the Type/Model configuration tables section.

In most cases, country or language designation will be identified by the last digit of the model number. Some models might be listed twice, as X and (J), for Country/Language identification. (J) is for Japan only.

<i>Table 1. Country/Region/Language Model Definition.</i>	
EMEA	Model
EMEA preload	xx G
North America	Model
US English	xx U
Canadian French	xx F
Latin America (LA)	Model
Portuguese (Brazil)	xx P
LA Spanish	xx S
LA English	xx L
Asia Pacific (AP)	Model
AP English w/Keyboard	xx A
AP English w/o Keyboard	xx B
Japan (Japanese)	xx J
Hong Kong (AP English)	xx H
China (Chinese)	xx C
China (AP English)	xx D
Thailand (Thai)	xx T
Taiwan (Chinese)	xx V
Taiwan (AP English)	xx W
Korea (Korean)	xx K
Korea (AP English)	xx R

Type/Model configuration tables (6584/6594)

Notes

- Some open bay models are identified as AAP (Authorized Assembler Program) models. AAP models are manufactured by IBM without certain devices such as:
 - Graphics
 - Hard Disk Drive
 - CD-ROM unit
 - Memory
 - Video or other option card
 - Preload

AAP IBM Dealers and Business Partners™ install certain devices (IBM options) in these open bay models.

Other than AAP IBM Dealers and Business Partners can purchase these open bay models.

The IBM HelpCenter has information, based on system serial number, for identifying installed IBM options in open bay AAP models.

- 16X Max CD-ROM drive runs at a constant speed. This allows for eight-speed reading at the disk hub and sixteen-speed reading at the disk edge.
 - For 24X Max CD-ROM drives, the disk hub and disk edge speeds are 10X and 24X.
 - For 32X Max CD-ROM drives, the disk hub and disk edge speeds are 14X and 32X.
 - For 40X Max CD-ROM drives, the disk hub and disk edge speeds are 17X and 40X.
 - For 48X Max CD-ROM drives, the disk hub and disk edge speeds are 20X and 48X.

Table	Page
PC 300 Type 6584	107
PC 300 Type 6594	108

Table 2. PC 300 Type 6584 - Desktop

Model	Processor	Memory	Hard Drive	Graphics	Bays/Slots	CD-ROM	Preload
80X - Open Bay	600EB MHz	N/A	N/A	N/A	4X5	N/A	N/A
82X	600EB MHz	128 MB RIMM	20.4 GB EIDE	SR9 4X - 16 MB	4X5	48X Max	Windows 98
83X	600EB MHz	128 MB RIMM	20.4 GB EIDE	SR9 4X - 16 MB	4X5	48X Max	Windows NT
90X - Open Bay	667 MHz	N/A	N/A	N/A	4X5	N/A	N/A
94X	667 MHz	128 MB RIMM	20.4 GB EIDE	SR9 4X - 16 MB	4X5	48X Max	Windows 98
95X	667 MHz	128 MB RIMM	20.4 GB EIDE	SR9 4X - 16 MB	4X5	48X Max	Windows NT
A1X	733 MHz	128 MB RIMM	20.4 GB EIDE	SR9 4X - 16 MB	4X5	48X Max	Windows 98
A2X	733 MHz	128 MB RIMM	20.4 GB EIDE	SR9 4X - 16 MB	4X5	48X Max	Windows NT

Notes:

1. N/A = Not included in model.
2. For last digit model number, see "Model tables - Country/Region/Language" on page 105.
3. Processor = Pentium® III
4. Memory = RAMBUS RIMM
5. Audio = integrated on system board.
6. Models 82X, 83X, 94X, 95X, A1X, A2X come with Ethernet, Alert On LAN 2 card.
7. Open Bay = Authorized Assembler Program. See the note on page 106

Table 3. PC 300 Type 6594 - Microtower

Model	Processor	Memory	Hard Drive	Graphics	Bays/Slots	CD-ROM	Preload
80X - Open Bay	600EB MHz	N/A	N/A	N/A	6X7	N/A	N/A
82X	600EB MHz	128 MB RIMM	20.4 GB EIDE	SR9 4X - 16 MB	6X7	48X Max	Windows NT
90X - Open Bay	667 MHz	N/A	N/A	N/A	6X7	N/A	N/A
92X	667 MHz	128 MB RIMM	20.4 GB EIDE	SR9 4X - 16 MB	6X7	48X Max	Windows NT
E1(J)	667 MHz	128 MB RIMM	13.5 GB EIDE	S3 AGP2 - 8 MB	6X7	48X Max	Windows 98
E2(J)	667 MHz	128 MB RIMM	13.5 GB EIDE	S3 AGP2 - 8 MB	6X7	48X Max	Windows NT

Notes:

1. N/A = Not included in model.
2. For last digit model number, see "Model tables - Country/Region/Language" on page 105.
3. Processor = Pentium® III
4. Memory = RAMBUS RIMM
5. Audio = integrated on system board.
6. All models come with Ethernet, Alert On LAN 2 card except Open Bay Models.
7. Open Bay = Authorized Assembler Program. See the note on page 106

Notes:

Parts (Type 6584)

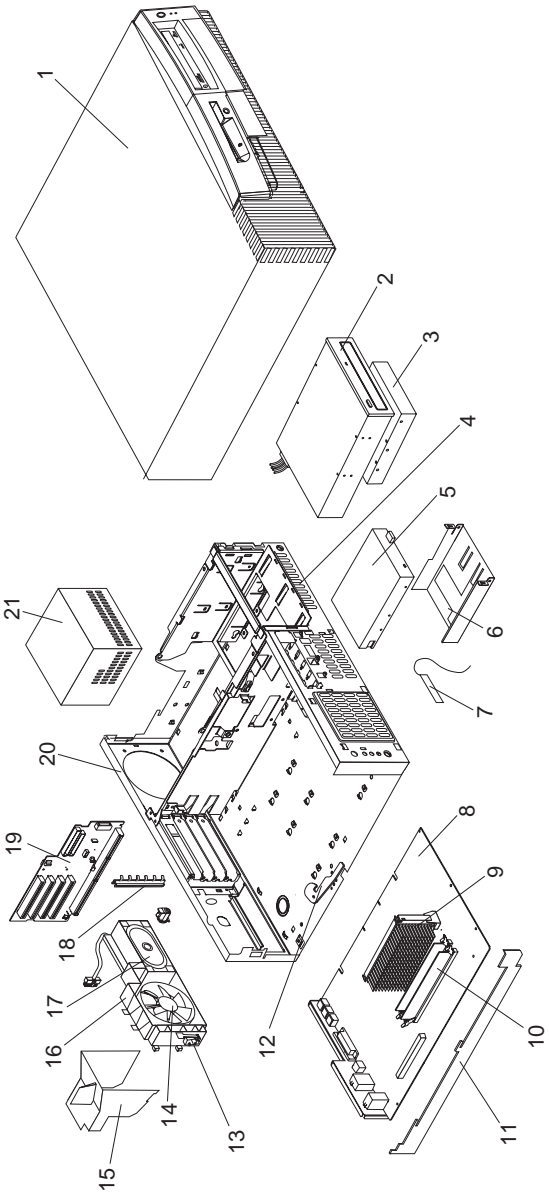

Parts listing

Index	System (Type 6584)	FRU No.
1	Top and Front Cover Assembly	01K6030
2	CD-ROM (48X Max)	09N0735
3	20.4 GB EIDE Hard Disk Drive	36L8628
4	Hard drive Cage Latch Kit	33L2606
5	1.44 MB, 3.5-Inch Diskette Drive	75H9550
5	1.44 MB, 3.5-Inch Diskette Drive (Japan)	75H9552
6	3.5" Diskette Bracket	33L2599
7	RFID Antenna	03K9654
8	System Board (no processor, no memory)	01K2119
9	Pentium III Processor 600/133 MHz.	37L6034
9	Pentium III Processor 677/133 MHz.	00N3622
9	Pentium III Processor 733/133 MHz.	00N7174
10	Memory - 128 MB PC700 Memory RIMM, Non-ECC	33L3102
10	Memory Continuity Card (C-RIMM)	00N5223
11	Side Bracket	03K9662
12	Latch, system board	03K9665
13	C2 Switch Assembly	33L2603
14	Fan 92mm with grommets	33L2594
15	Air Baffle	33L2593
16	Fan Bracket	33L2601
17	Speaker/Cable Assembly	37L5554
18	I/O Bracket	03K9622
19	Riser Card (PCI only)	28L4926
19	Riser Card (PCI/ISA)	37L1531
20	Chassis Assembly with latch	33L2602
21	Power Supply-145W	01K9846
21	Power Supply-145W (China)	36L8836
21	Power Supply-145W (Japan)	01K9848
	Bezel Kit	03K9663
	Cable - CD-ROM, IDE (1 drop)	33L2597
	Cable - Diskette Drive	33L2596
	Cable - Hard Disk, IDE	33L2595
	Cable - Wake On Ring	76H7345
	DASD EMC Shield Kit	33L2600
	Ethernet Adapter - Lake Clark 2.4 Foot (4)	34L1109
	Hard Drive Rails (Qty 2)	01K1539
	Keylock Assembly	02K1428
	LED/Power Switch Cable Assembly	20L3021
	Lithium Battery	33F8354
	Miscellaneous Hardware Kit	33L2605
	Mouse - Scrollpoint 2	28L1865
	Name Plate (6584)	03K9664
	RM Retainer Kit	33L4321
	Savage 2 Video Card - 143 4xAGP	00N5238
	Savage 2 Video Card-4xAGP dongle	09N3435
	SCSI Signal Cable Assembly	33L2735
	System Board Rails	03K9626

Parts (Type 6594)

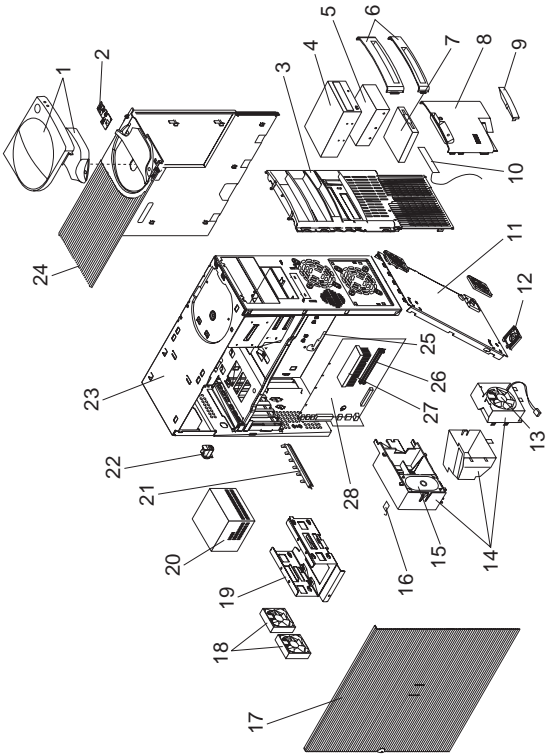

Parts listing

Index	System (Type 6594)	FRU No.
1	Handle Assembly	33L2555
2	Power Switch/LED Cable Assembly	12J4510
3	Front Bezel	12J4495
4	CD-ROM (48X Max)	09N0735
5	13.5 GB EIDE Hard Disk Drive	36L8689
5	20.4 GB EIDE Hard Disk Drive	36L8628
6	Louver Blank Bezels	01K1889
7	1.44 MB, 3.5-Inch Diskette Drive	75H9550
7	1.44 MB, 3.5-Inch Diskette Drive (Japan)	75H9552
8	3.5" Front Panel	01K1854
9	Model Plate	12J4499
10	RFID Antenna	03K9654
11	Bottom Cover Assembly	33L2560
12	Foot (4)	12J6294
13	92MM Fan Assembly with isolators	33L2594
14	Card Guide, Fan Holder, Air Duct	33L2557
15	Speaker with Cable Assembly	03K9607
16	C2 Switch Cable Assembly	01K1495
17	Access Cover Assembly	33L2556
18	60MM Fan Assembly	00N5194
19	Hard Disk Bracket	33L2558
20	Power Supply-200W	75H8991
20	Power Supply-200W (Japan)	76H4873
21	I/O Clamp	33L2562
22	Keylock Assembly	12J5102
23	Chassis Assembly	33L2559
24	Top Cover	12J4509
25	Latch and screw, system board	01K1612
26	Memory - 128 MB PC700 Memory RIMM, Non-ECC	33L3102
26	Memory - 128 MB PC700 Memory RIMM, ECC	33L3108
26	Memory Continuity Card (C-RIMM)	00N5223
27	Pentium III Processor 600/133 MHz.	37L6034
27	Pentium III Processor 667/133 MHz.	00N3622
28	System Board (no processor, no memory)	01K2119
	AGP Card Blank Bracket	03K9623
	Cable - CD-ROM Audio	75H9219
	Cable - Secondary CD-ROM, IDE	12J4518
	Cable - Diskette Drive	76H7340
	Cable - Hard Disk, IDE	33L2564
	Cable - Wake On Ring	76H7345
	Cable - SCSI LVD 5 Drop	37L5558
	Cable - SCSI LED	76H7344
	Ethernet Adapter - Lake Clark 2.4	34L1109
	Lithium Battery	33F8354
	Miscellaneous Hardware Kit	33L2561
	includes:	
	(2)M4X12 Screw, carrying handle	
	(6)I/O blanks	
	(4)M3.5X0.6 screw, thread forming	
	(4)M3.0X0.5 screw, thread forming	
	(12)Rubber isolating grommets	
	(12)6-32 screw, hard drive shoulder	
	Misc. Optional Bezels	09N5871
	Mouse - Scrollpoint 2	28L1865

Index	System (Type 6594)	FRU No.
	Rail, system board	03K9626
	Riser Card PCI only	37L1522
	Riser Card PCI/ISA	37L1531
	Riser Supports, front and rear	02K2766
	RM Retainer Kit	33L4321
	Savage Video Card - 100 2xAGP	00N5237
	Savage Video Card - 143 4xAGP	00N5238
	Savage Video Card 4xAGP dongle	09N3435
	SCSI Adapter	10L7122

Keyboards - PCNext Lite (PC 300 Type 6584/6594)

Arabic	37L2518
Belgian-French	37L2519
Belgian-UK	37L2520
Brazil/Portugal	28L1826
Bulgarian	37L2521
Chinese	37L2548
Czech	37L2522
Danish	37L2523
Dutch	37L2524
French	37L2525
French/Canadian-ID 058	37L0912
French/Canadian-ID 044	37L2515
German	37L2526
Greek	37L2527
Hebrew	37L2528
Hungarian	37L2529
Italian	37L2531
Korean	28L1860
Japanese	28L1858
Latin/Spanish	37L2516
Norwegian	37L2532
Polish	37L2533
Portuguese	37L2534
Romania	37L2535
Russian	37L2536
Serbian/Cyrillic	37L2537
Slovakian	37L2538
Spanish	37L2539
Swed/Finn	37L2540
Swiss French/German	37L2541
Thailand	37L2550
Turkish (ID 179)	37L2542
Turkish (ID 440)	37L2543
UK English	37L2544
US English	37L2514
UK English (ISO Compliant)	37L2546
Yugoslavian	37L2545

Computer Power Cords

Arabic Countries	14F0033
Argentina	36L8880
Australia	93F2365
Belgium	1339520
Bulgaria	1339520
Canada	93F2364
Chile	14F0069
China (Aptiva 2173)	02K0545
Czechoslovakia	1339520
Denmark	13F9997
Finland	1339520
France	1339520
Germany	1339520
Hungary	1339520
Israel	14F0087
Italy	14F0069
Latin-America	6952301
Netherlands	1339520
New Zealand	93F2365
Norway	1339520
Paraguay	36L8880
Poland	1339520
Portugal	1339520
Serbia	1339520
Slovakia	1339520
South Africa	14F0015
Spain	1339520
Switzerland	1339520
Switzerland (French, German)	14F0051
U.S.	93F2364
UK, Ireland	14F0033
Uruguay	36L8880
Yugoslavia	1339520

Display and Monitor Information

Display and monitor information is separately available and is listed under "Related publications" on page vi.

Special tools

The following tools are required to service these computers:

- A volt-ohm meter, IBM P/N 73G5404
- Wrap Plug, IBM P/N 72X8546

IntelliStation - 6867

This section contains the general checkout procedures, additional service information, computer exploded view, Symptom-to-FRU indexes, undetermined problem, model tables, and parts listings for the IBM IntelliStation, type 6867 computer.

Note

This manual and the diagnostic tests are intended to test **only** IBM products. Non-IBM products of any kind including adapter cards, accelerator boards, options, or non-IBM devices, can give false errors and invalid computer responses. If you remove a non-IBM device and the symptom goes away, the problem is with the device you removed.

General checkout	120
Module test menu and hardware configuration report	123
Keyboard	124
Printer	124
Power supply	125
20-pin main power supply connection	126
Display	127
Diagnostics and test information	128
Power-on self-test (POST)	128
POST beep codes	128
Error code format	129
IBM PC Enhanced Diagnostics	130
Starting the IBM PC Enhanced Diagnostics Program	130
Navigating through the diagnostic programs	130
Running diagnostic tests	131
Test selection	131
IBM PC Enhanced Memory Diagnostics	131
Alert On LAN test	132
Asset ID test	132
Test results	132
Hard File Smart Test	133
IBM Fixed Disk Optimized Test	133
Quick and Full erase - hard drive	134
Iomega Zip Drive Test	134
Asset EEPROM backup	134
Viewing the test log	135
RIMM memory errors	135
Setup Utility program	137
Hard disk drive boot error	137
When to use the Low-Level Format program	138
Preparing the hard disk drive for use	138
Product description	139
Specifications Type 6867	140
Additional service information	141

Replacing a processor	141
Replacing a system board	142
Security features	142
Passwords	142
Power-on password	143
Administrator password	144
Administrator password control	144
Operating system password	144
Vital Product Data	144
Management Information Format (MIF)	144
Alert on LAN2	145
Hard disk drive jumper settings	146
IDE hard disk drive settings	146
CD-ROM drive jumper settings	147
BIOS levels	148
Flash (BIOS/VPD) update procedure	149
Flash recovery boot block	149
Power management	150
Automatic configuration and power interface (ACPI) BIOS	150
Advanced Power Management	150
Automatic Hardware Power Management features	150
Setting Automatic Hardware Power Management features	151
Automatic Power-On features	151
Network settings	152
Flash over LAN (update POST/BIOS over network)	152
Wake on LAN	153
System board memory	154
RIMM diagnostic approach	154
Computer exploded view (Type 6867)	156
Input/Output connectors	157
Top and front cover removal	158
CD-ROM/hard drive bracket	159
CD-ROM drive removal	159
Hard drive removal	160
EIDE cable routing	160
SCSI cable routing	160
Diskette drive removal	161
System board removal	162
System board installation	162
Riser card removal	163
Power supply removal	163
Fan bracket removal	164
System board layout	165
System board locations	165
System board jumper settings	166
Riser card (Type 6867)	167
Symptom-to-FRU index	168
Beep symptoms	169
No beep symptoms	170
POST error codes	172

Miscellaneous error messages	187
Undetermined problem	190
Model tables - Country/Region/Language	191
Type/Model configuration tables (6867)	192
Parts (Type 6867)	196
Parts listing	197
Special tools	199

General checkout

This general checkout procedure is for Type 6867 computers.

Attention

The drives in the computer you are servicing might have been rearranged or the drive startup sequence changed. Be extremely careful during write operations such as copying, saving, or formatting. Data or programs can be overwritten if you select an incorrect drive.

Diagnostic error messages appear when a test program finds a problem with a hardware option. For the test programs to properly determine if a test *Passed*, *Failed*, or *Aborted*, the test programs check the error-return code at test completion. See "IBM PC Enhanced Diagnostics" on page 130.

General error messages appear if a problem or conflict is found by an application program, the operating system, or both. For an explanation of these messages, refer to the information supplied with that software package.

Notes

1. Before replacing any FRUs, ensure the latest level of BIOS is installed on the system. A down-level BIOS might cause false errors and unnecessary replacement of the system board. For more information on how to determine and obtain the latest level BIOS, see "BIOS levels" on page 148.
2. If multiple error codes are displayed, diagnose the first error code displayed.
3. If the computer hangs with a POST error, go to "Symptom-to-FRU index" on page 168.
4. If the computer hangs and no error is displayed, go to "Undetermined problem" on page 190.
5. If an installed device is not recognized by the diagnostics program, that device might be defective.

The power-on default is quick bring-up. To enable Enhanced bring-up, select the **Start Options** in the Configuration/Setup Utility program (see "Setup Utility program" on page 137) then, enable **Power On Status**.

001

- Power-off the computer and all external devices.
- Check all cables and power cords.
- Make sure the system board is seated properly.
- Set all display controls to the middle position.

(Step **001** continues)

001 (continued)

- Insert the IBM PC Enhanced Diagnostics diskette into drive A.
- Power-on all external devices.
- Power-on the computer.
- Check for the following response:
 1. Readable instructions or the Main Menu.

Note

Type 6867 computers default to come up quiet (No beep and no memory count and checkpoint code display) when no errors are detected by POST.

To enable Beep and memory count and checkpoint code display when a successful POST occurs:

- Enable **Power on Status** in setup. See “Setup Utility program” on page 137.

DID YOU RECEIVE THE CORRECT RESPONSE?

Yes No

002

If the Power Management feature is enabled, do the following:

1. Start the Configuration/Setup Utility program (see “Setup Utility program” on page 137)
2. Select **Power Management** from the Configuration/Setup Utility program menu.
3. Select **APM**
4. Be sure **APM BIOS Mode** is set to **Disabled**. If it is not, press Left Arrow (←) or Right Arrow (→) to change the setting.
5. Select **Automatic Hardware Power Management**.
6. Set **Automatic Hardware Power Management** to **Disabled**.

– or –

Go to the “IBM PC Enhanced Diagnostics” on page 130.

003

Run the IBM PC Enhanced Diagnostics test. If necessary, refer to “Diagnostics and test information” on page 128.

- If you receive an error, replace the part that the diagnostic program calls out or go to “IBM PC Enhanced Diagnostics” on page 130.
- If the test stops and you cannot continue, replace the last device tested.
- If the computer has incorrect keyboard responses, go to “Keyboard” on page 124.
- If the printer has incorrect responses, go to “Printer” on page 124.

(Step 003 continues)

(CONTINUED)

003 (continued)

- If the display has problems such as jittering, rolling, shifting, or being out of focus, go to “Display” on page 127.
-

Module test menu and hardware configuration report

Depending on the diagnostics version level you are using, the installed devices in the computer are verified in one of two ways:

1. At the start of the diagnostic tests, the Module Test Menu is displayed. Normally, all installed devices in the computer are highlighted on the menu.
2. At the start of the diagnostic tests, the main menu appears. From this menu, select **System Info** then select **Hardware Configuration** from the next menu. Normally, all installed devices in the computer are highlighted on this report.

If an installed device is not recognized by the diagnostics program:

- The diagnostic code for the device is not on the diagnostic diskette. Run the diagnostics provided with that device.
- The missing device is defective or it requires an additional diskette or service manual.
- An unrecognizable device is installed.
- A defective device is causing another device not to be recognized.
- The SCSI controller failed (on the system board or SCSI adapter).
- Use the procedure in "Undetermined problem" on page 190 to find the problem.

If a device is missing from the list, replace it. If this does not correct the problem, use the procedure in "Undetermined problem" on page 190.

Keyboard

Note

If a mouse or other pointing device is attached, remove it to see if the error symptom goes away. If the symptom goes away, the mouse or pointing device is defective.

001

- Power-off the computer.
- Disconnect the keyboard cable from the system unit.
- Power-on the computer and check the keyboard cable connector on the system unit for the voltages shown. All voltages are $\pm 5\%$.

Pin	Voltage (Vdc)
1	+5.0
2	Not Used
3	Ground
4	+5.0
5	+5.0
6	Not Used

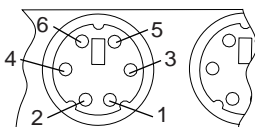

ARE THE VOLTAGES CORRECT?

Yes No

002

Replace the system board.

003

On keyboards with a detachable cable, replace the cable. If the problem remains or if the cable is permanently attached to the keyboard, replace the keyboard. If the problem remains, replace the system board.

Printer

1. Make sure the printer is properly connected and powered on.
2. Run the printer self-test.

If the printer self-test does not run correctly, the problem is in the printer. Refer to the printer service manual.

If the printer self-test runs correctly, install a wrap plug in the parallel port and run the diagnostic tests to determine which FRU failed.

If the diagnostic tests (with the wrap plug installed) do not detect a failure, replace the printer cable. If that does not correct the problem, replace the system board or adapter connected to the printer cable.

Power supply

If the power-on indicator is not on, the power-supply fan is not running, or the computer will not power-off, do the following.

Check/Verify	FRU/Action
1. Verify that the voltage-selector switch is set for the correct voltage.	Correct the voltage-selector switch setting.
2. Check the following for proper installation. <ul style="list-style-type: none">• Power Cord• On/Off Switch connector• On/Off Switch Power Supply connector• System Board Power Supply connectors• microprocessor(s) connection	Reseat
3. Check the power cord for proper continuity.	Power Cord
4. Check the power-on switch for continuity.	Power-on Switch

If the above are correct, check the following voltages.

20-pin main power supply connection

See "System board layout" on page 165 for connector location.

Attention

These voltages must be checked with the power supply cables connected to the system board.

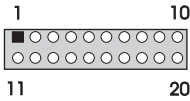

Pin	Signal	Function
1	3.3 V	+3.3 V dc
2	3.3 V	+3.3 V dc
3	COM	Ground
4	5 V	+5 V dc
5	COM	Ground
6	5 V	+5 V dc
7	COM	Ground
8	POK	Power Good
9	5VSB	Standby Voltage
10	12 V	+12 V dc
11	3.3 V	+3.3 V dc
12	-12 V	-12 V dc
13	COM	Ground
14	PS-ON	DC Remote Enable
15	COM	Ground
16	COM	Ground
17	COM	Ground
18	-5 V	-5 V dc
19	5 V	+5 V dc
20	5 V	+5 V dc

If the voltages are not correct, and the power cord is good, replace the power supply.

Display

If the screen is rolling, replace the display assembly. If that does not correct the problem, replace the video adapter (if installed) or replace the system board.

If the screen is not rolling, do the following to run the display self-test:

1. Power-off the computer and display.
2. Disconnect the display signal cable.
3. Power-on the display.
4. Turn the brightness and contrast controls clockwise to their maximum setting.
5. Check for the following conditions:
 - You should be able to vary the screen intensity by adjusting the contrast and brightness controls.
 - The screen should be white or light gray, with a black margin (test margin) on the screen.

Note

The location of the test margin varies with the type of display. The test margin might be on the top, bottom, or one or both sides.

If you do not see any test margin on the screen, replace the display. If there is a test margin on the screen, replace the video adapter (if installed) or replace the system board.

Note

During the first two or three seconds after the display is powered on, the following might occur while the display synchronizes with the computer.

- Unusual patterns or characters
- Static, crackling, or clicking sounds
- A “power-on hum” on larger displays

A noticeable odor might occur on new displays or displays recently removed from storage.

These sounds, display patterns, and odors are normal; do not replace any parts.

If you are unable to correct the problem, go to “Undetermined problem” on page 190.

Diagnostics and test information

The following tools are available to help identify and resolve hardware-related problems:

- Power-on self-test (POST)
- POST Beep Codes
- Error Code Format
- IBM PC Enhanced Diagnostics

Power-on self-test (POST)

Each time you power-on the system, it performs a series of tests that check the operation of the system and some options. This series of tests is called the *power-on self-test*, or *POST*. POST does the following:

- Checks some basic system-board operations
- Checks the memory operation
- Starts the video operation
- Verifies that the diskette drive is working
- Verifies that the hard disk drive is working

If the POST finishes without detecting any problems, a single beep sounds and the first screen of your operating system or application program appears.

Note

Type 6867 computers default to come up quiet (No beep and no memory count and checkpoint code display) when no errors are detected by POST.

To enable Beep and memory count and checkpoint code display when a successful POST occurs:

1. Enable **Power on Status** in setup. See "Setup Utility program" on page 137.

If the POST detects a problem, an error message appears on your screen. A single problem can cause several error messages to appear. When you correct the cause of the first error message, the other error messages probably will not appear on the screen the next time you turn on the system.

POST beep codes

The Power On Self-Test generates a beeping sound to indicate successful completion of POST or to indicate that the tests detect an error.

One beep and the appearance of text on the display indicates successful completion of the POST. More than one beep indicates that the POST detects an error.

Note

Type 6867 computers default to come up quiet (No beep and no memory count and checkpoint code display) when no errors are detected by POST.

To enable Beep and memory count and checkpoint code display when a successful POST occurs:

1. Enable **Power on Status** in setup. See "Setup Utility program" on page 137.

Error code format

This section provides an explanation of the encoded non-SCSI and SCSI POST error codes.

Error messages are displayed on the screen as three, four, five, eight, twelve, or thirteen digits. An "X" in an error message can be any number or letter. The shorter POST errors are highlighted in the Symptom-to-FRU Index. Some digits will represent different information for SCSI errors versus non-SCSI errors.

The following figure shows which digits display the shorter POST errors. The figure also defines additional SCSI information.

Notes

- Non-IBM device error codes and documentation supersede this list.
- Duplicate SCSI ID settings will cause misleading error symptoms or messages.

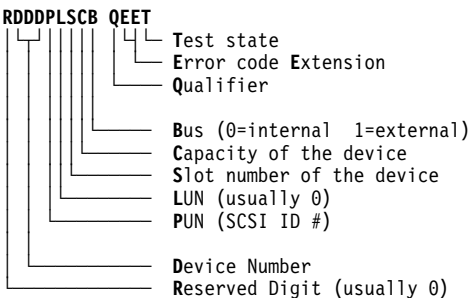

IBM PC Enhanced Diagnostics

The IBM PC Enhanced Diagnostics programs use a full range of diagnostic utilities to determine the operating condition of the computers hardware components. The user interface is WaterGate's PC-Doctor which serves as the control program for running the IBM PC Enhanced Memory Diagnostics and the suite of diagnostic tests provided by PC-Doctor.

The IBM PC Enhanced Diagnostics are available on-line and can be downloaded from:

<http://www.ibm.com/pc/us/>

- Select **Support**
- Select **IBM IntelliStation Support**
- Select **Downloadable Files**
- Select **Diagnostics**

This diagnostic diskette includes:

- A new user interface (WaterGate Software's PC-Doctor)
 - This interface serves as the control program for running both the IBM PC Enhanced Memory Diagnostics and the suite of diagnostic tests provided by PC-Doctor.
- IBM PC Enhanced Memory Diagnostics
 - The memory diagnostic tests determine which memory module (RIMM) is defective and report the socket where the failing module is located. The Memory diagnostics can run a quick and full test of the system. Diagnostics can also be run on a single RIMM.

Note

See "IBM PC Enhanced Diagnostics" for the IBM PC Enhanced Diagnostics error codes.

Starting the IBM PC Enhanced Diagnostics Program

To start the program:

1. Shut down and power-off the system.
2. Wait 10 seconds.
3. Insert the IBM PC Enhanced Diagnostics Diskette into diskette drive A.
4. Power-on the system.

The initial diagnostics menu will be displayed.

Navigating through the diagnostic programs

Use either the mouse or the keyboard to navigate through the Enhanced Diagnostics program.

- Use the cursor movement keys to navigate within the menus.
- The **Enter** key is used to select a menu item.
- The **Esc** key is used to back up to the previous menu.
- For online help select F1.

Running diagnostic tests

There are four ways to run the diagnostic tests:

1. Using the cursor movement keys, highlight **Run Normal Test** or **Run Quick Test** from the Diagnostics Menu and then press **Enter**.

This will automatically run a pre-defined group of tests from each test category. **Run Normal Test** runs a more extensive set of tests than does **Run Quick Test** and takes longer to execute.

2. Press **F5** to automatically run all selected tests in all categories. See "Test selection."
3. From within a test category, press **Ctrl-Enter** to automatically run only the selected tests in that category. See "Test selection."
4. Using the cursor movement keys, highlight a single test within a test category and then press **Enter**. This will run only that test.

Press **Esc** at any time to stop the testing process.

Test results, (N/A, PASSED, FAILED, ABORTED), are displayed in the field beside the test description and in the test log. See "Viewing the test log" on page 135.

Test selection

To select one or more tests:

1. Open the corresponding test category.
2. Using the cursor movement keys, highlight the desired test.
3. Press **Space bar**.

A selected test is marked with a chevron, >>.

Pressing the space bar again de-selects a test and removes the chevron.

4. Repeat steps 2 and 3 above to select all desired tests.

IBM PC Enhanced Memory Diagnostics

The IBM PC Enhanced Memory Diagnostics provide the capability to identify a particular memory module (RIMM) which fails during testing. Use the System Board Layout section to reference the memory sockets, or select **F1 twice** to load the Online Manual and select Chapter 11 'DIMM/RIMM Locator'.

Follow the steps below to locate the IBM PC Enhanced Memory Diagnostics test options.

1. Select the DIAGNOSTICS option on the toolbar and press **Enter**.
2. Highlight either the 'Memory Test-Full' or 'Memory Test-Quick' option and press **Enter**.
 - **Memory Test-Full**
The full memory test will take about 80 seconds per MB of memory and will detect marginal, intermittent, and solid (stuck) memory failures.
 - **Memory Test-Quick**
The quick memory test will take about 20 seconds per MB of memory and will detect solid (stuck) memory failures only.

Notes

Either level of memory testing can be performed on all memory or a single RIMM socket.

Only sockets containing a RIMM can be selected for testing. C-RIMM sockets are noted by besides the test description.

Alert On LAN test

The Alert On LAN test does the following:

- Determines if Alert On LAN is supported on the system.
- Checks the revision ID register.
- Verifies the EEPROM checksum.
- Validates that a software alert can be sent.

Asset ID test

The Asset ID test does the following:

- Determines if Asset ID is supported on the system.
- Verifies the EEPROM areas.
- Performs an antenna detection test.

Test results

IBM PC Enhanced Diagnostic test results will produce this error code format:

Function Code	Failure Type	DeviceID	Date	ChkDigits	Text
---------------	--------------	----------	------	-----------	------

- Function Code:** Represents the feature or function within the PC.
- Failure Type:** Represents the type of error encountered.
- DeviceID:** Contains the component's unit-id which corresponds to either a fixed disk drive, removable media drive, serial or parallel port, processor, specific RIMM, or a device on the PCI bus.

Date:	Contains the date on which the diagnostic test was run. Date is retrieved from CMOS and displayed using the YYYYMMDD format.
ChkDigits:	Contains a 2-digit check-digit value to ensure that: <ul style="list-style-type: none"> • Diagnostics were run on the specified date • Diagnostics were run on the specified IBM computer • The diagnostic error code is recorded correctly
Text:	Description of the error.

Note

See "IBM PC Enhanced Diagnostics error codes" on page 1 for error code listings.

Hard File Smart Test

Use the Hard File Smart Test when the system management tool has detected a hard file SMART alert.

The Smart Test does the following:

- Interrogates IDE devices for support of the SMART instruction set.
- Issues a ENABLE SMART command to make sure SMART functionality is active.
- Checks the SMART RETURN STATUS command to determine if any thresholds have been exceeded.

If thresholds have been exceeded, an error message is shown, and the test fails. If no SMART is supported by the drive, the test returns with N/A.

IBM Fixed Disk Optimized Test

The IBM Fixed Disk Optimized Test provide the capability to identify particular areas of a hard file which fails during testing. This test also provide a method of correcting certain types of errors.

To select the Fixed Disk Optimized Test:

1. Select the diagnostic option on the toolbar and press Enter.
2. Select the Fixed Disk Optimized Test
3. Select Hard Drives - NORMAL TEST to run a complete hard file test.
4. Select Hard Drives - PRESENCE TEST to run a test to check the drive controller and report any SMART information that the drive has detected.

Quick and Full erase - hard drive

The IBM PC Enhanced Diagnostics Program offers two hard drive format utilities:

- Quick Erase Hard Drive
- Full Erase Hard Drive

The Quick Erase Hard Drive provides a DOS utility that performs the following:

- Destroys the Master Boot Record (MBR) on the hard drive.
- Destroys all copies of the FAT Table on all partitions (both the master and backup).
- Destroys the partition table.
- Provides messages that warn the user that this is a non-recoverable process.

The Full Erase Hard Drive provides a DOS utility that performs the following:

- Performs all the steps in Quick Erase.
- Provides a DOS utility that writes random data to all sectors of the hard drive.
- Provide an estimate of time to completion along with a visual representation of completion status.
- Provides messages that warn the user that this is a non-recoverable process.

Important

Make sure customer backs up all data before using the Quick or Full Erase function.

To select the Quick Erase or Full Erase Hard Drive utility:

1. Select the UTILITY option on the toolbar and press enter.
2. Select either the QUICK ERASE or FULL ERASE HARD DISK option and then, follow the instructions.

Iomega Zip Drive Test

Use the Iomega Zip Drive Test to test the zip drive and the drive interface. The test takes about 20 seconds to run.

The default tests the following:

- Controller
- Max Seek (50 times)
- Random Seek (300 sectors)

Asset EEPROM backup

When replacing a system board, this utility allows the backup of all Asset information from the EEPROM to diskette. This utility also restores data to the EEPROM from diskette after replacement of the system board.

To run this utility:

- Select **Utility**
- Select **Asset EEPROM Backup**
- follow instructions on screen.

Viewing the test log

Errors reported by the diagnostic test will be displayed by the program as a failed test.

To view details of a failure or to view a list of test results, do the following from any test category screen:

- Press **F3** to activate the log File
- Press **F3** again to save the file to diskette or F2 to print the file.

RIMM memory errors: SIMM/DIMM/RIMM error messages issued by the IBM PC Enhanced Diagnostics:

Message	Failure Found	Recommended Actions
2xx-1y (for SIMMs)	A memory error was detected in SIMM socket Y	Replace the SIMM in the socket identified by the last digit of the error code. Re-run the test. If the same error code occurs again, replace the system board.
2xx-2y (for DIMMs/RIMMs)	A memory error was detected in DIMM/RIMM socket Y	Replace the DIMM/RIMM in the socket identified by the last digit of the error code. Re-run the test. If the same error code occurs again, replace the system board or where memory is on the processor card, replace the processor card.

Message	Failure Found	Recommended Actions
Corrupt BIOS	<p>Information in BIOS is not as expected.</p> <p>Not able to find expected DMI information from BIOS.</p> <p>Memory controller chipset vendor ID does not match expected value.</p>	<p>Reflash the BIOS.</p> <p>Perform boot block recovery.</p> <p>Replace the system board.</p>
Test aborted by user	User stopped test.	Restart test.
<p>Note:</p> <p>"Y" is the SIMM/DIMM/RIMM socket number. Use the System Board Layouts section in the latest Hardware Maintenance Manual, HMM, to reference the memory sockets.</p>		

Setup Utility program

Attention

A customized setup configuration (other than default settings) might exist on the computer you are servicing. Running the Setup Utility program might alter those settings. Note the current configuration settings and verify that the settings are in place when service is complete. To start the Setup Utility program, see "Setup Utility program."

The Setup Utility (configuration) program is stored in the permanent memory of the computer. This program includes settings for the following:

- System Summary
- Product Data
- Devices and I/O Ports
- Start Options
- Date and Time
- System Security
- Advanced Setup
- ISA Legacy Resources
- Power Management

To run the Setup Utility program, do the following:

1. Power-off the computer and wait for a few seconds until all in-use lights go off.
2. Power-on the computer.
3. When the Setup Utility prompt appears on the screen during start-up, press **F1**. The Setup Utility menu appears.
4. Follow the instructions on the screen.
5. When finished, select System Summary to verify that any configuration changes have been accepted.

Hard disk drive boot error

A hard disk drive boot error (error codes 1962 and I999030X) can be caused by the following:

Cause	Actions
The start-up drive is not in the boot sequence in configuration.	Check the configuration and ensure the start-up drive is in the boot sequence.
No operating system installed on the boot drive.	Install an operating system on the boot drive.

Cause	Actions
The boot sector on the start-up drive is corrupted.	The drive must be formatted, do the following: <ol style="list-style-type: none"> 1. Attempt to access and recover (back-up) the failing hard disk drive. 2. Using the operating systems programs, format the hard disk drive. 3. Go to "Preparing the hard disk drive for use" on page 138.
The drive is defective.	Replace the hard disk drive.

When to use the Low-Level Format program

Notes

1. The low-level format is not available on all diagnostic diskettes.
2. Before formatting the hard disk drive, make a back-up copy of the files on the drive to be formatted.

Use the Low-Level Format program:

- When you are installing software that requires a low-level format
- When you get recurring messages from the test programs directing you to run the Low-Level Format program on the hard disk
- As a last resort before replacing a hard disk drive

Preparing the hard disk drive for use

When the Low-Level Format program is finished, restore to the hard disk all the files that you previously backed up.

1. Partition the remainder of the hard disk for your operating system. (The commands vary with the operating system. Refer to your operating-system manual for instructions.)
2. Format the hard disk using your operating system. (The commands vary with the operating system. Refer to your operating-system manual for instructions.)
3. Install the operating system.

You are now ready to restore the files.

Product description

The IBM IntelliStation Type 6867 computer is available in 4x5, (Four drive bays, Five I/O adapter slots which includes an AGP slot) as a desktop model only.

- **Security**
 - Administrator password
 - Cover lock
 - Power-on password
 - Operating system password
 - U-bolt and cable (Optional for some models)
 - C2 security on some models
- **CMOS backup battery (lithium)**

Specifications Information (ISO/ANSI)

The model specifications information on the following pages was determined in controlled acoustical environments according to procedures specified by the American National Standards Institute (ANSI) S12.10 and ISO 7779, and are reported in accordance with ISO 9296. Actual sound pressure levels in your location might differ from the average values stated because of room reflections and other nearby noise sources. The declared sound power levels indicate an upper limit, below which a large proportion of machines will operate.

Specifications Type 6867

Feature	Description
Size	Depth: 450 mm (17.7 inches) Height: 134 mm (5.3 inches) Width: 447 mm (17.6 inches)
Weight	Weight: 11.3 kg (25 lb) ⁷
Environment	Air temperature: - System on: 10° to 35°C (50° to 95°F) - System off: 10° to 50°C (50° to 122°F) Humidity: - System on: 8% to 80% - System off: 8% to 80% Maximum altitude: 3048 m (10,000 ft)
Heat Output	Approximate heat output in BTUs per hour: - Minimum: 245 BTU (70 watts) - Maximum: 700 BTU (204 watts) ⁸
Electrical Input	Sine-wave input (47 to 63 Hz) required. Low range input voltage: - Minimum: 90 V ac - Maximum: 137 V ac High range input voltage: - Minimum: 180 V ac - Maximum: 265 V ac Input kVA (approximately): - Maximum (as shipped): 0.08 kVA
Airflow	Approximately 0.56 cubic meters/minute (20 CFM)
Acoustical Noise Emission Values	Average sound pressure levels: At operator position: - 41 dB operating - 34 dB idle At bystander position (1 meter): - 34 dB operating - 29 dB idle Declared (upper limit) sound power levels: - 5.0 bels operating - 4.5 bels idle

⁷ Maximum configuration weight depends on options installed. Figures above are a system fully populated with options.

⁸ Maximum power and heat specifications are based on the 145-watt maximum capacity of the system power supply.

⁹ For additional information, see the *ISO Supplier's Declaration* available from IBM.

Additional service information

The following additional service information supports the IBM IntelliStation type 6867 computer.

- “Replacing a processor”
- “Replacing a system board” on page 142
- “Security features” on page 142
- “Passwords” on page 142
- “Vital Product Data” on page 144
- “Management Information Format (MIF)” on page 144
- “Alert on LAN2” on page 145
- “Hard disk drive jumper settings” on page 146
- “CD-ROM drive jumper settings” on page 147
- “BIOS levels” on page 148
- “Flash (BIOS/VPD) update procedure” on page 149
- “Flash recovery boot block” on page 149
- “Power management” on page 150
- “Network settings” on page 152
- “Flash over LAN (update POST/BIOS over network)” on page 152
- “Wake on LAN” on page 153
- “System board memory” on page 154

Replacing a processor

Make sure the processor is fully seated in its socket and that the goal post latches are engaged.

Important

- Make sure the air baffle is installed to prevent processor overheating.
- If the processor is not installed correctly, the system board and the processor can be damaged.

Replacing a system board

Notes

1. The BIOS and Vital Product Data (VPD) for the computer you are servicing must be installed on the new system board (FRU) after it is installed in the computer. To do this, **you must run the Flash Update program using the Flash Update diskette**. See "BIOS levels" on page 148 "Vital Product Data" on page 144, and "Flash (BIOS/VPD) update procedure" on page 149.
2. Always ensure the latest level of BIOS is installed on the computer. A down level BIOS may cause false errors and unnecessary replacement of the system board.
3. The processor is a separate FRU from the system board and is not included with the system board FRU. If you are instructed to replace the system board, do the following.
4. Remove the processor from the old system board and install it on the new system board.
5. Remove any of the following installed options on the old system board, and install them on the new system board.
 - Memory modules (RIMM and C-RIMM)
6. Ensure that the new system board jumper settings match the old system board jumper settings.
7. If the new system board does not correct the problem, reinstall the options on the old system board, reinstall the old system board, then replace the processor.

Security features

Security features in this section include:

- Passwords
- Vital Product Data
- Management Information Format (MIF)
- Alert on LAN

Passwords

The following provides information about computer hardware and software-related passwords:

- Power-on Password
- Administrator Password
- Operating System Password

Power-on and Administrator passwords are set in the Setup Utility program. See "Setup Utility program" on page 137 for information about running the Setup Utility.

Power-on password: A power-on password denies access to the computer by an unauthorized user when the computer is powered on. When a power-on password is active, the password prompt appears on the screen each time the computer is powered on. The computer starts after the proper password is entered.

Removing a power-on password

To service a computer with an active and unknown power-on password, power-off the computer and do the following:

Note

On some models, this procedure will also remove the administrator password.

1. Unplug the power cord and remove the top cover.
2. Refer to “System board layout” on page 165 to find the recovery jumper.
3. Move the recovery jumper from 'normal' to 'clear'.
4. Power-on the computer. The system senses the change in the position and erases the password.
 - It is necessary to move the jumper back to the previous position.
5. Remind the user to enter a new password when service is complete.

Administrator password: The administrator password is used to restrict access to the Configuration/Setup Utility program. If the administrator password is activated, and you do not enter the administrator password, the configuration can be viewed but not changed.

Note

Type 6867 has Enhanced Security Mode. If Enhanced Security mode is enabled and there is no password given, the computer will act as if Enhanced Security is disabled.

If Enhanced Security is Enabled and an administrator password is given, the administrator password must be entered to use the computer. If the administrator password is lost or forgotten, the system board in the computer must be replaced in order to regain access to the Configuration/Setup Utility program.

Administrator password control The Administrator password is set in the Setup Configuration. Refer to "Setup Utility program" on page 137

Operating system password: An operating system password is very similar to a power-on password and denies access to the computer by an unauthorized user when the password is activated. The computer is unusable until the password is entered and recognized by the computer.

Vital Product Data

Each computer has a unique Vital Product Data (VPD) code stored in the nonvolatile memory on the system board. After you replace the system board, the VPD must be updated. To update the VPD, see "Flash (BIOS/VPD) update procedure" on page 149.

Management Information Format (MIF)

Management Information Format (MIF) is a file used to maintain a list of the system unit serial number along with all serialized components; for example: system board, riser card, memory, and processor.

At the time of computer manufacture, the EPROM will be loaded with the serial numbers of the system and all major components. The customer will have access to the MIF file via the DMI MIF Browser that is installed with the preload and is also available on the SSCD provided with the system.

A company called Retain-a-Group is a central data warehouse offering serial number data management. Retain-a-Group acts as a focal point to law enforcement.

The customer has the option to purchase serial number information and services from Retain-a-Group. It is the customer's responsibility to maintain the MIF file and to inform Retain-a-Group of any changes to the file.

Some customers may request their servicers to assist them in maintaining the MIF file when serialized components are replaced during hardware service. This assistance is between the customer and the servicer. The servicer can use the DMI MIF Browser to update the MIF information in the EPROM. It is anticipated that some servicers might charge for this service.

To update the EPROM using the DMI MIF Browser:

1. Click **Start** from the desktop, then **Programs**.
2. Select **IBM SystemView™ Agent**.
3. Select **Serial Number Information** icon.
4. Click the plus sign to expand.
5. Select the component you want to view or edit.
6. Double click on the component you want to change.
7. Enter new data in the **Value** field, then click **Apply**.

Alert on LAN2

Alert on LAN2 provides notification of changes in the computer, even when the computer power is turned off. Working with DMI and Wake on LAN technologies, Alert on LAN2 helps to manage and monitor the hardware and software features of the computer. Alert on LAN2 generates notifications to the server of these occurrences:

- Computer disconnected from the network
- Computer unplugged from the power outlet
- All POST errors
- Operating system or POST hang condition

Alert on LAN2 events are configured to be Enabled or Disabled from the LAN server only, and not from the computer. See the LAN administrator for configuration status information.

Hard disk drive jumper settings

IDE hard disk drives for the IntelliStation computers use jumpers to set the drives as primary (master) or secondary (slave).

Attention

For drives not shown below, refer to the label on the hard disk drive for the hard disk drive settings.

IDE hard disk drive settings

- 1** Primary (Master) Hard Disk Drive
- 2** Secondary (Slave) Hard Disk Drive

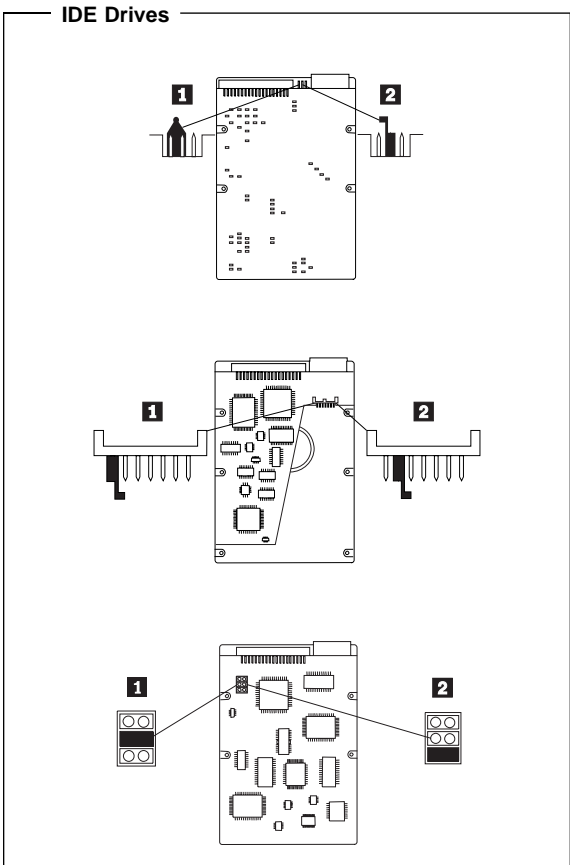

CD-ROM drive jumper settings

CD-ROM and PC/CD-ROM drives use jumpers or tabs to set the drives as primary (master) or secondary (slave). Refer to the drive connector labels or the figures below for the drive settings.

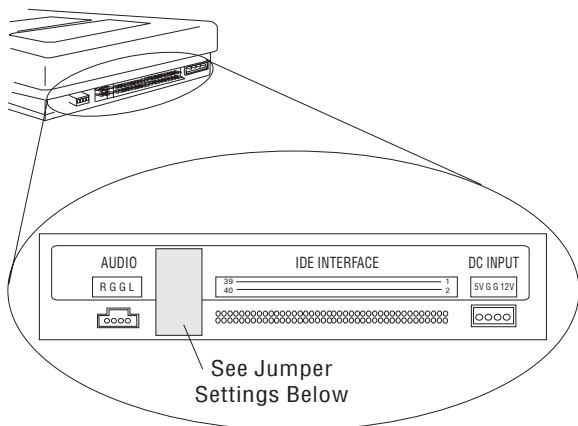

CD-ROM, PD/CD-ROM Type	Primary (Master)	Secondary (Slave)
2X CD-ROM FRU 06H5906	: : ■ : :	: ■ : : :
4X CD-ROM FRU 06H7654	: : ■ : :	: ■ : : :
6X CD-ROM	: : ■	: ■ :
8X CD-ROM	: : ■	: ■ :
6X PD/CD-ROM	: : ■	: ■ :
16X Max CD-ROM	: : ■	: ■ :
24X Max CD-ROM	: : ■	: ■ :
32X Max CD-ROM	: : ■	: ■ :
40X Max CD-ROM	: : ■	: ■ :
48X Max CD-ROM	: : ■	: ■ :

BIOS levels

An incorrect level of BIOS can cause false error and unnecessary FRU replacement. Use the following information to determine the current level of BIOS installed in the computer, the latest BIOS available for the computer, and where to obtain the latest level of BIOS.

- Current Level BIOS information.
 - Run the Configuration Utility to determine the level of BIOS installed.
- Sources for determining the latest level BIOS available.
 1. IBM PC Company Home Page
<http://www.ibm.com/pc/us/>
 2. PC PartnerInfo-Technical Database (CTSTIPS.NSF)
 3. Bulletin Board System (BBS)
 4. HelpCenter™
 5. Levels 1 and 2 Support
 6. RETAIN
- Sources for obtaining the latest level BIOS available.
 1. IBM PC Company Home Page
<http://www.ibm.com/pc/us/>
 2. PC PartnerInfo-Technical Database (CTSTIPS.NSF)
 3. Bulletin board system (BBS)
 4. HelpCenter
 5. Levels 1 and 2 Support

To update (flash) the BIOS, see “Flash (BIOS/VPD) update procedure” on page 149.

Flash (BIOS/VPD) update procedure

Attention

Refer to the information label located inside the system unit cover for any model-specific information.

1. Power-off the computer.
2. Insert the flash update diskette into drive A.
3. Power-on the computer.
4. When the Update Utility appears; select your country/keyboard, then press **Enter**.
5. If the computer serial number was previously recorded, the number is displayed with an option to update it. Press **Y** to update the serial number.
6. Type the 7-digit serial number of the computer you are servicing; then, press **Enter**.
7. Follow the instructions on the screen to complete the flash (BIOS/VPD) update procedure.

Flash recovery boot block

Attention

If an interruption occurs during a Flash/BIOS upgrade, the BIOS might be left in an unusable state. The Boot Block jumper or switch enables you to restart the system and recover the BIOS.

To perform a Flash/BIOS recovery using the recovery jumper:

1. Power-off the computer and remove the cover.
2. Move the system board recovery jumper or switch to the **clear** position. Refer to "System board layout" on page 165 or the information label inside the computer for more information.
3. Insert the upgrade diskette into the diskette drive.
4. Power-on the computer. The IBM Logo will appear.
5. When the Flash Update Utility appears; select your country/keyboard, then press **Enter**.
6. If the computer serial number was previously recorded, the number is displayed with an option to update it. Press **Y** to update the serial number.
7. Type the 7-digit serial number of the computer you are servicing; then, press **Enter**.
8. Follow the instructions on the screen to complete the flash (BIOS/VPD) update procedure.
9. When you are instructed to reboot the computer, power-off the computer and move the recovery jumper to the **normal** position. Then, replace the cover and power-on the computer.

Power management

Power management reduces the power consumption of certain components of the computer such as the system power supply, processor, hard disk drives, and some monitors. Advanced Power Management and Rapid Resume Manager are features of some personal computers.

Automatic configuration and power

interface (ACPI) BIOS: Being an ACPI BIOS system, the operating system is allowed to control the power management features of the computer and the setting for Advanced Power Management (APM) BIOS mode are ignored. Not all operating systems support ACPI BIOS mode.

Advanced Power Management: Energy-saving settings can be viewed and changed by using the Advanced Power Management menu in the Configuration/Setup Utility program.

Attention

If a device, such as a monitor, does not have power-management capabilities, it can be damaged when exposed to a reduced-power state. Before making energy-saving selections for the monitor, check the documentation supplied with the monitor to see if it supports Display Power Management Signaling (DPMS).

Automatic Hardware Power Management

features: Automatic Hardware Power Management can reduce the power states of the computer, processor, and monitor (if monitor supports DPMS) if they are inactive for a predetermined length of time.

There are three levels of specified time that the computer must be inactive before the power management options that are selected take effect. Select the amount of time that is offered within each level.

- Level 1** Set time from 5 minutes to 4 hours.
- Level 2** Set time from 10 minutes to 5 hours.
- Level 3** Set time from 15 minutes to 6 hours.

At each level, you can define the amount of energy savings by specifying values for the following options:

- **System Power:**
 - Select **On** for the computer to remain on.
 - Select **Off** for the computer to shut down.
- **Display:**

Set display to be disabled or to be reduced at these power states:

- **Standby:** Screen is blank, but can be restored immediately when any activity is detected.
- **Suspend:** Monitor uses less power than in Standby mode. Screen image is restored after a few seconds when any activity is detected.
- **Off:** Monitor power is off. Press Monitor power button to restore power. On some monitors, you might have to depress the power button twice.

Setting Automatic Hardware Power Management features

1. Start the Configuration/Setup Utility program (see “Setup Utility program” on page 137).
2. Select **Power Management** from the Configuration/Setup Utility program menu.
3. Select the **APM BIOS Mode** and be sure it is set to **Enabled**. If it is not, press Left Arrow (←) or Right Arrow (→) to change the setting.
4. Select **Automatic Hardware Power Management**.
5. Set **Automatic Hardware Power Management** to **Enabled**.
6. Select values for the two levels of power management (system power and display), as necessary.
7. Set **IDE Drives** to **Enabled** or **Disabled**.
Note: This does not apply to SCSI drives.
8. Select **Low Power Entry Activity Monitor** and enable or disable the listed options.
9. Select **Low Power Exit Activity Monitor** and enable or disable the listed options.
10. Press **Esc** twice to return to the Configuration/Setup Utility program menu.
11. Before you exit from the program, select **Save Settings** from the Configuration/Setup Utility program menu.
12. To exit from the Configuration/Setup Utility program, press **Esc** and follow the instructions on the screen.

Automatic Power-On features: The Automatic Power-On features within the Power Management menu allow you to enable and disable features that turn the computer on automatically.

- **Serial Port Ring Detect:** With this feature set to **Enabled** and an *external* modem connected to serial port (COM1), the computer will turn on automatically when a ring is detected on the modem.

- **Modem Ring Detect:** With this feature set to **Enabled**, the computer will turn on automatically when a ring is detected on the internal modem.
- **Wake Up on Alarm:** You can specify a date and time at which the computer will be turned on automatically. This can be either a single event or a daily event.
- **PCI Wake Up:** PCI Wake Up uses PCI Power Management Enabled (PME) to wake up the computer when using token-ring, Ethernet LAN adapters, modems, or other PCI cards capable of waking up the computer. When you set PCI Wake Up to **Enabled**, the computer will turn on when it receives a specific signal from another computer on the local area network (LAN) or from a modem signal. Wake on LAN features can be used on the 6867 computer. For further information, see "Wake on LAN" on page 153.

Network settings

This section applies only to computers linked to a network.

The Configuration/Setup Utility program includes settings that can be enabled and disabled to configure the network interface in the computer. These settings are:

- Flash over LAN (Update POST/BIOS over Network)
- Wake on LAN

Flash over LAN (update POST/BIOS over network)

Note: For local Flash (BIOS/VPD) update, see "Flash (BIOS/VPD) update procedure" on page 149.

This setting is used to enable or disable the Flash over LAN feature. When the feature is enabled, the system programs, in the computer, can be updated remotely from a network server. If the administrator password is set in the computer, it does not have to be entered by the server.

To access the Flash over LAN setting:

1. Start the Configuration/Setup Utility program. See "Setup Utility program" on page 137.
2. Select **System Security**.
3. Select **POST/BIOS Update** from the Configuration/Setup Utility program menu.
4. To enable Flash over LAN, select **Enabled**. To disable Flash over LAN, select **Disabled**.
5. Press **Esc** twice to return to the Configuration/Setup Utility program menu.
6. Before you exit from the program, select **Save Settings** from the Configuration/Setup Utility program menu.

7. To exit from the Configuration/Setup Utility program, press **Esc** and follow the instructions on the screen.

Wake on LAN

This setting is used to enable or disable the IBM-developed Wake on LAN feature. This feature makes it possible for the computer to be turned on remotely by a network server. Remote network management software must be used in conjunction with this feature.

To access the Wake on LAN setting:

1. Start the Configuration/Setup Utility program. See "Setup Utility program" on page 137.
2. Select **Advanced Power Management**.
3. Select **Automatic Power On** from the program menu.
4. Select **Wake on LAN** from the **Automatic Power On** menu.
5. To enable Wake on LAN, select **Enabled**. To disable Wake on LAN, select **Disabled**.
6. Press **Esc** until you return to the Configuration/Setup Utility program menu.
7. Before you exit from the program, select **Save Settings** from the Configuration/Setup Utility program menu.
8. To exit from the Configuration/Setup Utility program, press **Esc** and follow the instructions on the screen.

System board memory

The following matrix cross-references the name of the computer (printed on the logo) and the size, speed, and type of memory modules supported in the computer.

Note

RAMBUS inline memory module (RIMM) is used in the type 6867 computer. RIMM modules are not compatible with SIMM or DIMM memory modules. Refer to the information below regarding RIMM memory for type 6867.

Computer Name	RIMM Memory Module		
	Size	Memory	Type
IntelliStation Type 6867	128 MB	PC700/	RDRAM ECC/ Non-ECC
	256 MB	PC800	
	512 MB Maximum	PC800 only	

Note

For maximum 512 MB configuration, two 256 MB PC800 memory RIMMs must be installed. PC700 memory RIMMs can not be used.

Supported RIMM memory configuration

Type 6867 has two RIMM memory sockets. RIMM sockets must either have a RIMM memory module or a C-RIMM (RIMM Continuity module) installed. There can be no empty RIMM sockets. At least one socket must have a RIMM memory module installed.

- If new memory is to be added, remove a C-RIMM and install the new RIMM.
- If memory is to be removed, remove the RIMM and install a C-RIMM.

RIMM sizes of 128 MB and 256 MB are acceptable. RIMM sockets can be filled in any order. ECC or non-ECC, RAMBUS dynamic random access memory (RDRAM) are supported.

Note

Mixed RIMM speeds will run at the lower speed.

RIMM diagnostic approach

Identify any Beep or POST codes. See "Symptom-to-FRU index" on page 168.

Use the IBM PC Enhanced Diagnostics program to run memory tests. See "IBM PC Enhanced Diagnostics error codes" on page 1.

Procedures to determine memory errors:

1. If a memory error occurs, and the system is operational, run memory diagnostics.
2. If a memory error occurs, and the system is not operational:
 - a. Remove one RIMM module at a time until the system comes up.

Note

All unused RIMM sockets must have a C-RIMM installed.

- b. Run memory diagnostics.
- c. Install the other RIMM and run diagnostics again to identify the failing RIMM.

Computer exploded view (Type 6867)

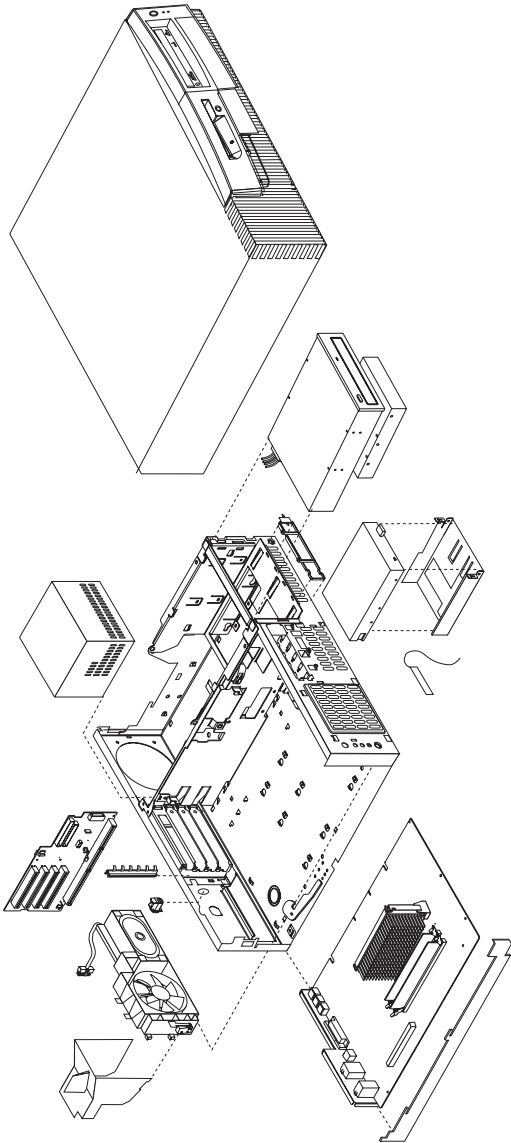

I/O connectors and removal procedures for the cover, CD-ROM/hard drive bracket, CD-ROM drive, hard drive, EIDE and SCSI cable routing, Diskette drive, system board, riser card, power supply, and fan/speaker bracket removal are on the following pages.

Input/Output connectors

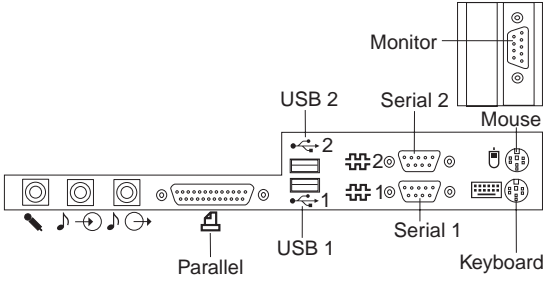

Top and front cover removal

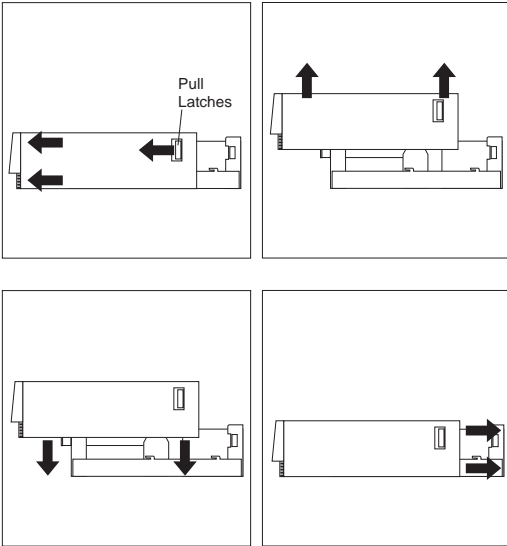

To remove top and front cover:

1. Pull left and right pull latches forward then pull cover forward.
2. Lift cover up from the chassis.

To install top and front cover:

1. Slide cover down onto the chassis about 4-inches (10.16 cm) from the rear of chassis.
2. Slide cover back to engage the left and right latches.

CD-ROM/hard drive bracket

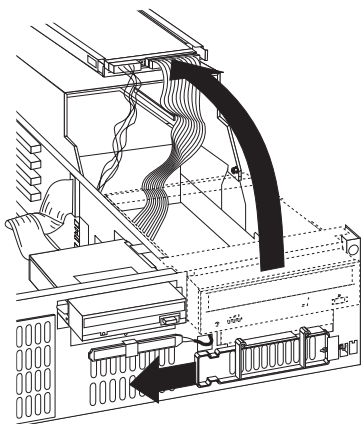

To open the CD-ROM/hard drive bracket:

1. Remove the top cover.
2. Slide the plastic spring loaded cage retainer to the left.
3. Lift the cage up and swing it back to the service position.

CD-ROM drive removal

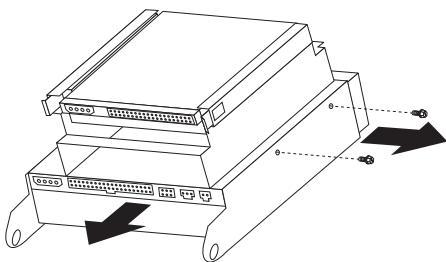

To remove the CD-ROM drive:

1. Remove the top cover.
2. Put the CD-ROM/hard drive bracket in its service position.
3. Disconnect the CD-ROM signal and power cables.
4. Remove two screws securing the CD-ROM drive.
5. Pull the CD-ROM drive out of the bracket.

Hard drive removal

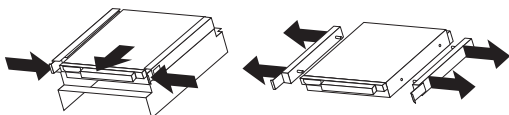

To remove the hard drive:

1. Remove the top cover.
2. Put the CD-ROM/hard drive bracket in its service position.
3. Disconnect the hard drive signal and power cables.
4. Push in on the left and right plastic tabs of the hard drive rails.
5. Pull the hard drive out of the bracket.

Note

Remove the plastic rails from the old hard drive and install them on the new hard drive.

EIDE cable routing

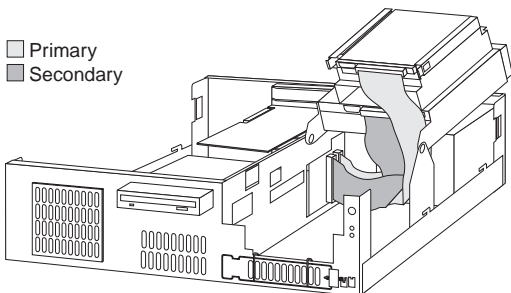

SCSI cable routing

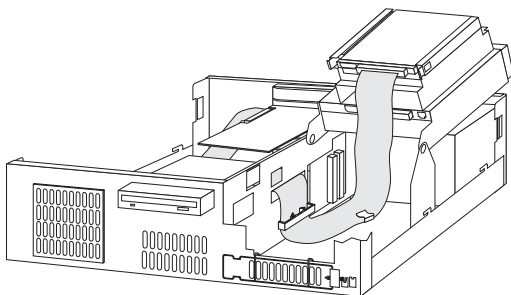

Diskette drive removal

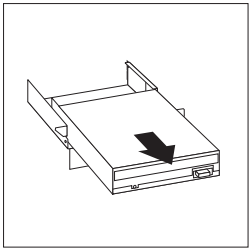
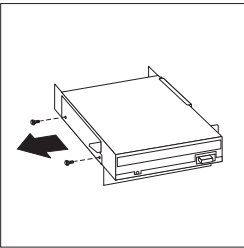
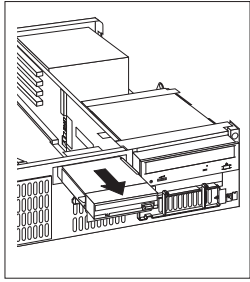
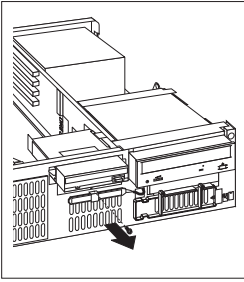

To remove the diskette drive:

1. Remove the top cover.
2. Disconnect the diskette drive signal and power cables.
3. Remove the front screw of the diskette drive cage.
4. Pull the diskette drive out of the chassis.
5. Remove the two side screws from the diskette drive cage.
6. Remove the diskette drive from its cage.

System board removal

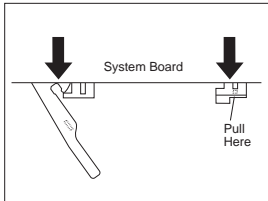
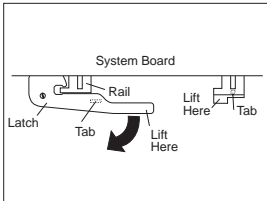
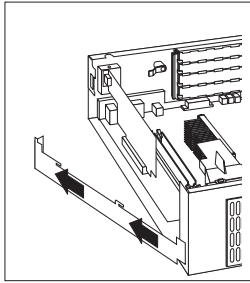
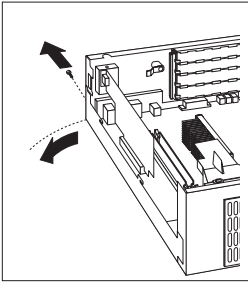

To remove the system board:

1. Remove the top cover.
2. Remove all cables connected to the system board.
3. Remove the AGP card, if installed.
4. Remove the retainer side bracket thumb screw.
5. Swing open the retainer side bracket and remove it from the chassis.
6. Lift up on the system board right-hand rail tab to disengage it from the bottom of the chassis.
7. Rotate the latch handle to disengage the system board.

System board installation

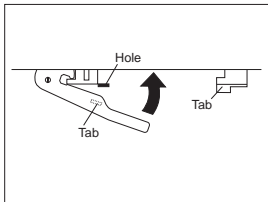
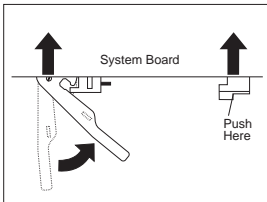

Rotate the latch handle and firmly push in on the end of the right-hand rail to engage the tab in the opening of the chassis.

Riser card removal

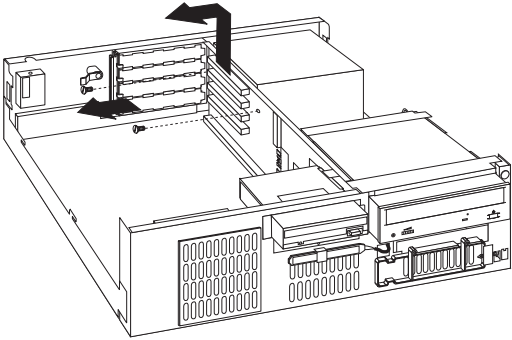

To remove the riser card:

1. Remove the top cover.
2. Remove the system board.
3. Disconnect all cables from the front and back of the riser card.
4. Remove the two top screws securing the riser card.
5. Remove the riser card from the chassis.

Power supply removal

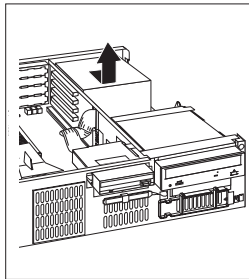
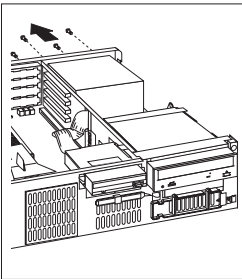

Note

1. Make sure the power supply voltage switch is set to the proper operating voltage; 115V or 230V.

To remove the power supply:

1. Remove the top cover.
2. Disconnect the power supply connectors.
3. Remove the four screws securing the power supply to the chassis.
4. Move power supply inward, then lift out of the chassis.

Fan bracket removal

Note

1. If you remove the LED/power cable or the RFID antenna cable, make sure it is routed the same way it was installed.
2. When removing the C2 switch assembly from the fan bracket, use care to pry the switch (alternating at both ends of the switch) from its mounting studs.
3. Make sure the RFID antenna cable is grounded to the chassis by its grounding lug.

To remove the fan bracket:

1. Remove the top cover.
2. Remove the air duct.
3. Disconnect the fan and speaker connectors.
4. Push on the outside tab to release the bracket from the chassis.
5. Swing the bracket inward and then pull it from the chassis.

System board layout

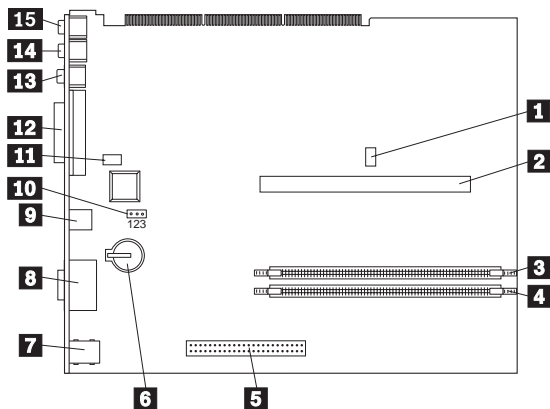

System board locations

- | | |
|-----------|------------------------------------|
| 1 | Processor fan connector (not used) |
| 2 | Processor socket |
| 3 | RIMM socket 1 |
| 4 | RIMM socket 2 |
| 5 | AGP connector |
| 6 | Battery |
| 7 | Keyboard/Mouse connectors |
| 8 | Serial 1,2 connectors |
| 9 | USB connectors |
| 10 | Recovery jumper |
| 11 | PC PCI connector (not used) |
| 12 | Parallel connector |
| 13 | Line Out connector |
| 14 | Line In connector |
| 15 | Microphone connector |

System board jumper settings

The following table contains the jumper setting information. (D) indicates the default setting.

Clear CMOS/Flash Boot Block Recovery

Use this jumper setting to Clear CMOS or to Flash Boot Block Recover.

Jumper	Setting	Description
Clear CMOS	2-3	Clear CMOS/ Flash Recovery Mode
	1-2 (D)	Normal Mode

Processor Speed Settings

Processor speed for the IBM IntelliStation 6867 computers are fixed and are determined by the processor. There are no settings required.

Diskette Write Access

Diskette Write Enable and Write Protect options are changed in the Setup Configuration. See "Setup Utility program" on page 137.

Riser card (Type 6867)

Riser card, PCI, front view

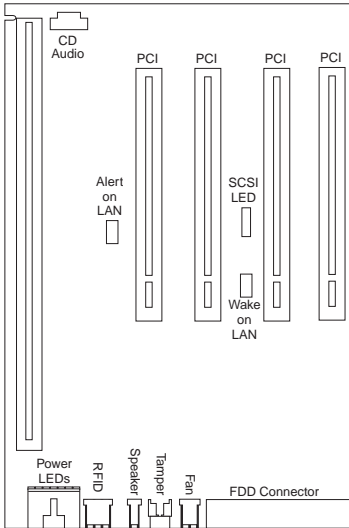

Riser card, back view

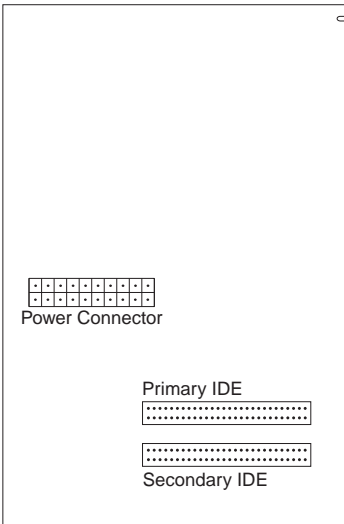

Symptom-to-FRU index

The Symptom-to-FRU index lists error symptoms and possible causes. The most likely cause is listed first. Always begin with "General checkout" on page 120. See "IBM PC Enhanced Diagnostics error codes" on page 1 when running diagnostics. This index can also be used to help you decide which FRUs to have available when servicing a computer. If you are unable to correct the problem using this index, go to "Undetermined problem" on page 190.

Notes

- If you have both an error message and an incorrect audio response, diagnose the error message first.
- If you cannot run the diagnostic tests or you get a diagnostic error code when running a test, but did receive a POST error message, diagnose the POST error message first.
- If you did not receive any error message, look for a description of your error symptoms in the first part of this index.
- Check all power supply voltages before you replace the system board. (See "Power supply" on page 125.)
- Check the hard disk drive jumper settings before you replace a hard disk drive. (See "Hard disk drive jumper settings" on page 146.)

Important

1. Some errors are indicated with a series of beep codes. (See "Beep symptoms" on page 169.)
Type 6867 computers default to come up quiet (No beep and no memory count and checkpoint code display) when no errors are detected by POST. To enable Beep and memory count and checkpoint code display when a successful POST occurs:
 - Enable **Power on Status** in setup. See "Setup Utility program" on page 137.
2. The processor is a separate FRU from the system board; the processor is not included with the system board FRU.

Beep symptoms

Beep symptoms are short tones or a series of short tones separated by pauses (intervals without sound). See the following examples.

Beeps	Description
1-2-X	<ul style="list-style-type: none"> • One Beep • A pause (or break) • Two beeps • A pause (or break) • Any number of beeps
4	Four continuous beeps

Beep Symptom	FRU/Action
1-1-3 CMOS read/write error	<ol style="list-style-type: none"> 1. Run Setup 2. System Board
1-1-4 ROM BIOS check error	<ol style="list-style-type: none"> 1. System Board
1-2-X DMA error	<ol style="list-style-type: none"> 1. System Board
1-3-X	<ol style="list-style-type: none"> 1. RIMM Memory Module see "System board memory" on page 154 2. C-RIMM 3. System Board
1-4-4	<ol style="list-style-type: none"> 1. Keyboard 2. System Board
1-4-X Error detected in first 64 KB of RAM.	<ol style="list-style-type: none"> 1. Memory Module 2. System Board
2-1-1, 2-1-2	<ol style="list-style-type: none"> 1. Run Setup 2. System Board
2-1-X First 64 KB of RAM failed.	<ol style="list-style-type: none"> 1. Memory Module 2. System Board
2-2-2	<ol style="list-style-type: none"> 1. Video Adapter (if installed) 2. System Board
2-2-X First 64 KB of RAM failed.	<ol style="list-style-type: none"> 1. Memory Module 2. System Board
2-3-X	<ol style="list-style-type: none"> 1. Memory Module 2. System Board
2-4-X	<ol style="list-style-type: none"> 1. Run Setup 2. Memory Module 3. System Board
3-1-X DMA register failed.	<ol style="list-style-type: none"> 1. System Board
3-2-4 Keyboard controller failed.	<ol style="list-style-type: none"> 1. System Board 2. Keyboard

Beep Symptom	FRU/Action
3-3-4 Screen initialization failed.	<ol style="list-style-type: none"> Video Adapter (if installed) System Board Display
3-4-1 Screen retrace test detected an error.	<ol style="list-style-type: none"> Video Adapter (if installed) System Board Display
3-4-2 POST is searching for video ROM.	<ol style="list-style-type: none"> Video Adapter (if installed) System Board
4	<ol style="list-style-type: none"> Video Adapter (if installed) System Board
All other beep code sequences.	1. System Board
One long and one short beep during POST. Base 640 KB memory error or shadow RAM error.	<ol style="list-style-type: none"> Memory Module System Board
One long beep and two or three short beeps during POST. (Video error)	<ol style="list-style-type: none"> Video Adapter (if installed) System Board
Three short beeps during POST.	<ol style="list-style-type: none"> See "System board memory" on page 154. System Board
Continuous beep.	1. System Board
Repeating short beeps.	<ol style="list-style-type: none"> Keyboard stuck key? Keyboard Cable System Board

No beep symptoms

Note

Type 6867 computers default to come up quiet (No beep and no memory count and checkpoint code display) when no errors are detected by POST.

To enable Beep and memory count and checkpoint code display when a successful POST occurs:

- Enable **Power on Status** in setup. See "Setup Utility program" on page 137.

Symptom/Error	FRU/Action
No beep during POST but computer works correctly.	1. System Board

Symptom/Error	FRU/Action
No beep during POST.	<ol style="list-style-type: none"> 1. See “Undetermined problem” on page 190. 2. System Board 3. Memory Module 4. Any Adapter or Device 5. Riser Card 6. Power Cord 7. Power Supply

POST error codes

In the following index, "X" can represent any number.

POST Error Code	FRU/Action
000 SCSI Adapter not enabled.	1. Verify adapter device and Bus Master fields are enabled in PCI configuration program. See documentation shipped with computer.
02X	1. SCSI Adapter
08X Check SCSI terminator installation.	1. SCSI Cable 2. SCSI Terminator 3. SCSI Device 4. SCSI Adapter
101 System board interrupt failure.	1. System Board
102 System board timer error.	1. System Board
106	1. System Board
110 System board memory parity error.	1. Memory Module 2. System Board
111 I/O channel parity error.	1. Reseat adapters 2. Any Adapter 3. Riser card 4. System Board
114 Adapter ROM error.	1. Adapter Memory 2. System Board 3. Riser card
129 Internal cache test error.	1. Processor 2. L2 Cache Memory 3. System Board
151 Real-time clock failure.	1. System Board
161 Bad CMOS battery.	1. Run Setup 2. CMOS Backup Battery (See page "Safety information" on page 226.) 3. System Board

POST Error Code	FRU/Action
<p>162 Configuration mismatch.</p>	<ol style="list-style-type: none"> 1. Run Setup and verify Configuration 2. Had a device been added, removed, changed location? If not, suspect that device. 3. Power-on external devices first, then power-on computer. 4. CMOS Backup Battery (See page "Safety information" on page 226.) 5. System Board 6. Riser card
<p>162 And unable to run diagnostics.</p>	<ol style="list-style-type: none"> 1. Diskette Drive 2. System Board 3. Diskette Drive Cable 4. Riser card
<p>163 Clock not updating or invalid time set.</p>	<ol style="list-style-type: none"> 1. Time and Date Set? 2. CMOS Backup Battery (See page "Safety information" on page 226.) 3. System Board
<p>164 POST detected a base memory or extended memory size mismatch error. or RIMM socket 3 is populated with a RIMM memory module.</p>	<ol style="list-style-type: none"> 1. Run Setup. Check System Summary menu for memory size change. (See "Setup Utility program" on page 137.) 2. Run the Extended Memory Diagnostic tests. 3. Replace RIMM memory module in socket 3 with a C-RIMM
<p>166 Boot Block Check Sum Error</p>	<ol style="list-style-type: none"> 1. Run Flash Recovery using Boot Block. See "Flash recovery boot block" on page 149 2. System Board
<p>167 Microprocessor installed that is not supported by the current POST/BIOS.</p>	<ol style="list-style-type: none"> 1. Run Setup. Check Stepping level for the BIOS level needed, then perform the flash update. 2. Processor

POST Error Code	FRU/Action
168 Alert on LAN2 error	<ol style="list-style-type: none"> 1. Run Setup. Check to see that Ethernet and Alert on LAN2 are enabled. 2. System Board 3. Riser card
17X, 18X	<ol style="list-style-type: none"> 1. C2 Security
175	<ol style="list-style-type: none"> 1. Run Configuration (See "Setup Utility program" on page 137.) 2. System Board
176	<ol style="list-style-type: none"> 1. Covers were removed from the computer.
177 Corrupted Administrator Password.	<ol style="list-style-type: none"> 1. System Board
178	<ol style="list-style-type: none"> 1. System Board
183	<ol style="list-style-type: none"> 1. Enter the administrator password
184 No RFID Antenna	<ol style="list-style-type: none"> 1. Make sure Asset Care and Asset ID™ are enabled in Configuration/Setup. 2. RFID Antenna 3. System Board 4. Riser card
185 Corrupted boot sequence.	<ol style="list-style-type: none"> 1. Set configuration and reinstall the boot sequence.
186	<ol style="list-style-type: none"> 1. System Board
187	<ol style="list-style-type: none"> 1. Clear Administration password 2. System Board
189	<ol style="list-style-type: none"> 1. More than three password attempts were made to access the computer.
190 Chassis intrusion detector was cleared. This is information only, no action required. If this code does not clear:	<ol style="list-style-type: none"> 1. System Board
1XX Not listed above.	<ol style="list-style-type: none"> 1. System Board
201, 20X Memory data error.	<ol style="list-style-type: none"> 1. Run Enhanced Diag. Memory Test 2. Memory Module 3. System Board
225	<ol style="list-style-type: none"> 1. Unsupported Memory

POST Error Code	FRU/Action
229 External cache test error.	1. L2 Cache Memory 2. System Board
262 POST detected a base memory or extended memory type error.	1. Run Setup. Check System Summary menu for memory type change. (See "Setup Utility program" on page 137.) 2. Run the Extended Memory Diagnostic tests.
301	1. Keyboard 2. Keyboard Cable 3. System Board
303 With an 8603 error.	1. Mouse 2. Keyboard 3. Keyboard Cable 4. System Board
303 With no 8603 error.	1. Keyboard 2. Keyboard Cable 3. System Board
3XX Not listed above.	1. Keyboard 2. Keyboard Cable 3. System Board
5XX	1. Video Adapter (if installed) 2. System Board
601	1. Diskette Drive A 2. Diskette Drive Cable 3. System Board 4. Riser card
602	1. Bad Diskette ? 2. Verify Diskette and retry.
604 And able to run diagnostics.	1. Run Setup and verify diskette configuration settings 2. Diskette Drive A/B 3. Diskette Drive Cable 4. System Board 5. Riser card
605 POST cannot unlock the diskette drive.	1. Diskette Drive 2. Diskette Drive Cable 3. System Board 4. Riser card
662	1. Diskette drive configuration error or wrong diskette drive type, run Setup Configuration.

POST Error Code	FRU/Action
6XX Not listed above.	<ol style="list-style-type: none"> 1. Diskette Drive 2. System Board 3. Riser card 4. External Drive Adapter 5. Diskette Drive Cable 6. Power Supply
762 Math coprocessor configuration error.	<ol style="list-style-type: none"> 1. Run Setup 2. Processor 3. System Board
7XX Not listed above.	<ol style="list-style-type: none"> 1. Processor 2. System Board
962 Parallel port configuration error.	<ol style="list-style-type: none"> 1. Run Configuration 2. Parallel Adapter (if installed) 3. System Board
9XX	<ol style="list-style-type: none"> 1. Printer 2. System Board
1047	<ol style="list-style-type: none"> 1. 16-Bit AT Fast SCSI Adapter
107X Check SCSI terminator installation.	<ol style="list-style-type: none"> 1. Check SCSI terminator installation. 2. SCSI Cable 3. SCSI Terminator 4. SCSI Device 5. SCSI Adapter
1101 Serial connector error, possible system board failure.	<ol style="list-style-type: none"> 1. Run Enhanced Diagnostics
1101, 1102, 1106, 1108, 1109	<ol style="list-style-type: none"> 1. System Board 2. Any Serial Device
1107	<ol style="list-style-type: none"> 1. Communications Cable 2. System Board
1102 Card selected feedback error.	<ol style="list-style-type: none"> 1. Run Enhanced Diagnostics
1103 Port fails register check.	<ol style="list-style-type: none"> 1. Run Enhanced Diagnostics 2. System Board
1106 Serial option cannot be turned off.	<ol style="list-style-type: none"> 1. Run Enhanced Diagnostics 2. System Board
1107	<ol style="list-style-type: none"> 1. Serial Device Cable 2. System Board
1110 Register test failed.	<ol style="list-style-type: none"> 1. Run Enhanced Diagnostics 2. System Board
1116 Interrupt error.	<ol style="list-style-type: none"> 1. Run Enhanced Diagnostics

POST Error Code	FRU/Action
1117 Failed baud rate test.	1. Run Enhanced Diagnostics
1162 Serial port configuration error.	1. Run Configuration 2. Serial Adapter (if installed) 3. System Board
11XX Not listed above.	1. System Board
1201	1. System Board 2. Any Serial Device
1202, 1206, 1208, 1209, 12XX	1. Dual Async Adapter/A 2. System Board 3. Any Serial Device
1207	1. Communications Cable 2. Dual Async Adapter/A
13XX	1. Game Adapter
1402 Printer not ready.	Information only
1403 No paper error, or interrupt failure.	Information only
1404 System board timeout failure.	1. Run Enhanced Diagnostics
1405 Parallel adapter error.	1. Run Enhanced Diagnostics
1406 Presence test error.	1. Run Enhanced Diagnostics
14XX Not listed above. Check printer before replacing system board.	1. Printer 2. System Board
15XX	1. SDLC Adapter
1692 Boot sequence error.	1. Run FDISK to ensure at least one active partition is set active.
16XX	1. 36/38 Workstation Adapter
1762 Hard disk drive configuration error.	1. Run Configuration (See "Setup Utility program" on page 137.)
1780 (Disk Drive 0) 1781 (Disk Drive 1) 1782 (Disk Drive 2) 1783 (Disk Drive 3)	1. See "Power supply" on page 125. 2. Hard Disk Drive 3. System Board 4. Riser card 5. Hard Disk Cable 6. Power Supply

POST Error Code	FRU/Action
180X, 188X PCI configuration or resource error.	<ol style="list-style-type: none"> 1. Run Setup and verify PCI/ISA configuration settings. 2. If necessary, set ISA adapters to "Not available" to allow PCI adapters to properly configure. 3. Remove any suspect ISA adapters. 4. Rerun diagnostics. 5. PCI Adapter
1962 Boot sequence error.	<ol style="list-style-type: none"> 1. Possible hard disk drive problem, see "Hard disk drive boot error" on page 41.
209X	<ol style="list-style-type: none"> 1. Diskette Drive 2. Diskette Cable 3. 16-bit AT Fast SCSI Adapter
20XX Not listed above	<ol style="list-style-type: none"> 1. BSC Adapter
21XX	<ol style="list-style-type: none"> 1. SCSI Device 2. 16-bit AT Fast SCSI Adapter 3. Alternate BSC Adapter
2401, 2402 If screen colors change.	<ol style="list-style-type: none"> 1. Display
2401, 2402 If screen colors are OK.	<ol style="list-style-type: none"> 1. System Board 2. Display
2409	<ol style="list-style-type: none"> 1. Display
2410	<ol style="list-style-type: none"> 1. System Board 2. Display
2462 Video memory configuration error.	<ol style="list-style-type: none"> 1. Check cable connections. 2. Run Setup and verify video configuration settings. 3. Video Memory Modules 4. Video Adapter (if installed) 5. System Board
3015, 3040 Check for missing wrap or terminator plug on the adapter.	<ol style="list-style-type: none"> 1. Network Attached? 2. LF Translator 3. Cable Problem 4. PC Network Adapter
30XX	<ol style="list-style-type: none"> 1. PC Network Adapter 2. LF Translator 3. Cable Problem?

POST Error Code	FRU/Action
3115, 3140	<ol style="list-style-type: none"> Network Attached? LF Translator Alternate PC Network-Adapter Cable Problem
31XX	<ol style="list-style-type: none"> Alternate PC Network Adapter LF Translator Cable Problem
36XX	<ol style="list-style-type: none"> GPIB Adapter
38XX	<ol style="list-style-type: none"> DAC Adapter
4611, 4630	<ol style="list-style-type: none"> Multiport/2 Interface Board Multiport/2 Adapter
4612, 4613 4640, 4641	<ol style="list-style-type: none"> Memory Module Package Multiport/2 Adapter
4650	<ol style="list-style-type: none"> Multiport Interface Cable
46XX Not listed above.	<ol style="list-style-type: none"> Multiport/2 Adapter Multiport/2 Interface Board Memory Module
5600	<ol style="list-style-type: none"> Financial System Controller Adapter
5962 An IDE device (other than hard drive) configuration error.	<ol style="list-style-type: none"> Run Configuration CD-ROM Drive CD-ROM Adapter ZIP or other ATAPI device System Board Riser card
62XX	<ol style="list-style-type: none"> 1st Store Loop Adapter Adapter Cable
63XX	<ol style="list-style-type: none"> 2nd Store Loop Adapter Adapter Cable
64XX	<ol style="list-style-type: none"> Network Adapter
71XX	<ol style="list-style-type: none"> Voice Adapter
74XX	<ol style="list-style-type: none"> Video Adapter (if installed)
76XX	<ol style="list-style-type: none"> Page Printer Adapter
78XX	<ol style="list-style-type: none"> High Speed Adapter
79XX	<ol style="list-style-type: none"> 3117 Adapter
80XX	<ol style="list-style-type: none"> PCMCIA Adapter
84XX	<ol style="list-style-type: none"> Speech Adapter Speech Control Assy.

POST Error Code	FRU/Action
8601, 8602	<ol style="list-style-type: none"> 1. Pointing Device (Mouse) 2. System Board
8603, 8604	<ol style="list-style-type: none"> 1. System Board 2. Pointing Device (Mouse)
86XX Not listed above	<ol style="list-style-type: none"> 1. Mouse 2. System Board
89XX	<ol style="list-style-type: none"> 1. PC Music Adapter 2. MIDI Adapter Unit
91XX	<ol style="list-style-type: none"> 1. Optical Drive 2. Adapter
96XX	<ol style="list-style-type: none"> 1. SCSI Adapter 2. Any SCSI Device 3. System Board 4. Riser card
10101, 10102, 10104 10105, 10106, 10107 10108, 10109, 10111 10112, 10113, 10114 10115, 10116	<ol style="list-style-type: none"> 1. Have customer verify correct operating system device drivers are installed and operational. 2. Modem
10103, 10110, 101171	<ol style="list-style-type: none"> 1. System Board 2. Data/Fax Modem 3. Riser card
10117 Not listed above.	<ol style="list-style-type: none"> 1. Check system speaker 2. Check PSTN cable 3. External DAA (if installed) 4. Modem
10118	<ol style="list-style-type: none"> 1. Run Diagnostics and verify the correct operation of the modem slot 2. Modem
10119	<ol style="list-style-type: none"> 1. Diagnostics detected a non-IBM modem 2. Modem
10120	<ol style="list-style-type: none"> 1. Check PSTN Cable 2. External DAA (if installed) 3. Modem
10132, 10133, 10134 10135, 10136, 10137 10138, 10139, 10140 10141, 10142, 10143 10144, 10145, 10146 10147, 10148, 10149 10150, 10151, 10152	<ol style="list-style-type: none"> 1. Modem
10153	<ol style="list-style-type: none"> 1. Data/Fax Modem 2. System Board 3. Riser card

POST Error Code	FRU/Action
101XX Not listed above.	<ol style="list-style-type: none"> 1. Modem Adapter/A 2. Data/Fax Modem 3. System Board 4. Riser card
10450, 10451, 10490 10491, 10492, 10499 Read/write error.	<ol style="list-style-type: none"> 1. Run Enhanced Diagnostics 2. Hard Disk Drive 3. System Board 4. Riser card
10452 Seek test error.	<ol style="list-style-type: none"> 1. Run Enhanced Diagnostics
10453 Wrong drive type?	Information only
10454 Sector buffer test error.	<ol style="list-style-type: none"> 1. Run Enhanced Diagnostics
10455, 10456 Controller error.	<ol style="list-style-type: none"> 1. Run Enhanced Diagnostics
10459 Drive diagnostic command error.	Information only
10461 Drive format error	<ol style="list-style-type: none"> 1. Run Enhanced Diagnostics
10462 Controller seek error.	<ol style="list-style-type: none"> 1. Run Enhanced Diagnostics
10464 Hard Drive read error.	<ol style="list-style-type: none"> 1. Run Enhanced Diagnostics
10467 Drive non fatal seek error.	<ol style="list-style-type: none"> 1. Run Enhanced Diagnostics
10468 Drive fatal seek error.	<ol style="list-style-type: none"> 1. Run Enhanced Diagnostics
10469 Drive soft error count exceeded.	<ol style="list-style-type: none"> 1. Run Enhanced Diagnostics
10470, 10471, 10472 Controller wrap error.	<ol style="list-style-type: none"> 1. Run Enhanced Diagnostics
10473 Corrupt data. Low level format might be required.	Information only
10480	<ol style="list-style-type: none"> 1. Hard Disk Drive (ESDI) 2. Drive Cable 3. System Board
10481 ESDI drive D seek error.	<ol style="list-style-type: none"> 1. Run Enhanced Diagnostics
10482 Drive select acknowledgement bad.	<ol style="list-style-type: none"> 1. Run Enhanced Diagnostics
106X1	<ol style="list-style-type: none"> 1. Check Configuration 2. Ethernet Adapter

POST Error Code	FRU/Action
10635	<ol style="list-style-type: none"> 1. Power-off computer, wait ten seconds; then power-on the computer. 2. Ethernet Adapter
10651, 10660	<ol style="list-style-type: none"> 1. Check Cables 2. Ethernet Adapter
106XX Not listed above.	<ol style="list-style-type: none"> 1. Ethernet Adapter
107XX	<ol style="list-style-type: none"> 1. 5.25-inch External Diskette Drive 2. 5.25-inch Diskette Drive Adapter/A
109XX Check the adapter cables.	<ol style="list-style-type: none"> 1. ActionMedia Adapter/A 2. System Board 3. Riser card
112XX This adapter does not have cache.	<ol style="list-style-type: none"> 1. SCSI Adapter 2. Any SCSI Device 3. System Board 4. Riser card
119XX	<ol style="list-style-type: none"> 1. 3119 Adapter
121XX	<ol style="list-style-type: none"> 1. Modem Adapter 2. Any Serial Device 3. System Board 4. Riser card
136XX	<ol style="list-style-type: none"> 1. ISDN Primary Rate Adapter 2. System Board 3. Riser card
137XX	<ol style="list-style-type: none"> 1. System Board
141XX	<ol style="list-style-type: none"> 1. Realtime Interface Coprocessor Portmaster™ Adapter/A
143XX	<ol style="list-style-type: none"> 1. Japanese Display Adapter 2. System Board 3. Riser card
14710, 14711	<ol style="list-style-type: none"> 1. System Board Video Adapter 2. Adapter Video Memory
148XX	<ol style="list-style-type: none"> 1. Video Adapter
14901, 14902 1491X, 14922	<ol style="list-style-type: none"> 1. Video Adapter (if installed) 2. System Board 3. Riser card 4. Display (any type)
14932	<ol style="list-style-type: none"> 1. External Display 2. Video Adapter

POST Error Code	FRU/Action
161XX	1. FaxConcentrator™ Adapter
164XX	1. 120 MB Internal Tape Drive 2. Diskette Cable 3. System Board 4. Riser card
16500	1. 6157 Tape Attachment Adapter
16520, 16540	1. 6157 Streaming Tape Drive 2. 6157 Tape Attachment Adapter
166XX, 167XX	1. Token Ring Adapter 2. System Board 3. Riser card
18001 to 18029	1. Wizard Adapter 2. Wizard Adapter Memory
18031 to 18039	1. Wizard Adapter Cable
185XXXX	1. DBCS Japanese Display Adapter/A 2. System Board 3. Riser card
20001 to 20003	1. Image Adapter/A Image-I Adapter/A 2. Memory Module DRAM, VRAM
20004	1. Memory Module DRAM, VRAM 2. Image Adapter/A Image-I Adapter/A
20005 to 20010	1. Image Adapter/A Image-I Adapter/A 2. Memory Module DRAM, VRAM
200XX Not listed above.	1. Image Adapter/A Image-I Adapter/A 2. Memory Module DRAM, VRAM 3. System Board 4. Riser card
20101 to 20103	1. Printer/Scanner Option 2. Image Adapter/A 3. Memory Module DRAM, VRAM
20104	1. Memory Module DRAM, VRAM 2. Printer/Scanner Option 3. Image Adapter/A

POST Error Code	FRU/Action
20105 to 20110	<ol style="list-style-type: none"> Printer/Scanner Option Image Adapter/A Memory Module DRAM, VRAM
Image Adapter/A Memory Test failure indicated by graphic of adapter.	<ol style="list-style-type: none"> Replace memory module (shown in graphic.)
206XX	<ol style="list-style-type: none"> SCSI-2 Adapter Any SCSI Device System Board Riser card
208XX Verify there are no duplicate SCSI ID settings on the same bus.	<ol style="list-style-type: none"> Any SCSI Device
210XXX1 External bus, size unknown.	<ol style="list-style-type: none"> SCSI Hard Disk Drive SCSI Adapter SCSI Cable SCSI ID Switch (on some models)
Tape Drive amber LED remains on.	<ol style="list-style-type: none"> Tape Drive SCSI Cable (internal) SCSI Adapter
Tape Drive green "in use" LED fails to come on.	<ol style="list-style-type: none"> Tape Drive SCSI Adapter SCSI Cable (internal) SCSI Cable (external)
Tape automatically ejected from drive.	<ol style="list-style-type: none"> Tape Cassette Drive
SCSI ID on rotary switch does not match SCSI ID set in configuration. Verify drive switches inside cover are set to zero.	<ol style="list-style-type: none"> Rotary Switch Circuit Board Circuit Board Cable Tape Drive
Tape sticks/breaks in drive. Verify that the tapes used meet ANSI standard X3B5.	<ol style="list-style-type: none"> Tape Cassette
212XX	<ol style="list-style-type: none"> SCSI Printer Printer Cable
213XX	<ol style="list-style-type: none"> SCSI Processor
214XX	<ol style="list-style-type: none"> WORM Drive
215XXXC 215XXXD 215XXXE 215XX XU If an external device, and power-on LED is off, check external voltages.	<ol style="list-style-type: none"> CD-ROM Drive I CD-ROM Drive II Enhanced CD-ROM Drive II Any CD-ROM Drive SCSI Cable SCSI Adapter

POST Error Code	FRU/Action
216XX	1. Scanner
217XX If an external device, and power-on LED is off, check external voltages.	1. Rewritable Optical Drive 2. SCSI Adapter 3. SCSI Cable
218XX Check for multi CD tray, or juke box.	1. Changer
219XX	1. SCSI Communications Device
24201Y0, 24210Y0 Be sure wrap plug is attached.	1. ISDN/2 Adapter 2. ISDN/2 Wrap Plug 3. ISDN/2 Communications Cable
273XX	1. 1 Mbps Micro Channel Infrared LAN Adapter
27501, 27503 27506, 27507	1. ServerGuard Adapter 2. System Board 3. Riser card
27502, 27504, 27510 27511, 27533, 27534 27536, 27537	1. ServerGuard Adapter
27509	1. Remove redundant adapters, run Auto Configuration program, then retest.
27512	1. WMSELF.DGS diagnostics file missing. 2. WMSELF.DGS diagnostics file incorrect.
27535	1. 3V Lithium Backup Battery 2. ServerGuard Adapter
27554	1. Internal Temperature out of range 2. ServerGuard Adapter
27555, 27556	1. ServerGuard Adapter 2. Power Supply
27557	1. 7.2V NiCad Main Battery Pack 2. ServerGuard Adapter
27558, 27559 27560, 27561	1. PCMCIA Type II Modem 2. ServerGuard Adapter

POST Error Code	FRU/Action
27562	<ol style="list-style-type: none"> 1. External Power Control not connected 2. External Power Control 3. ServerGuard Adapter
27563, 27564	<ol style="list-style-type: none"> 1. External Power Control 2. ServerGuard Adapter
275XX	<ol style="list-style-type: none"> 1. Update Diagnostic Software
27801 to 27879	<ol style="list-style-type: none"> 1. Personal Dictation System Adapter 2. System Board 3. Riser card
27880 to 27889	<ol style="list-style-type: none"> 1. External FRU (Speaker, Microphone)
I999030X Hard disk reset failure.	Possible hard disk drive problem, see “Hard disk drive boot error” on page 41.

Miscellaneous error messages

Message/Symptom	FRU/Action
CMOS Backup Battery inaccurate.	<ol style="list-style-type: none"> 1. CMOS Backup Battery See page "Safety information" on page 226. 2. System Board
Changing colors.	<ol style="list-style-type: none"> 1. Display
Computer will not power-off. See "Power supply" on page 125.	<ol style="list-style-type: none"> 1. Power Switch 2. System Board 3. Riser card
Computer will not RPL from server	<ol style="list-style-type: none"> 1. Ensure Network is in startup sequence as first device or first device after diskette. 2. Ensure Network adapter is enabled for RPL. 3. Network adapter (Advise network administrator of new MAC address)
Computer will not Wake On LAN™	<ol style="list-style-type: none"> 1. Check power supply and signal cable connections to network adapter. 2. Ensure Wake On LAN feature is enabled in Setup/Configuration. See "Setup Utility program" on page 137. 3. Ensure network administrator is using correct MAC address. 4. Ensure no interrupt or I/O address conflicts. 5. Network adapter (Advise network administrator of new MAC address)
Dead computer. See "Power supply" on page 125.	<ol style="list-style-type: none"> 1. Power Switch 2. Power Supply 3. System Board 4. Riser card
Diskette drive in-use light remains on or does not light when drive is active.	<ol style="list-style-type: none"> 1. Diskette Drive 2. System Board 3. Diskette Drive Cable 4. Riser card
Flashing cursor with an otherwise blank display.	<ol style="list-style-type: none"> 1. System Board 2. Primary Hard Disk Drive 3. Hard Disk Drive Cable 4. Riser card

Message/Symptom	FRU/Action
Incorrect memory size during POST.	<ol style="list-style-type: none"> 1. Run the Memory tests. 2. Memory Module 3. System Board
"Insert a Diskette" icon appears with a known-good diagnostics diskette in the first 3.5-inch diskette drive.	<ol style="list-style-type: none"> 1. Diskette Drive 2. System Board 3. Diskette Drive Cable 4. Riser card 5. Network Adapter
Intensity or color varies from left to right of characters and color bars.	<ol style="list-style-type: none"> 1. Display 2. System Board
No power, or fan not running.	<ol style="list-style-type: none"> 1. See "Power supply" on page 125.
Nonsystem disk or disk error-type message with a known-good diagnostic diskette.	<ol style="list-style-type: none"> 1. Diskette Drive 2. System Board 3. Diskette Drive Cable 4. Riser card
Other display symptoms not listed above (including blank or illegible display).	<ol style="list-style-type: none"> 1. See "Display" on page 127. 2. System Board 3. Display
Power-on indicator or hard disk drive in-use light not on, but computer works correctly.	<ol style="list-style-type: none"> 1. Power Supply 2. System Board 3. LED Cables
Printer problems.	<ol style="list-style-type: none"> 1. See "Printer" on page 124.
Program loads from the hard disk with a known-good diagnostics diskette in the first 3.5-inch diskette drive.	<ol style="list-style-type: none"> 1. Run Setup 2. Diskette Drive 3. Diskette Drive Cable 4. System Board 5. Riser card 6. Power Supply
RPL computer cannot access programs from its own hard disk.	<ol style="list-style-type: none"> 1. If network admin. is using LCCM Hybrid RPL, check startup sequence: First device: network; Second device: hard disk 2. Hard disk drive
RPL computer does not RPL from server.	<ol style="list-style-type: none"> 1. Check startup sequence 2. Check the network adapter LED status
Serial or parallel port device failure (system board port).	<ol style="list-style-type: none"> 1. External Device Self-Test OK? 2. External Device 3. Cable 4. System Board

Message/Symptom	FRU/Action
Serial or parallel port device failure (adapter port).	<ol style="list-style-type: none"> 1. External Device Self-Test OK? 2. External Device 3. Cable 4. Alternate Adapter 5. System Board 6. Riser Card
Some or all keys on the keyboard do not work.	<ol style="list-style-type: none"> 1. Keyboard 2. Keyboard Cable 3. System Board

Undetermined problem

Check the power supply voltages. See "Power supply" on page 125. If the voltages are correct, return here and continue with the following steps.

1. Power-off the computer.
2. Remove or disconnect the following, if installed, one at a time:
 - a. Non-IBM devices
 - b. External devices (modem, printer, or mouse)
 - c. Any adapters
 - d. Riser card
 - e. Memory modules
Before removing or replacing memory modules, see "System board memory" on page 154.
 - f. Extended video memory
 - g. External Cache
 - h. External Cache RAM
 - i. Hard disk drive
 - j. Diskette drive
3. Power-on the computer to re-test the system.
4. Repeat steps 1 through 3 until you find the failing device or adapter.

If all devices and adapters have been removed, and the problem continues, replace the system board. See "Replacing a system board" on page 142.

Model tables - Country/Region/Language

Use this table to identify the country/region/language of the specific Models that are listed in the Type/Model configuration tables section.

In most cases, country or language designation will be identified by the last digit of the model number. Some models might be listed twice, as X and (J), for Country/Language identification. (J) is for Japan only.

<i>Table 4. Country/Region/Language Model Definition.</i>	
EMEA	Model
EMEA preload	xxG
North America	Model
US English	xxU
Canadian French	xxF
Latin America (LA)	Model
Portuguese (Brazil)	xxP
LA Spanish	xxS
LA English	xxL
Asia Pacific (AP)	Model
AP English w/Keyboard	xxA
AP English w/o Keyboard	xxB
Japan (Japanese)	xxJ
Hong Kong (AP English)	xxH
China (Chinese)	xxC
China (AP English)	xxD
Thailand (Thai)	xxT
Taiwan (Chinese)	xxV
Taiwan (AP English)	xxW
Korea (Korean)	xxK
Korea (AP English)	xxR

Type/Model configuration tables (6867)

Notes

- Some open bay models are identified as AAP (Authorized Assembler Program) models. AAP models are manufactured by IBM without certain devices such as:
 - Graphics
 - Hard Disk Drive
 - CD-ROM unit
 - Memory
 - Video or other option card
 - Preload

AAP IBM Dealers and Business Partners™ install certain devices (IBM options) in these open bay models.

Other than AAP IBM Dealers and Business Partners can purchase these open bay models.

The IBM HelpCenter has information, based on system serial number, for identifying installed IBM options in open bay AAP models.

- 16X Max CD-ROM drive runs at a constant speed. This allows for eight-speed reading at the disk hub and sixteen-speed reading at the disk edge.
 - For 24X Max CD-ROM drives, the disk hub and disk edge speeds are 10X and 24X.
 - For 32X Max CD-ROM drives, the disk hub and disk edge speeds are 14X and 32X.
 - For 40X Max CD-ROM drives, the disk hub and disk edge speeds are 17X and 40X.
 - For 48X Max CD-ROM drives, the disk hub and disk edge speeds are 20X and 48X.

Table	Page
IntelliStation Type 6867	193

Table 5 (Page 1 of 2). IntelliStation Type 6867 - Desktop

Model	Processor	Memory	Hard Drive	Graphics	Bays/Slots	CD-ROM	Preload
12X	600 MHz	128 MB RIMM	13.5 GB EIDE	Matrox G400	4X5	48X Max	Windows NT
13X	600 MHz	128 MB RIMM	9.1 GB SCSI	Matrox G400	4X5	48X Max	Windows NT
15X	600 MHz	128 MB RIMM	9.1 GB SCSI	IBM Fire GL 1	4X5	48X Max	Windows NT
17X	600 MHz	128 MB RIMM	13.5 GB EIDE	Appian Gemini	4X5	48X Max	Windows NT
30X	667 MHz	128 MB RIMM	13.5 GB EIDE	Matrox G400	4X5	48X Max	Windows NT
32X	667 MHz	128 MB RIMM	9.1 GB SCSI	Matrox G400	4X5	48X Max	Windows NT
34X	667 MHz	128 MB RIMM	13.5 GB EIDE	IBM Fire GL 1	4X5	48X Max	Windows NT
35X	667 MHz	128 MB RIMM	9.1 GB SCSI	IBM Fire GL 1	4X5	48X Max	Windows NT
37X	667 MHz	128 MB RIMM	9.1 GB SCSI	Appian Gemini	4X5	48X Max	Windows NT

Notes:

1. N/A = Not included in model.
2. For last digit model number, see "Model tables - Country/Region/Language" on page 191.
3. Certain countries might have DOS license instead of Windows NT. Customer may install any operating system.
4. Processor = Pentium® III with 512 KB L2 Cache
5. Memory = ECC RAMBUS RIMM
6. Graphics = 2D Matrox G400 (AGP) - 16 MB, 3D IBM Fire GL1 (AGP) - 32 MB.
7. Audio = integrated on system board.
8. All models come with Ethernet adapter card with RJ-45 connector.
9. Open Bay = Authorized Assembler Program. See the note on page 192

Table 5 (Page 2 of 2). IntelliStation Type 6867 - Desktop

Model	Processor	Memory	Hard Drive	Graphics	Bays/Slots	CD-ROM	Preload
39X - Open Bay	667 MHz	N/A	N/A	N/A	4X5	48X Max	N/A
40X	733 MHz	128 MB RIMM	13.5 GB EIDE	Matrox G400	4X5	48X Max	Windows NT
45X	733 MHz	128 MB RIMM	9.1 GB SCSI	IBM Fire GL 1	4X5	48X Max	Windows NT
49X - Open Bay	733 MHz	N/A	N/A	N/A	4X5	48X Max	N/A
19X - Open Bay	600 MHz	N/A	N/A	N/A	4X5	48X Max	N/A

Notes:

1. N/A = Not included in model.
2. For last digit model number, see "Model tables - Country/Region/Language" on page 191.
3. Certain countries might have DOS license instead of Windows NT. Customer may install any operating system.
4. Processor = Pentium® III with 512 KB L2 Cache
5. Memory = ECC RAMBUS RIMM
6. Graphics = 2D Matrox G400 (AGP) - 16 MB, 3D IBM Fire GL1 (AGP) - 32 MB.
7. Audio = integrated on system board.
8. All models come with Ethernet adapter card with RJ-45 connector.
9. Open Bay = Authorized Assembler Program. See the note on page 192

Notes:

Parts (Type 6867)

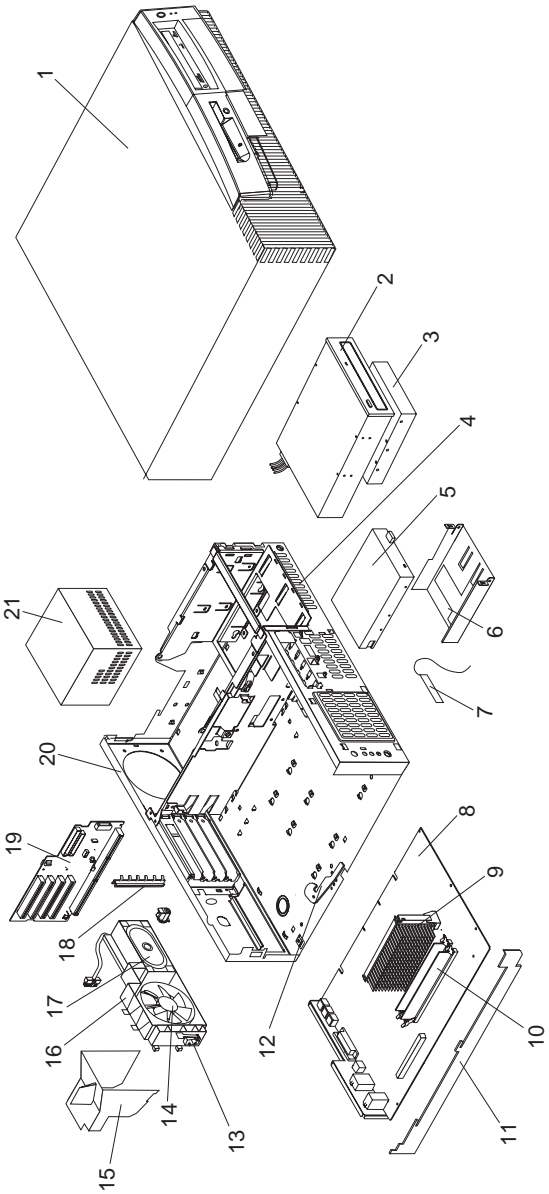

Parts listing

Index	System (Type 6867)	FRU No.
1	Top and Front Cover Assembly	33L2747
2	CD-ROM (48X Max)	09N0737
3	9.1 GB SCSI 7200RPM Hard Disk Drive	36L8648
3	13.5 GB EIDE Hard Disk Drive	36L8689
4	Hard drive Cage Latch Kit	33L2606
5	1.44 MB, 3.5-Inch Diskette Drive	75H9550
5	1.44 MB, 3.5-Inch Diskette Drive (Japan)	75H9552
6	3.5" Diskette Bracket	33L2599
7	RFID Antenna	03K9654
8	System Board (no processor, no memory)	01K2119
9	Pentium III Processor 600/133 MHz.	37L6034
9	Pentium III Processor 667/133 MHz.	00N3622
9	Pentium III Processor 733/133 MHz.	00N7174
10	Memory - 128 MB PC700 Memory RIMM, ECC	33L3108
10	Memory Continuity Card (C-RIMM)	00N5223
11	Side Bracket	03K9662
12	Latch, system board	03K9665
13	C2 Switch Assembly	33L2603
14	Fan 92mm with grommets	33L2594
15	Air Baffle	33L2593
16	Fan Bracket	33L2601
17	Speaker/Cable Assembly	37L5554
18	I/O Bracket	03K9622
19	Riser Card (PCI only)	28L4926
20	Chassis Assembly with latch	33L2602
21	Power Supply-145W	01K9846
21	Power Supply-145W (China)	36L8836
21	Power Supply-145W (Japan)	01K9848
	Bezel Kit	33L2746
	Cable - CD-ROM, IDE (1 drop)	33L2597
	Cable - Diskette Drive	33L2596
	Cable - Hard Disk, IDE	33L2595
	Cable - Wake On Ring	76H7345
	DASD EMC Shield Kit	33L2600
	Ethernet Adapter - Lake Clark 2.4	34L1109
	Foot (4)	33L2592
	Hard Drive Rails (Qty 2)	01K1539
	Keylock Assembly	02K1428
	LED/Power Switch Cable Assembly	20L3021
	Lithium Battery	33F8354
	Miscellaneous Hardware Kit	33L2605
	Mouse	28L1868
	Name Plate (6867)	33L2745
	RM Retainer Kit	33L4321
	Video card - Appian Gemini	09N0087
	Video card - IBM FIRE GL1 (AGP) 32 MB	37L2375
	Video Card - Matrox G400 (AGP) 16 MB	01N2197
	SCSI Adapter	10L7122
	SCSI Signal Cable (3-drop)	33L2598
	SCSI LED Cable Assembly	76H7344
	System Board Rails	03K9626

Keyboards - PCNext Lite

Arabic	37L2555
Belgian-French	37L2556
Belgian-UK	37L2557
Brazil/Portugal	37L2554
Bulgarian	37L2558
Chinese	37L2585
Czech	37L2559
Danish	37L2560
Dutch	37L2561
French	37L2562
French/Canadian-ID 058	37L0913
French/Canadian-ID 445	37L2552
German	37L2563
Greek	37L2564
Hebrew	37L2565
Hungarian	37L2566
Icelandic	37L2567
Italian	37L2568
Korean	28L1905
Japanese	37L2584
Latin/Spanish	37L2553
Norwegian	37L2569
Polish	37L2570
Portuguese	37L2571
Romania	37L2572
Russian	37L2573
Serbian/Cyrillic	37L2574
Slovakian	37L2575
Spanish	37L2576
Swed/Finn	37L2577
Swiss French/German	37L2578
Thailand	37L2587
Turkish (ID 179)	37L2579
Turkish (ID 440)	37L2580
UK English	37L2581
US English	37L2551
UK English (ISO Compliant)	37L2583
Yugoslavian	37L2582

Computer Power Cords

Arabic Countries	14F0033
Argentina	36L8880
Australia	93F2365
Belgium	1339520
Bulgaria	1339520
Canada	93F2364
Chile	14F0069
Czechoslovakia	1339520
Denmark	13F9997
Finland	1339520
France	1339520
Germany	1339520
Hungary	1339520
Israel	14F0087
Italy	14F0069
Latin-America	6952301
Netherlands	1339520
New Zealand	93F2365
Norway	1339520
Paraguay	36L8880
Poland	1339520
Portugal	1339520
Serbia	1339520
Slovakia	1339520
South Africa	14F0015
Spain	1339520
Switzerland	1339520
Switzerland (French, German)	14F0051
U.S.	93F2364
UK, Ireland	14F0033
Uruguay	36L8880
Yugoslavia	1339520

Display and Monitor Information

Display and monitor information is separately available and is listed under "Related publications" on page vi.

Special tools

The following tools are required to service these computers:

- A volt-ohm meter, IBM P/N 73G5404
- Wrap Plug, IBM P/N 72X8546

Related Service Information

Safety notices (multi-lingual translations)	202
Safety information	226
General safety	226
Electrical safety	227
Safety Inspection Guide	228
Handling electrostatic discharge-sensitive devices	230
Grounding requirements	230
Miscellaneous information	231
Send us your comments!	233
Do you need technical references?	234
Problem determination tips	235
File updates	236
Hardware considerations	236
Software considerations	237
BIOS	237
Drivers	237
Adding adapters to the system	238
System resource conflicts	238
Notices	242
Trademarks	243

Safety notices (multi-lingual translations)

The caution and danger safety notices in this section are provided in the following languages:

- English
- Brazilian/Portuguese
- Chinese
- French
- German
- Italian
- Korean
- Spanish



DANGER

To avoid a shock hazard, do not connect or disconnect any cables or perform installation, maintenance, or reconfiguration of this product during an electrical storm.

To avoid shock hazard:

- **The power cord must be connected to a properly wired and earthed receptacle.**
- **Any equipment to which this product will be attached must also be connected to properly wired receptacles.**

When possible, use one hand to connect or disconnect signal cables to prevent a possible shock from touching two surfaces with different electrical potentials.

Electrical current from power, telephone, and communications cables is hazardous. To avoid shock hazard, connect and disconnect cables as described following when installing, moving, or opening covers of this product or attached devices.

To Connect

1. Turn Everything OFF.
2. First, attach all cables to devices.
3. Attach signal cables to receptacles.
4. Attach power cord(s) to outlet.
5. Turn device ON.

To Disconnect

1. Turn Everything OFF.
2. First, remove power cord(s) from outlet.
3. Remove signal cables from receptacles.
4. Remove all cables from devices.

NOTE: In the UK, by law, the telephone cable must be connected after the power cord.

NOTE: In the UK, the power cord must be disconnected after the telephone cable.



Caution:

When replacing the battery, use only IBM Part Number 33F8354 or an equivalent type battery recommended by the manufacturer. If your system has a module containing a lithium battery, replace it only with the same module type made by the same manufacturer. The battery contains lithium and can explode if not properly used, handled, or disposed of.

Do not:

- Throw or immerse into water
- Heat to more than 100°C (212°F)
- Repair or disassemble

Dispose of the battery as required by local ordinances or regulations.



Caution:

When a CD-ROM drive is installed, note the following.

Use of controls or adjustments or performance of procedures other than those specified herein might result in hazardous radiation exposure.

Removing the covers of the CD-ROM drive could result in exposure to hazardous laser radiation. There are no serviceable parts inside the CD-ROM drive. Do not remove the CD-ROM drive covers.

DANGER

Some CD-ROM drives contain an embedded Class 3A or Class 3B laser diode. Note the following.

Laser radiation when open. Do not stare into the beam, do not view directly with optical instruments, and avoid direct exposure to the beam.



≥32 kg
(70.5 lbs)



≥55 kg
(121.2 lbs)

Caution:

Use safe lifting practices when lifting your machine.



Caution:

Electrical current from power, telephone, and communication cables can be hazardous. To avoid personal injury or equipment damage, disconnect the attached power cords, telecommunications systems, networks, and modems before you open the server covers, unless instructed otherwise in the installation and configuration procedures.



PERIGO

Para evitar choques elétricos, não conecte ou desconecte nenhum cabo, nem efetue instalação, manutenção ou reconfiguração deste produto durante uma tempestade com raios.

Para evitar choques elétricos:

- **O cabo de alimentação deve ser conectado a um receptáculo corretamente instalado e aterrado.**
- **Todos os equipamentos aos quais este produto será conectado devem também ser conectados a receptáculos corretamente instalados.**

Quando possível, utilize uma das mãos para conectar ou desconectar cabos de sinal, para evitar um possível choque ao tocar duas superfícies com potenciais elétricos diferentes.

A corrente elétrica proveniente de cabos de alimentação, de telefone e de comunicação é perigosa. Para evitar choques elétricos, conecte e desconecte os cabos conforme descrito a seguir, ao instalar, movimentar ou abrir tampas deste produto ou de dispositivos conectados.

Para Conectar

1. **DESLIGUE tudo.**
2. **Conecte primeiro todos os cabos nos dispositivos.**
3. **Conecte os cabos de sinal nos receptáculos.**
4. **Conecte o(s) cabo(s) de alimentação nas tomadas.**
5. **LIGUE o dispositivo.**

Para Desconectar

1. **DESLIGUE tudo.**
2. **Remova primeiro o(s) cabo(s) de alimentação das tomadas.**
3. **Remova os cabos de sinal dos receptáculos.**
4. **Remova todos os cabos dos dispositivos.**



cuidado:

Ao substituir a bateria, utilize apenas o Número de Peça IBM 33F8354 ou um tipo de bateria equivalente recomendado pelo fabricante. Se seu sistema possuir um módulo com uma bateria de lítio, substitua-o apenas pelo mesmo tipo de módulo, produzido pelo mesmo fabricante. A bateria contém lítio e pode explodir se não for utilizada, manuseada e descartada de forma adequada.

Não:

- Jogue ou coloque na água
- Aqueça a mais de 100°C (212°F)
- Conserte nem desmonte.

Descarte a bateria conforme requerido pelas disposições e regulamentações locais.



cuidado:

Quando uma unidade de CD-ROM estiver instalada, observe o seguinte.

A utilização de controles ou ajustes ou a execução de procedimentos diferentes daqueles especificados nesta publicação pode resultar em exposição perigosa à radiação.

A remoção das tampas da unidade de CD-ROM pode resultar em exposição a radiação perigosa de laser. Não existem peças que possam ser consertadas no interior da unidade de CD-ROM. Não remova as tampas da unidade de CD-ROM.

PERIGO

Algumas unidades de CD-ROM contêm um diodo de laser da Classe 3A ou da Classe 3B. Observe o seguinte.

Radiação de laser quando aberto. Não olhe diretamente para o feixe de laser, não olhe diretamente com instrumentos óticos, e evite exposição direta ao raio.



≥32 kg
(70,5 lbs)



≥55 kg
(121,2 lbs)

cuidado:

Utilize práticas seguras para levantamento de peso ao levantar sua máquina.



cuidado:

A corrente elétrica proveniente de cabos de alimentação, de telefone e de comunicação é perigosa. Para evitar ferimentos pessoais ou danos aos equipamentos, desconecte os cabos de alimentação, sistemas de telecomunicação, redes e modems antes de abrir as tampas do servidor, a menos que receba outras instruções nos procedimentos de instalação e configuração.

声明 1



危险!

为避免电击危险，请不要在暴风雨期间连接或断开任何电缆，或是进行此产品的安装、维护或重新配置操作。

为避免电击危险：

- 电源线必须连接到适当的电线及接地插座。
- 此产品将要连接的所有设备也必须连接到正确接线的插座上。

如果可能，请使用一只手连接或断开连接信号电缆，以避免在接触两个具有不同电势的表面时遭到电击。

电源线、电话线以及通信电缆中的电流非常危险。为避免电击，请在安装、移动或打开本产品或连接设备的外盖时，按照下述步骤连接或断开电缆。

要连接电缆

1. 关闭所有设备。
2. 首先将所有电缆与设备连接。
3. 将信号线连接到插座。
4. 将电源线连接到电源插座。
5. 打开设备。

要断开电缆

1. 关闭所有设备。
2. 首先从电源插座拔下电源线。
3. 从插座拔下信号电缆。
4. 从设备上拔下所有电缆。

声明 2



注意!

当更换电池时，仅可使用 IBM 部件号为 33F8354 的产品或由制造商推荐的同等电池。如果系统中有包含锂电池的模块，则只能使用由相同制造商制造的相同类型模块更换。该电池含有锂，如果使用、操作或处理不当会发生爆炸。

不要：

- 将其投入或浸于水中
- 加热超过100°C (212°F)
- 修理或拆卸

应按照当地法规和条例对此电池进行处理。

声明 3



注意!

在已安装 CD-ROM 驱动器的情况下，请注意下面的内容。

不遵循此处指定的控制、调整、或操作过程的操作将可能导致危险的辐射泄漏。

取下 CD-ROM 驱动器的外盖会导致危险的激光辐射泄漏。CD-ROM 驱动器内没有可以使用的部件。请不要取下 CD-ROM 驱动器的外盖。

声明 4

危险！

一些 CD-ROM 驱动器中包含内置的 3A 类或 3B 类激光二极管。
请注意下述内容。

打开驱动器会产生激光辐射。请不要凝视激光束，请不要使用光学仪器直接观看激光束，同时也要避免人体直接暴露在激光束下。

声明 5



32 kg (70.5 磅)



55 kg (121.2 磅)

注意！

搬运机器时，请进行安全搬运操作。

声明 10



注意！

电源线、电话线以及通信电缆中的电流非常危险。为避免人身伤害或设备损坏，除非在安装和配置过程中特别指明，请在打开服务器外盖前断开已连接的全部电源线、电信系统、网络及调制解调器。

· 声明 1



危险

为了避免雷击，在闪电期间，请勿连接或拔掉本装置上的任何电缆线，或请勿安装、维修或重新架构本产品。

为了避免雷击：

- 电源线必须连接到接线及接地正确的插座。
- 本产品所连接的设备也必须连接到接线正确的插座。

儘可能使用单手来连接或拔掉信号电缆，以避免因接触两个不同电位的平面，而受到电击。

电源、电话及通信电缆上均有电流流通。为了避免电击，在安装、移动本产品，或开启本产品的盖子或与本产品连接之装置的盖子时，请依照下列「连接」及「拔掉」电缆线的步骤操作。

连接

1. 关掉所有开关。
2. 首先，将所有电缆线连接到装置。
3. 将信号电缆连接到信号插座。
4. 将电源线连接到电源插座。
5. 开启装置电源。

拔掉

1. 关掉所有开关。
2. 首先，自电源插座拔掉电源线。
3. 拔掉信号插座上的所有信号电缆。
4. 拔掉装置上的所有电缆线。

• 聲明 2



注意：

更換電池時，只可使用 IBM 零件編號 33F8354 的電池，或廠商建議的相當類型的電池。如您系統中的模組含有鋰電池，更換時，請使用相同廠商製造的相同模組類型。如未正常使用、處理或捨棄含有鋰的電池時，可能會造成爆炸。

嚴禁：.

- 丟入或浸入水中
- 加熱超過攝氏100度（華氏 212 度）
- 修補或拆解

處理廢棄電池時，請遵照當地法令規章處理。

• 聲明 3



注意：

安裝光碟機時，請注意下列事項：

不依此處所指示的控制、調整或處理步驟，恐有遭致輻射之虞。

移開光碟機蓋子，恐有遭致雷射輻射之虞。光碟機中沒有需要維修的部分。請勿移開光碟機的蓋子。

• 聲明 4



危險

光碟機含有內嵌式 Class 3A 或 Class 3B 雷射二極體時，請注意下列事項：

開啓時會產生雷射輻射。請勿凝視光束，不要使用光學儀器直接觀察，且應避免直接暴露在光束下。

• 聲明 5



≥ 32 公斤 (70.5 磅)



≥ 55 公斤 (121.2 磅)

注意：

提昇機器時，請使用安全提昇措施。

• 聲明 10



注意：

電源、電話及通信電纜上均有電流通過。在安裝及架構之時，若非專家指導，為了避免人員受傷、設備受損，在開啓伺服器蓋子之前，請切斷電源線、電信系統、網路及數據機。



PERIGO

Pour éviter tout risque de choc électrique, ne manipulez aucun câble et n'effectuez aucune opération d'installation, d'entretien ou de reconfiguration de ce produit au cours d'un orage.

Pour éviter tout risque de choc électrique :

- **Les cordons d'alimentation du présent produit et de tous les appareils qui lui sont connectés doivent être branchés sur des socles de prise de courant correctement câblés et mis à la terre.**

Afin d'éviter tout risque de choc électrique provenant d'une différence de potentiel de terre, n'utilisez qu'une main, lorsque cela est possible, pour connecter ou déconnecter les cordons d'interface.

Le courant électrique passant dans les câbles de communication, ou les cordons téléphoniques et d'alimentation peut être dangereux. Pour éviter tout risque de choc électrique, lorsque vous installez ou que vous déplacez le présent produit ou des périphériques qui lui sont raccordés, reportez-vous aux instructions ci-dessous pour connecter et déconnecter les différents cordons.

Connexion

1. Mettez les unités hors tension.
2. Commencez par brancher tous les cordons sur les unités.
3. Branchez les câbles d'interface sur les prises.
4. Branchez les cordons d'alimentation sur un socle de prise de courant.
5. Mettez les unités sous tension.

Déconnexion

1. Mettez les unités hors tension.
2. Commencez pas débrancher les cordons alimentation des socles de prise de courant.
3. Débranchez les câbles d'interface des prises.
4. Débranchez tous les câbles des unités.



attention:

Remplacez la pile usagée par une pile de référence identique exclusivement - voir la référence IBM - ou par une pile équivalente recommandée par le fabricant. Si votre système est doté d'un module contenant une pile au lithium, vous devez le remplacer uniquement par un module identique, produit par le même fabricant. La pile contient du lithium et présente donc un risque d'explosion en cas de mauvaise manipulation ou utilisation.

- Ne la jetez pas à l'eau.
- Ne l'exposez pas à une température supérieure à 100 °C.
- Ne cherchez pas à la réparer ou à la démonter.

Pour la mise au rebut, reportez-vous à la réglementation en vigueur.



attention:

Si une unité de CD-ROM est installée, prenez connaissance des informations suivantes :

Pour éviter tout risque d'exposition au rayon laser, respectez les consignes de réglage et d'utilisation des commandes, ainsi que les procédures décrites dans le présent document.

Pour éviter une exposition directe au rayon laser, n'ouvrez pas l'unité de CD-ROM. Vous ne pouvez effectuer aucune opération de maintenance à l'intérieur.

PERIGO

Certaines unités de CD-ROM contiennent une diode laser de classe 3A ou 3B. Prenez connaissance des informations suivantes :

Rayonnement laser lorsque le carter est ouvert. Évitez de regarder fixement le faisceau ou de l'observer à l'aide d'instruments optiques. Évitez une exposition directe au rayon.

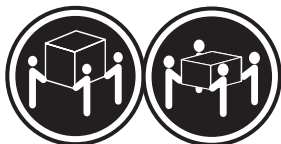

≥32 kg

≥55 kg

attention:

Ce produit pèse un poids considérable. Faites-vous aider pour le soulever.



attention:

Le courant électrique circulant dans les câbles de communication et les cordons téléphoniques et d'alimentation peut être dangereux. Pour votre sécurité et celle de l'équipement, avant de retirer les carters du serveur, mettez celui-ci hors tension et déconnectez ses cordons d'alimentation, ainsi que les câbles qui le relie aux réseaux, aux systèmes de télécommunication et aux modems (sauf instruction contraire mentionnée dans les procédures d'installation et de configuration).



VORSICHT

Aus Sicherheitsgründen bei Gewitter an diesem Gerät keine Kabel anschließen oder lösen. Ferner keine Installations-, Wartungs- oder Rekonfigurationsarbeiten durchführen.

Aus Sicherheitsgründen:

- **Gerät nur an eine Schutzkontaktsteckdose mit ordnungsgemäß geerdetem Schutzkontakt anschließen.**
- **Alle angeschlossenen Geräte ebenfalls an Schutzkontaktsteckdosen mit ordnungsgemäß geerdetem Schutzkontakt anschließen.**

Signalkabel möglichst einhändig anschließen oder lösen, um einen Stromschlag durch Berühren von Oberflächen mit unterschiedlichem elektrischem Potential zu vermeiden.

Elektrische Spannungen von Netz-, Telefon- und Datenübertragungsleitungen sind gefährlich. Um einen Stromschlag zu vermeiden, nur nach den Anweisungen arbeiten, die für Installation, Transport oder Öffnen von Gehäusen dieses Produkts oder angeschlossenen Einheiten gelten.

Kabel anschließen

1. Alle Geräte ausschalten und Netzstecker ziehen.
2. Zuerst alle Kabel an Einheiten anschließen.
3. Signalkabel an Anschlußbuchsen anschließen.
4. Netzstecker an Steckdose anschließen.
5. Gerät einschalten.

Kabel lösen

1. Alle Geräte ausschalten.
2. Zuerst Netzstecker von Steckdose lösen.
3. Signalkabel von Anschlußbuchsen lösen.
4. Alle Kabel von Einheiten lösen.



achtung:

Eine verbrauchte Batterie nur durch eine Batterie mit der IBM Teilenummer 33F8354 oder durch eine vom Hersteller empfohlene Batterie ersetzen. Wenn Ihr System ein Modul mit einer Lithium-Batterie enthält, ersetzen Sie es immer mit dem selben Modultyp vom selben Hersteller. Die Batterie enthält Lithium und kann bei unsachgemäßer Verwendung, Handhabung oder Entsorgung explodieren.

Die Batterie nicht

- mit Wasser in Berührung bringen.
- über 100 C erhitzen.
- reparieren oder zerlegen.

Die örtlichen Bestimmungen für die Entsorgung von Sondermüll beachten.



achtung:

Wenn ein CD-ROM-Laufwerk installiert ist, beachten Sie folgendes. Steuer- und Einstellelemente sowie Verfahren nur entsprechend den Anweisungen im vorliegenden Handbuch einsetzen. Andernfalls kann gefährliche Laserstrahlung auftreten.

Das Entfernen der Abdeckungen des CD-ROM-Laufwerks kann zu gefährlicher Laserstrahlung führen. Es befinden sich keine Teile innerhalb des CD-ROM-Laufwerks, die vom Benutzer gewartet werden müssen. Die Verkleidung des CD-ROM-Laufwerks nicht öffnen.

VORSICHT

Manche CD-ROM-Laufwerke enthalten eine eingebaute Laserdiode der Klasse 3A oder 3B. Die nachfolgend aufgeführten Punkte beachten.

Laserstrahlung bei geöffneter Tür. Niemals direkt in den Laserstrahl sehen, nicht direkt mit optischen Instrumenten betrachten und den Strahlungsbereich meiden.



≥32 kg



≥55 kg

achtung:

Beim Anheben der Maschine die vorgeschriebenen Sicherheitsbestimmungen beachten.



achtung:

An Netz-, Telefon- und Datenleitungen können gefährliche elektrische Spannungen anliegen. Um eine Gefährdung des Benutzers oder Beschädigung des Geräts zu vermeiden, ist der Server auszuschalten. Die Verbindung zu den angeschlossenen Netzkabeln, Telekommunikationssystemen, Netzwerken und Modems ist vor dem Öffnen des Servergehäuses zu unterbrechen (sofern in Installations- und Konfigurationsanweisungen nicht anders angegeben).



PERICOLO

Per evitare il pericolo di scosse elettriche durante i temporali, non collegare o scollegare cavi, non effettuare l'installazione, la manutenzione o la riconfigurazione di questo prodotto.

Per evitare il pericolo di scosse elettriche:

- **collegare il cavo di alimentazione ad una presa elettrica correttamente cablata e munita di terra di sicurezza;**
- **collegare qualsiasi apparecchiatura collegata a questo prodotto ad una presa elettrica correttamente cablata e munita di terra di sicurezza.**

Quando possibile, collegare o scollegare i cavi di segnale con una sola mano per evitare il rischio di scosse derivanti dal contatto con due superfici a diverso potenziale elettrico.

La corrente elettrica circolante nei cavi di alimentazione, del telefono e di segnale è pericolosa. Per evitare scosse elettriche, collegare e scollegare i cavi come descritto quando si effettuano l'installazione, la rimozione o l'apertura dei coperchi di questo prodotto o durante il collegamento delle unità.

Per collegare

1. **SPEGNERE** tutti i dispositivi.
2. Collegare prima tutti i cavi alle unità.
3. Collegare i cavi di segnale alle prese.
4. Collegare il(i) cavo(i) di alimentazione alla presa elettrica.
5. **ACCENDERE** le unità.

Per scollegare

1. **SPEGNERE** tutti i dispositivi.
2. Rimuovere prima il(i) cavo(i) di alimentazione dalla presa elettrica.
3. Rimuovere i cavi di segnale dalle prese.
4. Rimuovere tutti i cavi dalle unità.

**ATTENZIONE:**

Quando si sostituisce la batteria, utilizzare solo una batteria IBM o batterie dello stesso tipo o di tipo equivalente consigliate dal produttore. Se il sistema di cui si dispone è provvisto di un modulo contenente una batteria al litio, sostituire tale batteria solo con un tipo di modulo uguale a quello fornito dal produttore. La batteria contiene litio e può esplodere se utilizzata, maneggiata o smaltita impropriamente.

Evitare di:

- Gettarla o immergerla in acqua
- Riscaldarla ad una temperatura superiore ai 100° C
- Cercare di ripararla o smaltirla

Smaltire secondo la normativa in vigore (D.Lgs 22 del 5/2/97) e successive disposizioni nazionali e locali.

**ATTENZIONE:**

Quando è installata un'unità CD-ROM, notare quanto segue:

L'utilizzo di controlli, regolazioni o l'esecuzione di procedure non descritti nel presente manuale possono provocare l'esposizione a radiazioni pericolose.

L'apertura di un'unità CD-ROM può determinare l'esposizione a radiazioni laser pericolose. All'interno dell'unità CD-ROM non vi sono parti su cui effettuare l'assistenza tecnica. Non rimuovere i coperchi dell'unità CD-ROM.

PERICOLO

Alcune unità CD-ROM contengono all'interno un diodo laser di Classe 3A o Classe 3B. Prestare attenzione a quanto segue:

Aperto l'unità vengono emesse radiazioni laser. Non fissare il fascio, non guardarlo direttamente con strumenti ottici ed evitare l'esposizione diretta al fascio.



≥32 kg



≥55 kg

ATTENZIONE:

Durante il sollevamento della macchina seguire delle norme di di sicurezza.



ATTENZIONE:

La corrente circolante nei cavi di alimentazione, del telefono e di segnale è pericolosa. Per evitare situazioni pericolose per le persone o danneggiamenti all'apparecchiatura, scollegare i cavi di alimentazione, i sistemi di telecomunicazioni, le reti e ed i modem prima di aprire i coperchi del server se non diversamente indicato nelle procedure di installazione e configurazione.



위험

전기 충격을 피하려면 날씨가 나쁠 때(예: 눈 또는 비가 오거나 천둥 번개가 칠 때)는 케이블을 연결하거나 끊지 않도록 하고 이 제품의 설치, 유지보수 또는 재구성 등의 작업을 수행하지 않도록 하십시오.

전기 충격을 피하려면 다음과 같아야 합니다.

- 고압선은 적절한 배선 및 접지 상태의 콘센트로 연결되어야 합니다.
- 이 제품이 접속될 모든 장비도 적절한 배서 상태의 콘센트로 연결되어야 합니다.

다른 전위를 가진 두 표면을 만졌을 때 발생할 수 있는 전기 충격을 피하려면 한 손으로 신호선을 연결하거나 끊으십시오.

전원, 전화 및 통신 케이블로부터 흘러 나오는 전류는 위험합니다. 전기 충격을 피하려면 이 제품이나 접속 장치를 설치, 이동 및 덮개를 열 때 다음 설명에 따라 케이블을 연결하고 끊도록 하십시오.

연결하려면	연결해제하려면
1. 모든 스위치를 켜다.	1. 모든 스위치를 끈다.
2. 먼저 모든 케이블을 장치에 연결한다.	2. 먼저 모든 케이블을 장치에 제거한다.
3. 신호선을 콘센트에 연결한다.	3. 신호선을 콘센트에서 제거한다.
4. 전원을 콘센트에 연결한다.	4. 장치에서 모든 케이블을 제거한다.
5. 장치 스위치를 켜다.	



주의:

배터리를 교체할 때는 IBM 부품 번호 &PN. 또는 제조업체에서 추천하는 동등한 유형의 배터리를 사용하십시오. 시스템에 리튬 배터리를 포함하는 모듈이 있으면 이것은 동일한 제조업체에서 생산된 동일한 모듈 유형으로만 교체하십시오. 배터리에 리튬이 포함되어 있으므로 제대로 사용, 처리 또는 처분하지 않으면 폭발할 수 있습니다.

다음을 주의하십시오.

- 던지거나 물에 담그지 않도록 하십시오.
- 100°C(212°F) 이상으로 가열하지 않도록 하십시오.
- 수리하거나 분해하지 않도록 하십시오.

지역 법령이나 규정의 요구에 따라 배터리를 처분하십시오.



주의:

CD-ROM 드라이브가 설치되어 있으면 다음 사항을 명심하십시오.

여기에서 지정하지 않은 방식으로 CD-ROM 드라이브를 제거 또는 조절하거나 다른 절차로 사용하면 위험한 방사능 노출이 발생할 수 있습니다.

CD-ROM 드라이브의 덮개를 제거하면 위험한 레이저 방사능이 노출될 수 있습니다. CD-ROM 드라이브 내에는 정비할 수 있는 부품이 없습니다. CD-ROM 드라이브 덮개를 제거하지 않도록 하십시오.

위험

일부 CD-ROM 드라이브에는 클래스 3A 또는 3B 레이저 2극
진공관(다이오드)이 들어 있습니다. 다음 사항을 명심하십시오.

열면 레이저 방사능이 노출됩니다. 광선을 주시하거나 광학 기계를
직접 쳐다보지 않도록 하고 광선에 노출되지 않도록 하십시오.

경고문 5



32kg(70.5 파운드)



55kg(121.2 파운드)

주의:

기계를 들 때는 안전하게 들어 올리십시오.

경고문 10



주의:

전원, 전화 및 통신 케이블로부터 흘러 나오는 전류는 위험합니다. 설치 및 구성 절차에
다른 지시가 없으면, 다치거나 장비 손상이 생기지 않게 하기 위해 서버 덮개를 열기
전에 접속된 전선, 원격 통신 시스템, 네트워크 및 모뎀의 연결을 끊으십시오.



PELIGRO

Para evitar una posible descarga eléctrica, no conecte ni desconecte los cables ni lleve a cabo ninguna operación de instalación, de mantenimiento o de reconfiguración de este producto durante una tormenta eléctrica.

Para evitar una posible descarga:

- **El cable de alimentación debe conectarse a un receptáculo con una instalación eléctrica correcta y con toma de tierra.**
- **Los aparatos a los que se conecte este producto también deben estar conectados a receptáculos con la debida instalación eléctrica.**

Cuando sea posible, utilice una sola mano para conectar o desconectar los cables de señal a fin de evitar una posible descarga al tocar dos superficies con distinto potencial eléctrico.

La corriente eléctrica de los cables de comunicaciones, teléfono y alimentación puede resultar peligrosa. Para evitar una posible descarga, siga las indicaciones de conexión y desconexión de los cables siempre que tenga que instalar, mover o abrir las cubiertas de este producto o de los dispositivos acoplados.

Instrucciones de conexión

1. Apague todos los componentes (OFF).
2. En primer lugar, conecte todos los cables a los dispositivos.
3. Conecte los cables de señal a los receptáculos.
4. Conecte los cables de alimentación a las tomas.
5. Encienda el dispositivo (ON).

Instrucciones de desconexión

1. Encienda todos los componentes (ON).
2. En primer lugar, retire los cables de alimentación de las tomas.
3. Retire los cables de señal de los receptáculos.
4. Retire todos los cables de los dispositivos.



percaución:

Al cambiar la batería, utilice únicamente la batería IBM Número de pieza 33F8354 o un tipo de batería equivalente recomendado por el fabricante. Si el sistema tiene un módulo que contiene una batería de litio, sustitúyalo únicamente por el mismo tipo de módulo del mismo fabricante. La batería contiene litio y puede explotar si no se utiliza, manipula o desecha correctamente.

Lo que no debe hacer

- Tirar o sumergir el producto en agua.
- Exponer el producto a una temperatura superior a 100°C.
- Reparar o desmontar el producto.

Cuando quiera desechar la batería, siga las disposiciones y reglamentaciones locales.



percaución:

Cuando instale una unidad de CD-ROM, tenga en cuenta la siguiente información.

Si se llevan a cabo controles o ajustes o se utilizan métodos que no se atengan a lo aquí especificado, se puede producir una exposición peligrosa a las radiaciones.

Si se retiran las cubiertas de la unidad de CD-ROM, se puede producir una peligrosa exposición a radiaciones de láser. Dentro de la unidad de CD-ROM no existen piezas reparables. No retire las cubiertas de la unidad de CD-ROM.

PELIGRO

Algunas unidades de CD-ROM tienen incorporado un diodo de láser de Clase 3A o de Clase 3B. Tenga en cuenta la siguiente información.

Cuando la unidad está abierta se generan emisiones de rayos láser. No dirija la mirada al haz, no lo observe directamente con instrumentos ópticos y evite la exposición directa.



≥32 kg



≥55 kg

precaución:

Alce la máquina con cuidado; el sobrepeso podría causar alguna lesión.



precaución:

La corriente eléctrica de los cables de comunicaciones, de teléfono y de alimentación puede resultar peligrosa. Para evitar posibles lesiones o daños del aparato, desconecte los cables de alimentación, los sistemas de telecomunicaciones, las redes y los módems antes de abrir las cubiertas del servidor, salvo que se indique lo contrario en las instrucciones de las operaciones de instalación y configuración.

Safety information

The following section contains the safety information that you need to be familiar with before servicing an IBM mobile computer.

General safety

Follow these rules to ensure general safety:

- Observe good housekeeping in the area of the machines during and after maintenance.
- When lifting any heavy object:
 1. Ensure you can stand safely without slipping.
 2. Distribute the weight of the object equally between your feet.
 3. Use a slow lifting force. Never move suddenly or twist when you attempt to lift.
 4. Lift by standing or by pushing up with your leg muscles; this action removes the strain from the muscles in your back. *Do not attempt to lift any objects that weigh more than 16 kg (35 lb) or objects that you think are too heavy for you.*
- Do not perform any action that causes hazards to the customer, or that makes the equipment unsafe.
- Before you start the machine, ensure that other service representatives and the customer's personnel are not in a hazardous position.
- Place removed covers and other parts in a safe place, away from all personnel, while you are servicing the machine.
- Keep your tool case away from walk areas so that other people will not trip over it.
- Do not wear loose clothing that can be trapped in the moving parts of a machine. Ensure that your sleeves are fastened or rolled up above your elbows. If your hair is long, fasten it.
- Insert the ends of your necktie or scarf inside clothing or fasten it with a nonconductive clip, approximately 8 centimeters (3 inches) from the end.
- Do not wear jewelry, chains, metal-frame eyeglasses, or metal fasteners for your clothing.

Remember: Metal objects are good electrical conductors.

- Wear safety glasses when you are: hammering, drilling soldering, cutting wire, attaching springs, using solvents, or working in any other conditions that might be hazardous to your eyes.
- After service, reinstall all safety shields, guards, labels, and ground wires. Replace any safety device that is worn or defective.
- Reinstall all covers correctly before returning the machine to the customer.

Electrical safety

Observe the following rules when working on electrical equipment.

Important

Use only approved tools and test equipment. Some hand tools have handles covered with a soft material that does not insulate you when working with live electrical currents.

Many customers have, near their equipment, rubber floor mats that contain small conductive fibers to decrease electrostatic discharges. Do not use this type of mat to protect yourself from electrical shock.

- Find the room emergency power-off (EPO) switch, disconnecting switch, or electrical outlet. If an electrical accident occurs, you can then operate the switch or unplug the power cord quickly.
- Do not work alone under hazardous conditions or near equipment that has hazardous voltages.
- Disconnect all power before:
 - Performing a mechanical inspection
 - Working near power supplies
 - Removing or installing main units
- Before you start to work on the machine, unplug the power cord. If you cannot unplug it, ask the customer to power-off the wall box that supplies power to the machine and to lock the wall box in the off position.
- If you need to work on a machine that has *exposed* electrical circuits, observe the following precautions:
 - Ensure that another person, familiar with the power-off controls, is near you.

Remember: Another person must be there to switch off the power, if necessary.
 - Use only one hand when working with powered-on electrical equipment; keep the other hand in your pocket or behind your back.

Remember: There must be a complete circuit to cause electrical shock. By observing the above rule, you may prevent a current from passing through your body.
 - When using testers, set the controls correctly and use the approved probe leads and accessories for that tester.
 - Stand on suitable rubber mats (obtained locally, if necessary) to insulate you from grounds such as metal floor strips and machine frames.

Observe the special safety precautions when you work with very high voltages; these instructions are in the safety sections of maintenance information. Use extreme care when measuring high voltages.

- Regularly inspect and maintain your electrical hand tools for safe operational condition.
- Do not use worn or broken tools and testers.
- *Never assume* that power has been disconnected from a circuit. First, *check* that it has been powered-off.
- Always look carefully for possible hazards in your work area. Examples of these hazards are moist floors, nongrounded power extension cables, power surges, and missing safety grounds.
- Do not touch live electrical circuits with the reflective surface of a plastic dental mirror. The surface is conductive; such touching can cause personal injury and machine damage.
- Do not service the following parts *with the power on* when they are removed from their normal operating places in a machine:
 - Power supply units
 - Pumps
 - Blowers and fans
 - Motor generators

and similar units. (This practice ensures correct grounding of the units.)

- If an electrical accident occurs:
 - **Use caution; do not become a victim yourself.**
 - **Switch off power.**
 - **Send another person to get medical aid.**
- Asset ID allows the computer to be scanned by various radio frequency emitting devices supplied by independent companies. Asset ID is intended for use only with radio frequency equipment that meets ANSI/IEEE C95.1 1992 RF Radiation Limits.

Safety Inspection Guide

The intent of this inspection guide is to assist you in identifying potentially unsafe conditions on these products. Each machine, as it was designed and built, had required safety items installed to protect users and service personnel from injury. This guide addresses only those items. However, good judgment should be used to identify potential safety hazards due to attachment of non-IBM features or options not covered by this inspection guide.

If any unsafe conditions are present, you must determine how serious the apparent hazard could be and whether you can continue without first correcting the problem.

Consider these conditions and the safety hazards they present:

- Electrical hazards, especially primary power (primary voltage on the frame can cause serious or fatal electrical shock).

- Explosive hazards, such as a damaged CRT face or bulging capacitor
- Mechanical hazards, such as loose or missing hardware

The guide consists of a series of steps presented in a checklist. Begin the checks with the power off, and the power cord disconnected.

Checklist:

1. Check exterior covers for damage (loose, broken, or sharp edges).
2. Power-off the computer. Disconnect the power cord.
3. Check the power cord for:
 - a. A third-wire ground connector in good condition. Use a meter to measure third-wire ground continuity for 0.1 ohm or less between the external ground pin and frame ground.
 - b. The power cord should be the appropriate type as specified in the parts listings.
 - c. Insulation must not be frayed or worn.
4. Remove the cover.
5. Check for any obvious non-IBM alterations. Use good judgment as to the safety of any non-IBM alterations.
6. Check inside the unit for any obvious unsafe conditions, such as metal filings, contamination, water or other liquids, or signs of fire or smoke damage.
7. Check for worn, frayed, or pinched cables.
8. Check that the power-supply cover fasteners (screws or rivets) have not been removed or tampered with.

Handling electrostatic discharge-sensitive devices

Any computer part containing transistors or integrated circuits (ICs) should be considered sensitive to electrostatic discharge (ESD). ESD damage can occur when there is a difference in charge between objects. Protect against ESD damage by equalizing the charge so that the machine, the part, the work mat, and the person handling the part are all at the same charge.

Notes:

1. Use product-specific ESD procedures when they exceed the requirements noted here.
2. Make sure that the ESD protective devices you use have been certified (ISO 9000) as fully effective.

When handling ESD-sensitive parts:

- Keep the parts in protective packages until they are inserted into the product.
- Avoid contact with other people.
- Wear a grounded wrist strap against your skin to eliminate static on your body.
- Prevent the part from touching your clothing. Most clothing is insulative and retains a charge even when you are wearing a wrist strap.
- Use the black side of a grounded work mat to provide a static-free work surface. The mat is especially useful when handling ESD-sensitive devices.
- Use the ESD ground cord, FRU 25F9727, to protect the computer against ESD.
- Select a grounding system, such as those listed below, to provide protection that meets the specific service requirement.

Note: The use of a grounding system is desirable but not required to protect against ESD damage.

- Attach the ESD ground clip to any frame ground, ground braid, or green-wire ground.
- Use an ESD common ground or reference point when working on a double-insulated or battery-operated system. You can use coax or connector-outside shells on these systems.
- Use the round ground-prong of the AC plug on AC-operated computers.

Grounding requirements

Electrical grounding of the computer is required for operator safety and correct system function. Proper grounding of the electrical outlet can be verified by a certified electrician.

Miscellaneous information

Acronyms, Abbreviations and Terms

Term	Information
ACPA/A	Audio Capture and Playback Adapter
ADP	Automatic Data Processing
AGP	Advanced Graphics Port
Alt	Alternate
ANSI	American National Standards Institute
ARTIC	A Real Time Interface Coprocessor
ASCII	American National Standard Code for Interface Interchange
AT	Advanced Technology (as in AT Bus)
AVC	Audio Video Connection
BIOS	Basic Input/Output System (Controls System Resources)
bps	Bits Per Second
BPS	Bytes Per Second
CCITT	The International Telephone and Telegraph Consultative Committee
CCS	Common Command Set
CCSB	Common Complete Status Block
CCSB	Configuration Control Sub Board
CD	Compact Disc
CDPD	Cellular Digital Packet Data
CD-ROM	CD Read Only Memory (stores data/audio)
CGA	Color Graphics Adapter (See EGA, VGA, XGA)
CRC	Cyclic Redundancy Check
CRT	Cathode Ray Tube
CSA	Canadian Standards Association
CSD	Corrective Service Diskette
DASD	Direct Access Storage Device (hard disk, diskette)
DMA	Direct Memory Access
DRAM	Dynamic Random Access Memory
ECA	Engineering Change Announcement
ECC	Error Correction Code
EGA	Enhanced Graphics Adapter
ESD	Electrostatic Discharge
ESDI	Enhanced Small Device Interface
EEPROM	Electrically Erasable Programmable Read Only Memory
EWS	Energy Work Station
FRU	Field Replaceable Unit (replaceable part)
GPIB	General Purpose Interface Bus (IEEE 348)
GSA	General Services Administration
Ht	Height
IDE	Integrated Drive Electronics
IC	Integrated Circuit
IEEE	Institute of Electrical and Electronics Engineers
IEC	International Electrotechnical Commission
IML	Initial Machine Load
IPL	Initial Program Load
ISA	Industry Standard Architecture
ISO	International Organization for Standardization
ISDN	Integrated-Services Digital Network
LAN	Local Area Network
LBA	Local Block Address
LTB	Local Transfer Bus
LUN	Logical Unit Number (as in SCSI)
MAP	Maintenance Analysis Procedure

Term	Information
MCGA	Modified Color Graphics Adapter (320 x 200 x 256)
MCA	Micro Channel Architecture (bus structure)
MHz	Mega Hertz (million cycles per second)
MIDI	Musical Instrument Digital Interface
MM	Multimedia
N/A	Not Available or Not Applicable
NDD	National Distribution Division
NDIS	Network Driver Interface Specification
NMI	Non-Maskable Interrupt
NSC	National Support Center
NVRAM	Non Volatile Random Access Memory
OEM	Original Equipment Manufacturer
PCI	Peripheral component interconnect
PCMCIA	Personal Computer Memory Card International Association
POS	Programmable Option Select
PUN	Physical Unit Number (as in SCSI)
RAID	Redundant Array of Inexpensive Disks (disk array models)
RAM	Random Access Memory (read/write)
RGB	Red Green Blue (as in monitors)
RIPL	Remote Initial Program Load
ROM	Read Only Memory
SASD	Sequential Access Storage Device (Tape)
SCB	Subsystem Control Block
SCSI	Small Computer Systems Interface
SCSI ID	SCSI Identification Number (assigned device number)
SPD	Software Product Description
SR	Service Representative
SRAM	Static Random Access Memory
SVGA	Super Video Graphics Array
STN	Super Twisted Nematic
T/A	NDD Technical Advisor (See your Marketing Representative)
TDD	Telecommunications Device for the Deaf
TFT	Thin-Film Transistor
TPF	ThinkPad File
TSR	Terminate and Stay Resident
UL	Underwriters Laboratory
VCA	Video Capture Adapter
VESA	Video Electronics Standards Association
VGA	Video Graphics Array (640x480x16)
VPD	Vital Product Data
VRAM	Video Random Access Memory
WORM	Write Once, Read Many Media
XGA	Extended Graphics Array (1024 x 768 x 256)
Y/C	Luminance/Chrominance Signal (Video)

Send us your comments!

We want to know your opinion about this manual (part number 09N8603). Your input will help us to improve our publications.

Please photocopy this survey, complete it, and then fax it to **IBM HMM Survey** at **919-543-8167 (USA)**.

Name _____

Phone Number _____

1. Do you like this manual?
_____ Yes _____ No

2. What would you like to see added, changed, or deleted in this manual?

3. What is your service experience level?
_____ Less than five years
_____ More than five years

4. Which computers do you service most?

Thanks in advance for your response!

Do you need technical references?

We have a wide range of hardware technical references that provide in-depth information about IBM personal computer products. Our Technical Reference Library includes information about:

- Micro Channel, Setup, and Subsystem Control Block architectures
- Common interfaces (including microprocessors, system timers, parallel and serial port controllers, keyboards and keystrokes, SCSI, DMA, video, and more)
- Specific Personal System/2 systems (including system board connectors, jumpers, memory subsystems, I/O subsystems, programming interfaces and registers, and error codes)
- Basic input/output system (BIOS)
- Options and adapters

Note

Technical information manuals for the latest Commercial Desktop computers are available on the World Wide Web at:

<http://www.ibm.com/pc/us/cdt/hmm.html>

These publications can be viewed online in BookManager format, or they can be downloaded as PostScript files.

Problem determination tips

Due to the variety of hardware and software combinations that can be encountered, use the following information to assist you in problem determination.

- Verify any recent hardware changes. See “Hardware considerations” on page 236.
- Verify any recent software changes. See “Software considerations” on page 237.
- Verify the BIOS is at the latest level. See “BIOS” on page 237.
- Verify the drivers are at latest levels. See “Drivers” on page 237.
- Verify the Configuration matches hardware. See “System resource conflicts” on page 238.
- Verify the Diagnostic diskette is at latest level. See “File updates” on page 236.

As you go through problem determination, consider these questions:

- Do diagnostics fail?
- What, when, where, single, or multiple systems?
- Is the failure repeatable?
- Has this configuration ever worked?
- If it has been working, what changes were made prior to it failing?
- Is this the original reported failure?

Important

To eliminate confusion, systems are considered *identical* only if they:

1. Are the exact machine type and model
2. Have the same BIOS level
3. Have the same adapters/attachments in the same locations
4. Have the same address jumpers/terminators/cabling
5. Have the same software versions and levels
6. Have the same Reference/Diagnostics Diskette (version)
7. Have the same configuration options set in the system
8. Have the same setup for the operation system control files

Comparing the configuration and software set-up between “working and non-working” systems will often lead to problem resolution.

File updates

Use the World Wide Web (WWW) to download Diagnostic, BIOS Flash, and Device Driver files.

For PC Series 300/700 and IntelliStation systems, the WWW address is:

<http://www.pc.ibm.com/us/files.html>

For IBM PC Servers, the WWW address is:

<http://www.pc.ibm.com/us/servers/>

Hardware considerations

Use the following tools to help identify and resolve hardware-related problems:

- Power-on self-test (POST)
- POST Beep codes
- Test programs
- Error messages

POST does the following:

- Checks some basic system board operations
- Checks the memory operation
- Starts the video operation
- Verifies that the diskette drive is working
- Verifies that the hard disk drive is working

Use the test programs that come with this HMM or with the system you are servicing to test the IBM components of the system and some external devices. Also, from the DOS command or from OS/2 Utilities, use the **CHKDSK** command to check and repair hard disk data allocation errors.

Error messages generated by the software, (the operating system or application programs), generally are text messages, however, error messages can be text, numeric, or both text and numeric.

Any time there is an error message indicating a problem with the system, follow the General Checkout procedures in this HMM to resolve the problem.

Basically, there are five types of error messages:

- **POST error messages** are displayed when the POST finds problems with the hardware or detects a change in the hardware configuration.
- **POST Beep codes** are sounds emitted from the speaker if the POST finds a problem. One beep indicates the POST completed successfully. Multiple beeps indicate a problem was found.
- **Diagnostic error messages** are displayed when a test program finds a problem with a hardware component.

- **Software-generated error messages** are displayed if a problem or conflict is found by an application program, the operating system, or both. For an explanation of these messages, refer to the information supplied with the installed software package. Also, refer to “Software considerations.”
- **Multiple messages** occur when the first error causes additional errors. Follow the suggested action of the first error displayed.

Software considerations

Suspect a software failure if:

- Hardware diagnostics run error-free.
- Swapping hardware components fails to isolate the problem.

A software problem might be the result of a **mismatch between the hardware and the operating system device drivers or direct drivers.**

BIOS: The BIOS acts as an **interface between the system hardware, application software, and the operating system.**

BIOS contains the instructions to operate the basic system components:

- Keyboard
- Serial and parallel ports
- Diskette drive
- Hard disk drive
- VGA display
- Clock
- Memory controller

The BIOS then starts the IPL or Boot functions.

Drivers: Device drivers are the **BIOS for additional hardware.** Device drivers are the communicators of the hardware assignments to the operating system, including:

- IRQ level
- DMA channel
- I/O address
- ROM or RAM

Some device drivers like HIMEM.SYS are position sensitive and must be placed before other device drivers in the CONFIG.SYS file.

All device drivers are not found in the CONFIG.SYS file. Advanced operating systems use .INI files to setup and start devices.

Device drivers can access the hardware five ways.

- **Operating system direct to hardware using a direct driver.** Direct drivers, which bypass BIOS,

have the advantage of faster throughput, but the disadvantage of limited error-handling capability and reduced software and hardware compatibility and flexibility. This method is not used in the IBM PC Series systems.

- **Operating system to BIOS to hardware.** This is the recommended way. It's the most flexible because it's independent of the hardware.
- **Applications to operating system to BIOS to hardware.** This method is inflexible and operating system dependent.
- **Applications to BIOS to hardware.** This method has some flexibility but it is BIOS dependent.
- **Applications to hardware.** This method is hardware dependent and very inflexible, however, it is very fast, very efficient, and it has no overhead.

Adding adapters to the system

When adapters are added to the system, an area in memory has to be allocated to run its programs. This can be done with either **hardware switches or software mapping**.

If there is a conflict in software mapping:

- The first device to attach to an IRQ, DMA, I/O Address, or RAM location will probably function. The second device will not be found.
- Standalone diagnostics might function properly because the device that was found is the only device running.

Software configuration conflicts occur when:

- Hardware is configured differently than the software using it expects it to be.
- Hardware memory address space is in conflict with memory used by the application software.

System resource conflicts

System failures occur when there are system resource conflicts with the:

- Interrupt Request Queue (IRQ)
- Direct Memory Access (DMA)
- I/O Address
- ROM and RAM Addresses

IRQ:

- Assigns a unique interrupt request line to every I/O device (line numbers range from 0 to 15).
- Interrupts the processor to force it to service the request.
- Handles interrupts on a priority basis (low numbers have the highest priority).
- Queues interrupt request.

IRQ conflicts occur when there are **multiple assignments to the same interrupt level**. If there is an IRQ conflict, the system will hang. Use the systems diagnostics to check for multiple assignments to the same interrupt level before replacing any hardware component.

DMA:

- **Accesses the memory by bypassing the processor**, which allows the processor more time for applications and programs.
- Accesses memory directly from the serial and parallel ports on some systems.
- **Accesses memory directly from some adapters using a DMA channel**, which allows the adapter to operate faster.
- **Provides from 4 to 15 DMA channels**, the number varies depending on the system.

If **multiple assignments of the same DMA channel** occur, the system will hang. Use the system diagnostics to check for multiple assignments to the same DMA channel before replacing any hardware components.

I/O Address:

A unique I/O address is assigned to each system component.

If multiple assignments of the same I/O address occur, the system will hang. Use the **DOS MEM** command to check for multiple assignments to the **same** I/O address before replacing any hardware component.

ROM and RAM Addresses:

Adapter cards with processors can contain RAM and ROM. If the adapter cards have onboard memory, the:

- ROM contains operating instructions for the adapter I/O.
- RAM is used for buffering.

Two adapters using the same memory area will cause a failure. This failure might appear as a hardware failure.

The IRQ levels, DMA channels, I/O address, and ROM and RAM addresses all become potential conflicts and system problems. When conflicts arise, they might show up as system hangs, lost or missing devices, incorrect or bad data, or failing diagnostics. **Always eliminate conflicts in these areas before replacing any hardware components.**

U.S. Authorized Dealers or Servicers

Number	Information
800-528-7705	Bulletin Board Service - TSS Only
800-937-3737	IBM Business Partner Education
800-426-2472	IBM Customer Engineer Technical Support
800-IBM-DEAL	IBM Dealer Support Center
800-342-6672	IBM Direct Desktop Software Sales
303-924-4015	IBM Part Number ID and Look Up
800-426-7763	IBM PC HelpCenter
800-237-5511	IBM Software Defect Support (CSDs)
800-327-5711	IBM Software Ordering (Publications)
800-426-1484	IBM Supplies Technical Hotline
800-388-7080	IBM Warranty Parts Claims Center

U.S. Customers and Helpware Subscribers

Number	Information
800-426-8322	Customer Education Business Unit
800-999-0052	Customized Operational Services
800-237-4824	EduQuest (Educational Computers)
800-964-8523	End User HelpDesk Support
800-742-2493	IBM Anti-Virus Services
800-447-4700	IBM Authorized Dealer Referrals
800-426-2468	IBM Dealer Referral
800-426-3333	IBM Information Referral Service
800-IBM-SERV	IBM Service
800-772-2227	IBM PC HelpCenter and HelpDesk
800-426-7282	IBM Technical Manuals
800-426-9402 (Ext. 150)	Multimedia Information Center
800-241-1620	Multimedia HelpCenter
800-342-6672	OS/2 Information Line
800-237-5511	OS/2 Support Services
800-284-5933	Prodigy
914-962-0310	Prodigy User Questions
800-547-1283	Technical Coordinator Program
	SystemXtra for Personal Systems
	LAN Automated Distribution/2
	OS/2 Bulletin Board
	OS/2 Application Assistance Center
800-551-2832	Technical Solutions Magazine

Note

Calls from outside the U.S. will be charged international call rates.

IBM Canada Customer and Servicer Support

Number	Information
800-661-PSMT 905-316-5556	Business Partner Marketing Support Business Partner Marketing Support - Toronto
514-938-6048	Business Partner Marketing Support - French
800-465-4YOU	Customer Relations
800-IBM-SERV	Customer Service Dispatch
800-263-2769	Customer Service Parts
800-465-2222	Customer Support Center (ISC)
416-443-5701	Customer Service Repair Centre
800-505-1855	Dealer Support Group (DSG)
800-465-7999	HelpClub Registration / IBM Direct
800-565-3344	HelpPC
905-513-3355	IBM Certification Administrator Mail to: 50 Acadia Drive Markham, Ontario L3R 0B3
800-661-2131	IBM Education (A+ Course)
800-268-3100	IBM Information Network Support
800-387-8343	IBM PC Service Partners
800-487-7426	International Warranty Registration
800-663-7662	Lexmark Product Information
800-IBM-9990	PartnerLine
800-263-2769	Parts Orders, Exchange or Emergency
416-443-5808 (Fax)	Parts Regular Orders, Exchange
416-443-5755	Parts Orders, Inquiries
514-938-3022	PC Co Bulletin Board - Montreal
905-316-4255	PC Co Bulletin Board - Markham
604-664-6464	PC Co Bulletin Board - Vancouver
204-934-2735	PC Co Bulletin Board - Winnipeg
800-661-7768	PS Marketing Support (PSMT)
800-565-3344	PS/1 Warranty Customer Helpline
800-387-8483	PS/1 Warranty Service (DOAs)
800-465-1234	Publications Ordering
905-316-4148	Service Management Support
905-316-4100 (Fax)	Service Management Support
905-316-4150	Service (Warranty) Manager
905-316-4100 (Fax)	Service (Warranty) Manager
905-316-4872	Service Quality Programs
905-316-4100 (Fax)	Service Quality Programs
800-661-2131	Skill Dynamics (Education)
800-565-3344	ThinkPad EasyServe
416-443-5835 (Fax)	Warranty Claim Fulfillment
905-316-2445	Warranty Claim Reimbursement
905-316-3515 (Fax)	Warranty Claim Reimbursement
416-443-5778	Warranty Claim Parts Inquiry
800-505-1855	Warranty Provider Support Hotline
800-267-7472	Warranty Service, ThinkPad

Notices

References in this publication to IBM products, programs, or services do not imply that IBM intends to make these available in all countries in which IBM operates. Any reference to an IBM product, program, or service is not intended to state or imply that only that IBM product, program, or service may be used. Subject to IBM's valid intellectual property or other legally protectable rights, any functionally equivalent product, program, or service may be used instead of the IBM product, program, or service. The evaluation and verification of operation in conjunction with other products, except those expressly designated by IBM, are the responsibility of the user.

IBM may have patents or pending patent applications covering subject matter in this document. The furnishing of this document does not give you any license to these patents. You can send license inquiries, in writing, to:

IBM Director of Licensing
IBM Corporation
North Castle Drive
Armonk, NY 10504-1785
U.S.A.

Trademarks

The following terms are trademarks of the International Business Machines Corporation in the United States and/or other countries:

Aptiva	Asset ID	AT
BookManager	Business Partner	EduQuest
FaxConcentrator	HelpCenter	HelpClub
HelpFax	HelpWare	IBM
IntelliStation	Micro Channel	NetView
OS/2	PC 300	PC 700
Personal System/2	Portmaster	PS/1
PS/2	PS/ValuePoint	Rapid Resume
SelectaSystem	Skill Dynamics	SystemView
SystemXtra	ThinkPad	TrackPoint
TrackPoint II	Wake on LAN	XGA

ActionMedia, Celeron, LANDesk, MMX, Pentium, and ProShare are trademarks or registered trademarks of Intel Corporation in the U.S. and other countries.

Microsoft, Windows, Windows NT, and the Windows logo are registered trademarks of Microsoft Corporation.

Other company, product, and service names used in this publication may be trademarks or service marks of others.



Part Number: 09N8603

Printed in U.S.A.

S09N-8603-00

