

Personal Computer

Using Your Personal Computer

PC 300PL

Personal Computer

Using Your Personal Computer

PC 300PL



Note

Before using this information and the product it supports, be sure to read the general information under Appendix B, "Product Warranties, License Information, and Notices" on page 111.

Second Edition (July 1997)

The following paragraph does not apply to the United Kingdom or any country where such provisions are inconsistent with local law: INTERNATIONAL BUSINESS MACHINES CORPORATION PROVIDES THIS PUBLICATION "AS IS" WITHOUT WARRANTY OF ANY KIND, EITHER EXPRESS OR IMPLIED, INCLUDING, BUT NOT LIMITED TO, THE IMPLIED WARRANTIES OF MERCHANTABILITY OR FITNESS FOR A PARTICULAR PURPOSE. Some states do not allow disclaimer of express or implied warranties in certain transactions, therefore, this statement may not apply to you.

This publication could include technical inaccuracies or typographical errors. Changes are periodically made to the information herein; these changes will be incorporated in new editions of the publication. IBM may make improvements and/or changes in the product(s) and/or the program(s) described in this publication at any time.

This publication was developed for products and services offered in the United States of America. IBM may not offer the products, services, or features discussed in this document in other countries, and the information is subject to change without notice. Consult your local IBM representative for information on the products, services, and features available in your area.

Requests for technical information about IBM products should be made to your IBM reseller or IBM marketing representative.

© Copyright International Business Machines Corporation 1997. All rights reserved.

Note to U.S. Government Users — Documentation related to restricted rights — Use, duplication or disclosure is subject to restrictions set forth in GSA ADP Schedule Contract with IBM Corp.

Contents

Safety Information	v
Laser Compliance Statement	vi
Lithium Battery Notice	vii
About This Book	ix
Related Publications	x
Chapter 1. Your IBM Personal Computer	1
What Your IBM Personal Computer Offers	2
Microprocessor	2
System Memory	2
L2 Cache	2
ISA Bus	2
PCI Bus	2
Expansion with Adapters	3
High-Capacity Hard Disk Drives	3
CD-ROM Drive	3
ECP/EPP Parallel Port	4
Serial Ports	4
Universal Serial Bus Ports	4
Infrared Port (Optional)	5
Integrated Video Graphics Controller	5
Integrated Audio Controller	5
Integrated Ethernet Controller	5
System-Management Features	6
IBM-Preinstalled Software	6
Operating-System Support	6
Ease-of-Use Features	6
Ergonomic Features	7
Advanced Power Management	7
Asset Security Features	7
Service and Support	8
Expandability	9
Connectivity	10
Features at a Glance	11
System Specifications	15
Chapter 2. Arranging Your Workspace	17
Comfort	17
Glare and Lighting	18

Air Circulation	18
Electrical Outlets and Cable Lengths	18
Chapter 3. Operating Your Personal Computer	19
Using Controls and Status Indicators	19
Starting Your Personal Computer	20
Using a Mouse	21
Shutting Down	22
Using Video Features	22
Video Device Drivers	23
Video Options	23
Using Audio Features	24
Using System-Management Features	25
System Programs	26
Using a CD-ROM Drive	28
Handling a CD	29
Loading a CD	29
Using Security Features	31
Chapter 4. Configuring Your Computer	33
Using the Configuration/Setup Utility Program	33
Starting the Configuration/Setup Utility Program	34
Viewing and Changing Settings in the Configuration/Setup Utility Program	36
Exiting from the Configuration/Setup Utility Program	37
Viewing the System Summary	38
Setting the Date and Time	39
Changing Plug and Play Control Features	39
Passwords	40
Power-On Password	40
Administrator Password	44
Enhanced Security	47
Enabling and Disabling Enhanced Security	48
Setting, Changing, and Deleting an Administrator Password Protected by Enhanced Security	49
Erasing a Lost or Forgotten Administrator Password Protected by Enhanced Security	49
Advanced Power Management	49
Automatic Hardware Power Management Features	50
Automatic Power-On Features	51
System-Management Settings	52
Ethernet Support	53
RPL and DHCP	53
Automatic Power-On Startup Sequence	54

Wake on LAN	54
Update POST/BIOS from Network	55
Chapter 5. Taking Care of Your Computer	57
Basics	57
Cleaning Your Computer	57
Computer and Keyboard	57
Monitor Screen	57
Mouse	58
Replacing the Battery	59
Moving Your Computer	59
Chapter 6. Solving Problems	61
Using Diagnostic Tools	61
Power-On Self-Test (POST)	62
Error Messages	63
POST Message Charts	67
Troubleshooting Charts	85
Diagnostic Programs	95
Installing Files from Option Diskettes	96
Managing TSR Programs (DOS or Microsoft Windows 3.1x)	96
Error Messages Specific to the Integrated Ethernet	97
RPL-Related Error Messages	97
DHCP-Related Error Messages	98
Chapter 7. Getting Help, Service, and Information	99
Before You Call for Service	99
Getting Customer Support and Service	100
Using Electronic Support Services	100
Using the World Wide Web	101
Getting Information by Fax	101
Getting Help Online	102
Getting Help by Telephone	102
Getting Help Around the World	103
Purchasing Additional Services	103
Enhanced PC Support Line	103
900-Number Operating System and Hardware Support Line	104
Network and Server Support Line	104
Ordering Support Line Services	104
Warranty and Repair Services	105
Ordering Publications	106
Appendix A. Computer Records	107

Serial Numbers and Keys	107
Device Records	109
Appendix B. Product Warranties, License Information, and Notices	111
Hardware Limited Warranty	111
License Information	114
Program Name	114
Additional Terms and Conditions	114
Program Services	114
Warranty	115
U.S. Government Users Restricted Rights	115
Other Documentation	115
Other Additional Terms and Conditions	115
Notices	117
Trademarks	117
Electronic Emission Notices	119
Telecommunication Notices	121
Power Cord Notice	123
Index	125

Safety Information



DANGER:

Electrical current from power, telephone, and communication cables is hazardous. To avoid shock hazard, connect and disconnect cables as shown below when installing, moving or opening the covers of this product or attached devices. The power cord must be used with a properly grounded outlet.

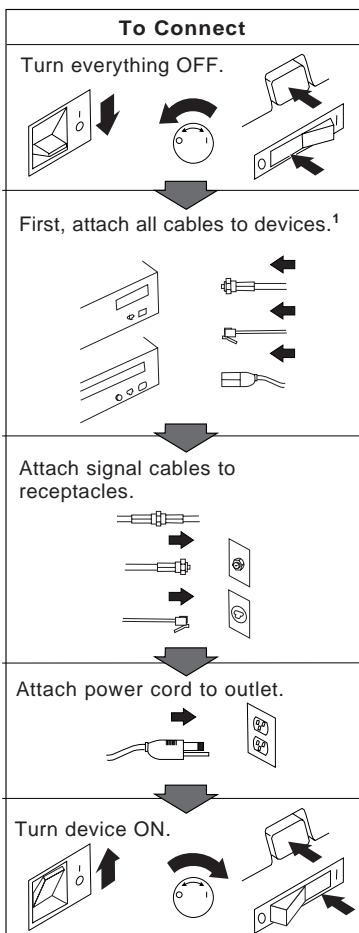

¹ In the U.K., by law, the telephone cable must be connected after the power cord.

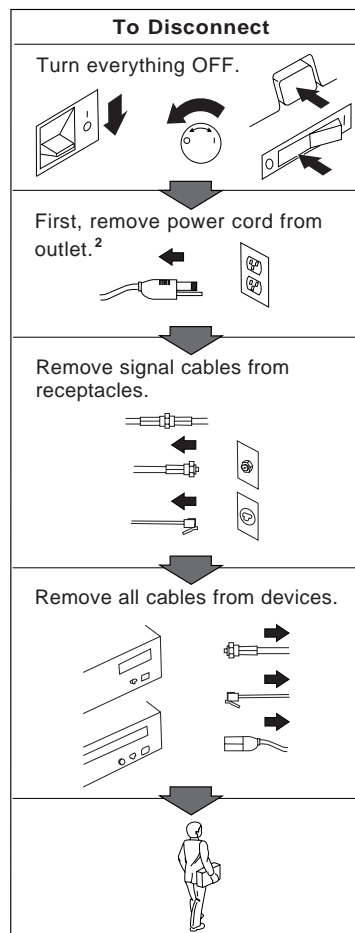

² In the U.K., by law, the power cord must be disconnected after the telephone line cable.

Laser Compliance Statement

Some IBM Personal Computer models are equipped from the factory with a CD-ROM drive. CD-ROM drives are also sold separately as options. The CD-ROM drive is a laser product. The CD-ROM drive is certified in the U.S. to conform to the requirements of the Department of Health and Human Services 21 Code of Federal Regulations (DHHS 21 CFR) Subchapter J for Class 1 laser products. Elsewhere, the drive is certified to conform to the requirements of the International Electrotechnical Commission (IEC) 825 and CENELEC EN 60 825 for Class 1 laser products.

When a CD-ROM drive is installed, note the following.

CAUTION:

Use of controls or adjustments or performance of procedures other than those specified herein might result in hazardous radiation exposure.

Opening the CD-ROM drive could result in exposure to hazardous laser radiation. There are no serviceable parts inside the CD-ROM drive. **Do not open.**

Some CD-ROM drives contain an embedded Class 3A or Class 3B laser diode. Note the following.

DANGER

<p>Laser radiation when open. Do not stare into the beam, do not view directly with optical instruments, and avoid direct exposure to the beam.</p>
--

Lithium Battery Notice

CAUTION:

Danger of explosion if battery is incorrectly replaced.

When replacing the battery, use only IBM Part Number 33F8354 or an equivalent type battery recommended by the manufacturer. The battery contains lithium and can explode if not properly used, handled, or disposed of.

Do not:

- **Throw or immerse into water**
- **Heat to more than 100°C (212°F)**
- **Repair or disassemble**

Dispose of the battery as required by local ordinances or regulations.

ATTENTION

Danger d'explosion en cas de remplacement incorrect de la batterie.

Remplacer uniquement par une batterie IBM de type 33F8354 ou d'un type équivalent recommandé par le fabricant. La batterie contient du lithium et peut exploser en cas de mauvaise utilisation, de mauvaise manipulation ou de mise au rebut inappropriée.

Ne pas :

- **Lancer ou plonger dans l'eau**
- **Chauffer à plus de 100°C (212°F)**
- **Réparer ou désassembler**

Mettre au rebut les batteries usagées conformément aux règlements locaux.

About This Book

This book will help you become familiar with your IBM Personal Computer and its many features. It describes how to configure, operate, and maintain your PC. In the unlikely event you experience problems, you will also find helpful troubleshooting information, as well as instructions for obtaining service.

The book is organized as follows:

- Chapter 1, "Your IBM Personal Computer," contains an overview of the features of your PC.
- Chapter 2, "Arranging Your Workspace," contains information about setting up your work area to optimize use of your computer. Safety considerations are also discussed.
- Chapter 3, "Operating Your Computer," contains instructions for the day-to-day use of your computer. Startup and shutdown procedures, as well as information on using audio, video, system-management, and security features are included in this chapter.
- Chapter 4, "Configuring Your Computer," contains instructions for using the Configuration/Setup Utility program.
- Chapter 5, "Taking Care of Your Computer," contains information about the proper handling and care of your PC.
- Chapter 6, "Solving Problems," contains information that will help you identify and correct problems that might arise as you use your computer.
- Chapter 7, "Getting Help, Service, and Information," contains a description of the wide variety of resources available from IBM to assist you in the use of your PC. This chapter also describes how to obtain additional information about IBM products.
- Appendix A, "Computer Records," contains forms for recording information about your PC, which can be helpful if you decide to install any additional options, or if you ever need to have your PC serviced.
- Appendix B, "Product Warranties, License Information, and Notices," contains warranty and license information for your computer, as well as legal notices and trademark information.

Related Publications

The following publications, together with this book, contain information about your computer.

- *Setting Up Your Personal Computer*
This publication contains instructions to help you set up your computer.
- *Installing Options in Your Personal Computer*
This publication contains instructions for adding memory, adapters, drives, and other options to your computer.
- *Understanding Your Personal Computer*
This online publication (provided only with computers that have IBM-preinstalled software) includes general information about using personal computers and in-depth information about the specific features of your PC. To purchase a printed copy of this publication, refer to “Ordering Publications” on page 106.
- *About Your Software*
This publication (provided only with computers that have IBM-preinstalled software) contains information about the preinstalled software package.
- *Adaptec SCSI Documentation*
This documentation, which is provided with computers that have an IBM-preinstalled SCSI adapter, includes information on configuring the adapter and instructions for installing and configuring SCSI devices.
- *Your Ready-to-Configure CD*
This publication contains information about the *Ready-to-Configure CD* that comes with your computer. The publication also contains instructions for starting the CD.

The following publications contain more information about your computer.

- *Hardware Maintenance Manual*
This separately purchased publication contains information for trained service technicians. To obtain a copy, refer to “Ordering Publications” on page 106.
- *Technical Information Manual*
This separately purchased publication contains information for individuals who want to know more about the technical aspects of their computer. To obtain a copy, refer to “Ordering Publications” on page 106.

Chapter 1. Your IBM Personal Computer

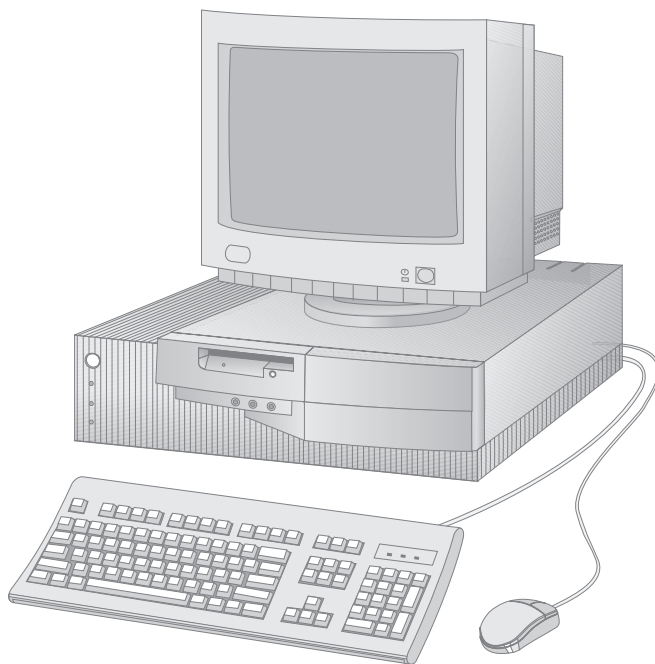

Thank you for selecting an IBM Personal Computer. Your PC incorporates many of the latest advances in personal computer technology and is easy to expand and upgrade as your needs change. With its enhanced audio, video, and system-management capabilities, your computer is particularly suited for your corporate intranet¹ environment.

¹ An intranet is a private network that conforms to the same protocols as the Internet, but is contained within an organization. The intranet contains one or more servers that provide services to the workstations on the private network. Some intranets are also connected to the Internet.

What Your IBM Personal Computer Offers

This section describes many of the features of your computer.

Microprocessor

At the core of your PC is an Intel® Pentium® processor or an Intel Pentium processor with MMX™ technology. With its advanced performance features, the microprocessor supplies the speed and power you need to take advantage of even the most complex programs. In addition, the microprocessor with MMX technology incorporates new multimedia extensions into the Intel architecture. MMX technology improves the performance of multimedia and communications applications by accelerating calculations commonly performed for audio, video, speech synthesis and recognition, 2D and 3D graphics, and data communications.

System Memory

Your computer comes standard with non-parity or ECC (error correcting code) EDO (extended data out) DRAM (dynamic random access memory). EDO uses advanced technology to increase system performance.

L2 Cache

L2 cache memory, which helps speed the exchange of information between the microprocessor and system memory, is integrated on the system board in your PC.

ISA Bus

Your PC has an ISA (industry standard architecture) bus, which is one of the most widely used and successful I/O (input/output) buses available. The ISA bus is popular because so many adapters and devices have been designed and marketed for it.

PCI Bus

Your computer also has a PCI (peripheral component interconnect) bus. PCI is one of the advanced I/O bus standards recently developed by the computer industry to keep up with performance improvements of microprocessor buses and advanced peripheral devices. The PCI bus adds to the capability of the ISA bus, speeding up the exchange of information among the microprocessor and peripheral devices within your computer system. This improves the overall performance of your computer, including the video and the hard disk drive.

Expansion with Adapters

By installing optional adapters, you can expand the capabilities of your computer and take advantage of a variety of peripheral devices and applications. Your computer has a riser card for connecting adapters to the ISA or PCI bus. Examples of adapters that can be added to your computer include graphics, SCSI (small computer system interface), and NIC (network interface controller) adapters.

High-Capacity Hard Disk Drives

Some PC models come with a hard disk drive that has an enhanced integrated drive electronics (EIDE) bus-master interface. The EIDE drive plugs into one of two EIDE connectors located on the riser card in your computer. You can connect an additional hard disk drive to the ribbon cable already attached to the riser card, or you can purchase another cable and connect up to two hard disk drives or other IDE or EIDE devices to the second connector on the riser card.

Notes:

1. A maximum of three internal IDE or EIDE devices can be installed—limited by the number of available bays.
2. For models with an IBM factory-installed CD-ROM, two ribbon cables (for connecting IDE or EIDE devices) are shipped with your computer.

Other PC models come with an ultra-wide SCSI hard disk drive that has a small computer system interface (SCSI) interface. These PC models have a PCI SCSI adapter installed in one of the expansion slots. If your computer has an IBM-preinstalled SCSI adapter, refer to the SCSI documentation provided with your computer for information on the adapter and for instructions on installing SCSI devices.

CD-ROM Drive

A CD-ROM drive is installed in some PC models. CD-ROM (compact disc read-only memory) technology offers quick access to enormous amounts of information. A compact disc can store more than 650 MB of data, such as the large files needed for audio, still and full-motion video, and still and animated graphics. A CD-ROM drive can play back or read from a CD, but it cannot write information on it.

ECP/EPP Parallel Port

Your PC has one 25-pin parallel port. The parallel port is most often used to communicate with a parallel printer, but it can also be used with other parallel devices.

The parallel port can operate in several different modes. The default mode for your computer is SPP (standard parallel port). However, your computer also supports the ECP/EPP (extended capabilities port/enhanced parallel port) mode. ECP/EPP has two advantages over SPP. When your computer is in ECP/EPP mode, you can print documents faster than when the computer is in SPP mode, and you can attach devices other than printers, such as communication and storage devices, to the parallel port. You can set modes of operation for the parallel port using the Configuration/Setup Utility program.

Serial Ports

Your computer has two standard 9-pin, 16550-UART serial ports that can be used to communicate with devices such as modems, plotters, and printers.

Universal Serial Bus Ports

The universal serial bus (USB) interface is a new, emerging technology being developed to add more diversity and capabilities to personal computers. IBM has provided two, 4-pin USB connectors in your computer as a standard feature so you can be ready to take advantage of new USB devices as they become available.

Using this new technology, you will be able to plug many different types of optional, USB-compatible devices into the USB port on your computer. Because USB incorporates Plug and Play technology, you can install and remove devices easily without turning off your computer or opening the cover. Once installed, the devices configure automatically.

In addition, an option called a *hub* can be connected to a USB port on your computer, which enables you to plug in more than one device at a time. A hub converts a single USB connector into multiple ports where USB devices can be attached. Note that your computer does not support a keyboard or mouse attached to the USB ports.

For more information, see the USB Web site (<http://www.usb.org>). For USB drivers, see the Microsoft Web site (<http://www.microsoft.com/support>).

Infrared Port (Optional)

Your computer supports infrared communication. With infrared technology, wireless communication is possible between infrared-enabled devices. In order for the infrared function to work, you must purchase and install a 115 Kb infrared module and a shielded cable/D-shell connector assembly. These components can be purchased from IBM or an IBM reseller as a single option package (referred to as the 4.0 Mbit IR Transceiver Option). The infrared module provides a link of up to 1 meter (3.3 feet) at a rate of 115 kilobits-per-second (Kbps). For further information on installing an infrared option package, refer to *Understanding Your Personal Computer* (an online publication) and the information that comes with the infrared package.

Integrated Video Graphics Controller

The system board of your computer contains a high-performance, high-resolution, Matrox MGA-1164SG² 3-D video graphics controller with 2 MB of video memory and support for Matrox memory and multimedia upgrade modules. (Note that you can install a maximum of one upgrade module, which means that the memory and multimedia upgrades cannot be used in conjunction with each other.) The system board of your PC also contains a VESA feature connector that supports special function video adapters, such as the ReelMagic TV tuner and MPEG decoder adapters.

Integrated Audio Controller

The stereo audio controller on the system board in your computer provides all the digital audio and analog mixing functions required for recording and playing high-quality sound on your PC. The controller supports Sound Blaster Pro, Adlib, and Microsoft Windows Sound System applications.

Integrated Ethernet Controller

Your computer has an integrated Intel 10/100 Mbit, PCI Ethernet controller and an RJ-45 connector that provide a high-performance network connection. The Ethernet controller is a Plug and Play device that has built-in support for Wake on LAN and a viewable MAC (media access control) address for your computer. (See “System-Management Settings” on page 52 for more information.) Ethernet device drivers are provided on the *Ready-to-Configure CD* that comes with your computer.

² Matrox changed the video controller markings from MGA-1064SG-H to MGA-1164SG-A. Although the markings are different, the video controller functions the same.

If your computer has IBM-preinstalled software, the device drivers are already installed on the hard disk. For instructions on connecting a network cable to your PC, refer to *Setting Up Your Personal Computer*.

System-Management Features

Your computer has features that make it possible for a network administrator to manage and control your computer remotely over a network from a management console. These features are:

- Enablement for LANClient Control Manager software
- RPL (Remote Program Load) and DHCP (Dynamic Host Configuration Protocol)
- Enablement for integrated Wake on LAN
- Automatic Power-On Startup Sequence
- Enablement for POST/BIOS updates over a network
- DMI (Desktop Management Interface) BIOS and DMI software
- Integrated system-management controller

For information on these features, refer to “Using System-Management Features” on page 25 and “System-Management Settings” on page 52.

IBM-Preinstalled Software

IBM-preinstalled software is provided with some PC models. This software includes an operating system, device drivers to support built-in features, and other support programs. Detailed information about this software is included in *About Your Software*, which is included with the preinstallation package.

Operating-System Support

Your computer is designed to use a variety of operating systems in order to meet your particular needs. See page 14 for a list of operating systems that you can use with your PC.

Ease-of-Use Features

Your computer has many features that make it easy to work with, including a state-of-the-art system board, Plug and Play technology, and easy-to-use diagnostic programs.

The IBM-designed system board in your computer makes upgrading and servicing your PC easier. Cable connections for standard devices are located on the riser card. This arrangement helps to eliminate cable tangle and clutter on the system board, allows shorter cables, and makes it easier to remove the system board or to

upgrade peripherals. In addition, the system board is on a sliding mechanism so that you can slide the system board in and out of the computer frame.

Support for Plug and Play technology is built into the system board of your PC. This feature makes adding options easier. When you add an adapter that is Plug and Play-compatible, the adapter is configured automatically. In most cases, no switches or jumpers have to be set on the adapter.

If you have a problem with your PC, IBM provides an easy-to-use diagnostic program (QAPLus/PRO) that you can run to help determine if a hardware component is causing the problem. A startable QAPLus/PRO diskette is provided with your computer. In addition, operating system-specific diagnostic programs (and QAPLus/PRO) are included on the *Ready-to-Configure CD* that comes with your computer. See page 95 for additional information.

Ergonomic Features

Your PC has ergonomic features that make it more comfortable to use. The power switch and indicator lights are located on the front panel for easy access and visibility. The microphone and headphone connections, along with a volume control for the headphone and internal speaker volume, are also located on the front panel for easy access and convenience. In addition, you can easily change monitor settings to reduce or eliminate flicker and jitter, and you can adjust the angle of the keyboard to make typing more comfortable.

Advanced Power Management

Energy conservation is an important concern. Your computer has Advanced Power Management (APM) features that allow you to set different levels of energy conservation for specific components of your computer. You can view and change APM settings using the Configuration/Setup Utility program or the Windows 95 control panel.

Asset Security Features

Your PC has the following security features that help protect both your hardware and software:

- Power-on and administrator password protection
- Startup-sequence control
- Hard disk drive and diskette drive access control
- I/O port control
- Enhanced security for administrator password and boot sequence
- Asset information protection
- Chassis-intrusion detector

- Enablement for updating the POST/BIOS over the network
- Cover lock
- U-bolt and security cabling (optional)
- Operating system security

Service and Support

You can obtain assistance for using your computer, as well as service, from a number of sources. Help is available on the World Wide Web and by phone, fax, and modem. For detailed information, see Chapter 7, “Getting Help, Service, and Information” on page 99.

Expandability

You can easily expand the capabilities of your computer by adding memory, drives, or adapters.

Drive Bays: Your computer has four drive bays. Unoccupied drive bays can be used for installing additional devices such as hard disk and CD-ROM drives.

The following illustration shows the drive bays in your computer.

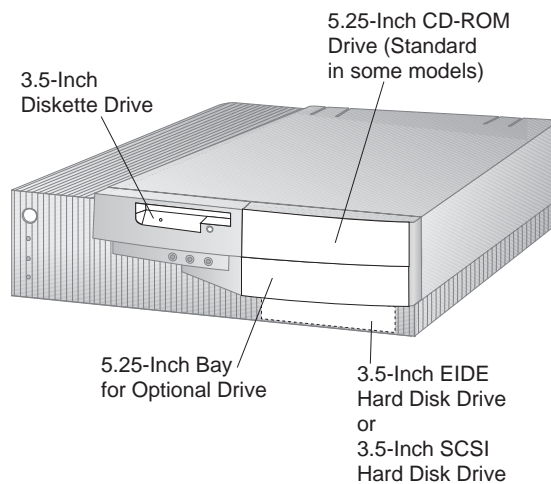

Expansion Slots: Your computer has four expansion slots. One or more of these slots might be occupied, depending on the model of your PC. Unoccupied slots can be used for installing adapters. The following illustration shows the locations of the expansion slots.

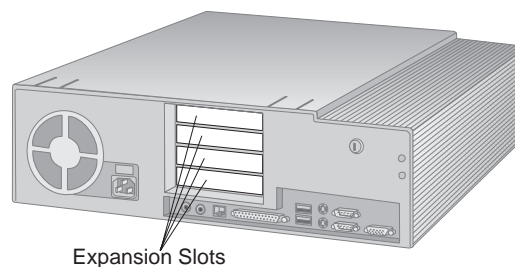

Connectivity

The following illustration shows the location of the external connectors on the rear of your computer. Note that some models have a SCSI adapter installed in one of the expansion slots. The SCSI adapter has an external connector.

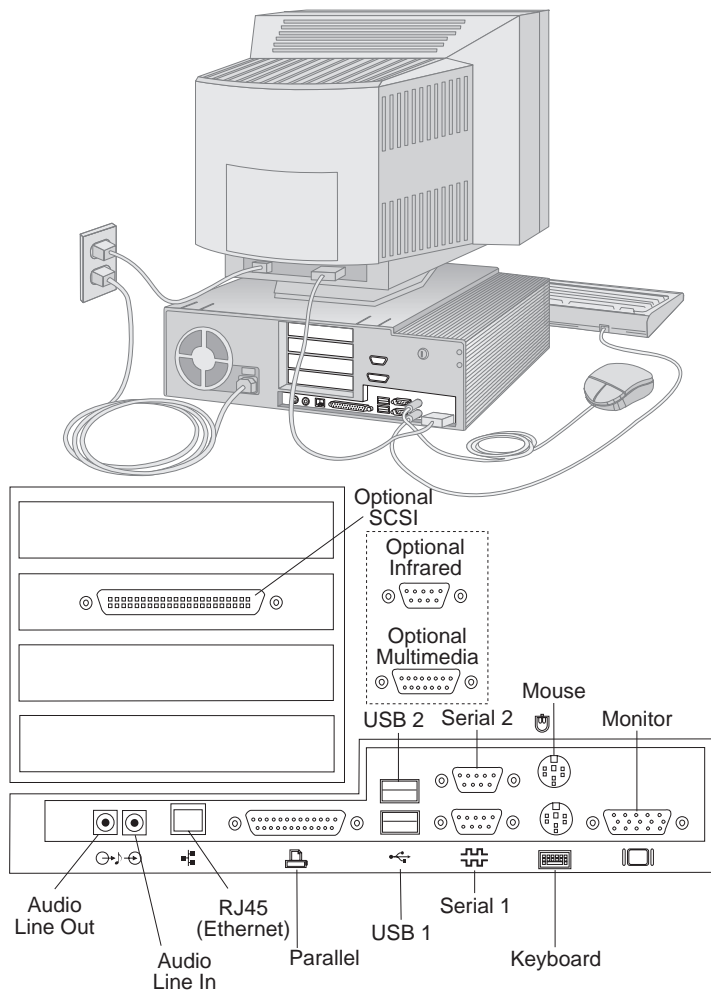

Features at a Glance

The following information covers a variety of PC models. Some of the features listed apply to specific models only. For a listing of features for your specific model, refer to the System Summary screen in the Configuration/Setup Utility program. For instructions on gaining access to the Configuration/Setup Utility program and the System Summary screen, refer to “Viewing the System Summary” on page 38.

Microprocessor

- Intel Pentium processor
or
- Intel Pentium processor with MMX technology

Memory

- Installed: 60 ns EDO (extended data out) DRAM, non-parity or ECC (error correcting code) DIMMs
- Maximum addressable: 384 MB (use only industry-standard, gold lead, 3.3 V, unbuffered, DRAM DIMMs)
- Three 168-pin DIMM sockets
- Flash memory for system programs

Level 2 Cache

- Integrated pipeline burst, synchronous level-2 (L2) cache
- Installed: 512 KB
- Maximum: 512 KB

Diskette Drives

- Installed: One 3.5-inch, 1.44 MB
- Maximum: One

Internal Hard Disk Drives

- Standard: One EIDE or one SCSI
- PCI EIDE bus-master or ultra-wide SCSI interface
- Maximum IDE or EIDE devices: Three total
- Maximum ultra-wide SCSI devices: Refer to the SCSI documentation that comes with your computer (if your computer has an IBM-preinstalled SCSI adapter)

CD-ROM Drive

- One IDE CD-ROM drive (standard in some models)

Input/Output Features

- One 25-pin, ECP/EPP parallel port
- Two 9-pin, serial ports
- Two 4-pin, USB ports
- Mouse port
- Keyboard port (Windows 95-compatible)
- One 15-pin, DDC2B-compliant monitor port
- Four 3.5 mm audio jacks (line out, line in, headphone, and microphone)
- One 8-pin, Ethernet RJ-45 port
- Infrared port (optional)
- Multimedia port (optional)

Video Controller

- Integrated Matrox MGA-1164SG 3-D video controller with 2 MB SGRAM³
 - Support for an additional 2 MB of SGRAM memory
 - Support for Matrox Rainbow Runner Studio multimedia upgrade⁴

Audio Controller

- Integrated audio controller that supports Sound Blaster Pro, Adlib, and Microsoft Windows Sound System applications

Ethernet Controller

- Integrated Intel 10/100 Mbit, PCI Ethernet controller

System Management

- Enablement for LANClient Control Manager software
- RPL (Remote Program Load) and DHCP (Dynamic Host Configuration Protocol)
- Enablement for integrated Wake on LAN Ethernet controller
- Automatic Power-On Startup Sequence

³ SGRAM is a type of RAM (random-access memory) that is used for storing data to be processed by the video controller.

⁴ The Matrox MGA-1164SG 3-D video controller can be upgraded with one upgrade module only. Therefore, the Rainbow Runner Studio multimedia upgrade and the 2 MB memory upgrade cannot be used in conjunction with each other.

- Enablement for POST/BIOS updates over a network
- DMI (Desktop Management Interface) BIOS and DMI software
- Integrated system-management controller

Expansion

- Four drive bays total—unoccupied bays can be used for installing additional internal devices, such as a second hard disk drive.
- Four expansion slots total (one ISA, two PCI, and one shared ISA/PCI)—unoccupied slots can be used for installing optional adapters.
- PCI/ISA Plug and Play adapter support.
- Support for optional SCSI devices (if your computer has an IBM-preinstalled SCSI adapter). Refer to the SCSI documentation provided with your computer for additional information.

Power

- 145 W, 115/230 V ac, 50/60 Hz
- Built-in overload and surge protection
- Advanced Power Management

Asset Security

- Power-on and administrator passwords
- Enhanced security for administrator password and boot sequence
- Startup sequence control
- Update POST/BIOS over network
- Startup without keyboard, diskette drive, or mouse
- Hard disk drive and diskette drive access control
- I/O port control to disable input and output functions of the serial and parallel ports and their attached devices
- Diskette write protection (prevents the diskette drive from writing to diskettes)
- Cover keylock
- Chassis-intrusion detector
- Software-readable hardware identification data
- System bolt-down support

Operating Systems (Supported)

- IBM OS/2 Warp Version 4.0
- Microsoft Windows 95
- Microsoft Windows NT Workstation Version 4.0

Operating Systems (Tested for Compatibility)⁵

- IBM OS/2 Warp Version 3.0 with DOS and Windows application support
- IBM OS/2 Warp Connect Version 3.0 with DOS and Windows application support
- IBM PC DOS Version 7.0
- MS DOS Version 6.22
- Microsoft Windows for Workgroups Version 3.11
- Microsoft Windows NT Version 3.51

IBM-Preinstalled Software

Preinstalled in some PC models are an operating system, device drivers to support built-in features, and other support programs. See *About Your Software* for a detailed description of the preinstallation package.

⁵ IBM has identified the operating systems listed here as the ones it has tested or intends to test for compatibility. It is possible, however, that IBM's testing may not be complete for some of these operating systems at the time this publication goes to press. Also, additional operating systems might be identified by IBM as compatible with your computer following the publication of this booklet. Corrections and additions to the list are available in IBM's online compatibility report, which can be found on the World Wide Web (<http://www.us.pc.ibm.com/cdt/>). For additional information, see Chapter 7, "Getting Help, Service, and Information" on page 99.

System Specifications

Size

- Depth: 450 mm (17.7 in.)
- Height: 128 mm (5.0 in.)
- Width: 450 mm (17.7 in.)

Weight

- Minimum configuration as shipped: 9.9 kg (22 lb)
- Maximum configuration: 11.3 kg (25 lb)

Environment

- Air temperature:
 - System on: 10° to 32°C (50° to 90°F)
 - System off: 10° to 43°C (50° to 110°F)
- Humidity:
 - System on: 8% to 80%
 - System off: 8% to 80%
- Maximum altitude: 2134 m (7000 ft)

Heat Output

- Approximate heat output in British thermal units (Btu) per hour:
 - Minimum configuration: 120 Btu (35 watts)
 - Maximum configuration: 700 Btu (204 watts)

Electrical Input

- Sine-wave input (50 to 60 Hz) is required
- Input voltage:
 - Low range:
 - Minimum: 90 V ac
 - Maximum: 137 V ac
 - Voltage switch setting: 115 or 115 V
 - High range:
 - Minimum: 180 V ac
 - Maximum: 265 V ac
 - Voltage switch setting: 230 or 230 V
 - Input kilovolt-amperes (kVA) (approximately):
 - Minimum configuration as shipped: 0.08 kVA
 - Maximum configuration: 0.52 kVA

Power consumption and heat output vary depending on the number and type of optional features installed and the power-management optional features in use.

Airflow

Approximately 0.56 cubic meters per minute (20 cubic feet per minute)

Acoustical Noise-Emission Values

- Average sound-pressure levels:
 - At operator position:
 - 36 dBA idle
 - 41 dBA operating
 - At bystander position-1 meter (3.3 ft):
 - 29 dBA idle
 - 35 dBA operating
- Declared (upper limit) sound power levels:
 - 4.8 bels idle
 - 5.1 bels operating

These levels were measured in controlled acoustical environments according to procedures specified by the American National Standards Institute (ANSI) S12.10 and ISO 7779, and are reported in accordance with ISO 9296.

Actual sound-pressure levels in your location might exceed the average values stated because of room reflections and other nearby noise sources. The declared sound power levels indicate an upper limit, below which a large number of computers will operate.

Chapter 2. Arranging Your Workspace

To get the most from your computer, arrange both the equipment you use and your work area to suit your needs and the kind of work you do. Your comfort is of foremost importance, but light sources, air circulation, and the location of electrical outlets also can affect the way you arrange your workspace.

Comfort

Although no single working position is ideal for everyone, here are a few guidelines to help you find a position that suits you best.

Sitting in the same position for a long time causes fatigue. A good chair can make a big difference. The backrest and seat should adjust independently and provide good support. The seat should have a curved front to relieve pressure on the thighs. Adjust the seat so that your thighs are parallel to the floor and your feet are either flat on the floor or on a footrest.

When using the keyboard, keep your forearms parallel to the floor and your wrists in a neutral, comfortable position. Try to keep a light touch on the keyboard and your hands and fingers relaxed. You can change the angle of the keyboard for maximum comfort by adjusting the position of the keyboard feet.

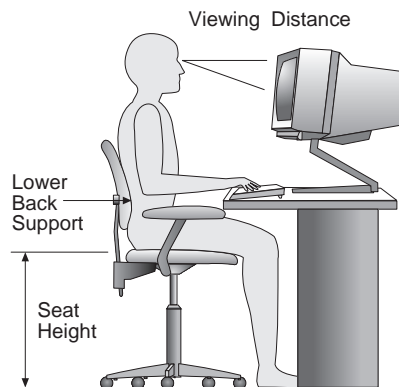

Adjust the monitor so the top of the screen is at, or slightly below, eye level. Place the monitor at a comfortable viewing distance, usually 51 to 61 cm (20 to 24 in.), and position it so you can view it without having to twist your body.

Glare and Lighting

Position the monitor to minimize glare and reflections from overhead lights, windows, and other light sources. Place the monitor at right angles to windows and other light sources, when possible. Reduce overhead lighting, if necessary, by turning off lights or using lower wattage bulbs. If you install the monitor near a window, use curtains or blinds to block the sunlight. You might have to adjust the Brightness and Contrast controls on the monitor as the room lighting changes throughout the day.

Where it is impossible to avoid reflections or to adjust the lighting, an antiglare filter placed over the screen might be helpful. However, these filters might affect the clarity of the image on the screen; try them only after you have exhausted other methods of reducing glare.

Dust buildup compounds problems associated with glare. Remember to clean your monitor screen periodically using a soft cloth moistened with a nonabrasive liquid glass cleaner.

Air Circulation

Your computer and monitor produce heat. The computer has a fan that pulls in fresh air and forces out hot air. The monitor lets hot air escape through vents. Blocking the air vents can cause overheating, which might result in a malfunction or damage. Place the computer and monitor so that nothing blocks the air vents; usually, 51 mm (2 in.) of air space is sufficient. Also, make sure the vented air is not blowing on someone else.

Electrical Outlets and Cable Lengths

The location of electrical outlets and the length of power cords and cables that connect to the monitor, printer, and other devices might determine the final placement of your computer.

When arranging your workspace:

- Avoid the use of extension cords. When possible, plug the computer power cord directly into an electrical outlet.
- Keep power cords and cables neatly routed away from walkways and other areas where they might get kicked accidentally.

For more information about power cords, see “Power Cord Notice” on page 123.

Chapter 3. Operating Your Personal Computer

This chapter provides information to help you in the day-to-day use of your computer. It includes instructions for starting and shutting down your PC, as well as information on using audio, video, system-management, and security features.

Using Controls and Status Indicators

The following operating controls and status indicators are located on the front of your computer (the three audio features on the front of your computer are described on page 24):

Power Switch: Press this switch to turn your computer on or off. Do not turn off your computer if the in-use light for the hard disk drive or diskette drive is on.

Power-On Light: This status indicator lights when you turn on your computer.

Hard-Disk Drive Light: When this light is on, it indicates that the hard disk drive heads are being positioned or that your computer is reading from or writing to the hard disk.

Client (Workstation) LAN Light: When this light is on, it indicates that your computer is transmitting or receiving a data block (*frame*) that matches your computer's network address (*media access control, MAC, address*) to or from another workstation or from a server. Data blocks sent from your computer to other adapters (*broadcast transmits*) will not activate this light.

Diskette-Drive Light: When this light is on, it indicates that the diskette drive heads are being positioned or that your computer is reading from or writing to a diskette.

Diskette Eject Button: Push this button to release a diskette from the drive.

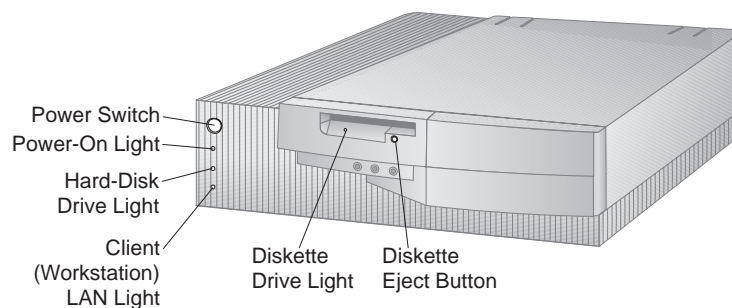

Starting Your Personal Computer

Note: If your computer is configured correctly, it can be started remotely over a network. For more information, see “Wake on LAN” on page 54.

1. Turn on all external devices, and then turn on your computer.

Numbers showing the amount of memory being tested appear in the top-left corner of the screen until the total amount of memory in the system is reached. Your computer is running the power-on self-test (POST). Options for running a fast POST or accessing the Configuration/Setup Utility program appear in the lower-left corner of the screen.

If POST finishes without detecting a problem, you hear one beep, and the first screen of your operating system or application program appears⁶ (if you have not set a power-on password). If you have set a power-on password, complete step 2.

2. If you have set a power-on password, a prompt appears on the screen. If you have set both power-on and administrator passwords, you can type either password at the password prompt. (Refer to “Passwords” on page 40 for instructions on setting and using passwords.) Type your password at the prompt and press **Enter**. The first screen of your operating system or application program appears.

Note: If POST detects a problem when you start your computer, you hear multiple beeps or no beep. In most cases, an error code appears in the top-left corner of the screen, and in some cases a description of the error is displayed beside the code. (Note that the screen will sometimes display multiple error codes and descriptions.) Write down all error code numbers and descriptions. For information on what caused an error message to appear and what action to take, refer to “Solving POST Error Message Problems” on page 64 and “POST Message Charts” on page 67.

If you hear no beep during POST, refer to “Troubleshooting Charts” on page 85. You might need to have your computer serviced.

⁶ IBM PCs with integrated Ethernet have special factory settings that affect the primary startup sequence. The computer tries to perform a remote program load (RPL) of the operating system. If RPL is unsuccessful, several messages might appear and then your computer loads the operating system from the hard disk drive. For information on the messages that might appear, see “Error Messages Specific to the Integrated Ethernet” on page 97.

Using a Mouse

A *mouse* is a device that you use to point to and select objects on the monitor screen. It connects to your computer by a cable. Some mouse devices are designed for the round mouse connector on the back of your PC; other mouse devices are designed for the D-shaped serial connector. You can use either type of mouse, if the correct software (device driver) is installed.

With a mouse, you can move the *pointer* on the monitor screen. If you have never used a mouse before, it might feel a bit awkward at first. However, with a little practice, the mouse movements will seem natural.

Place the mouse beside the keyboard on a flat surface or *mouse pad*. (A mouse pad is a flat, smooth, foam-rubber pad available at most computer stores.) The mouse has a ball on the bottom, so working on a flat, smooth surface is important. You can use your right or left hand to control the mouse.

Notice that the mouse has two buttons on the top (some mice have more buttons). Rest your hand comfortably on the mouse with your index finger on the left button (if you are using your right hand). Some programs and operating systems provide an option to set up the mouse for left-hand use. When a mouse is set up for left-hand use, the button functions are reversed.

Use the left button to select and open objects with the mouse. Some programs also use the right button. The use of the right mouse button varies.

To use the mouse, slide it from side to side and forward and backward on a flat surface. The pointer on the monitor screen moves as you move the mouse. When you see an item that you want to select on the screen, you simply move the pointer to that item (this is called *pointing*). Then you press and release the left button on the mouse (this is called *clicking*).

To learn how to use the mouse with the software in your computer, see the documentation accompanying the software.

Some programs support only one mouse button, others support two, and some support three. Despite the differences, some terms are fairly standard throughout the industry.

Point Move the mouse so the pointer is on the object you want.

Click Press and release the mouse button once.

Double-click Rapidly press and release the mouse button twice.

- Drag** Point to an object, press the mouse button, and hold it down as you move the mouse to relocate the object.
- Drop** After dragging an object to a new location, release the mouse button.

Shutting Down

When you are ready to turn off your computer, follow the shutdown procedure for your operating system to prevent the loss of unsaved data or damage to your software programs. See your operating-system documentation for instructions.

Using Video Features

Your computer has a Matrox MGA-1164SG 3-D SVGA (super video graphics array) controller. SVGA is a video standard for displaying text and graphic images on a monitor screen. Like other video standards, SVGA supports a variety of *video modes*. Video modes are different combinations of resolution, refresh rate, and color depth defined by a video standard for displaying text or graphics. (For further information on video modes, refer to *Understanding Your Personal Computer*.)

SVGA provides higher-resolution graphics, faster refresh rates, and more colors than previous video standards, such as video graphics array (VGA). At the same time, SVGA supports all standard VGA modes.

To get the best possible image on your screen and to reduce flicker, you might need to reset the resolution and refresh rate of your monitor. You can view and change monitor settings through your operating system. Instructions for doing this are included in a Matrox README file that is provided on the *Ready-to-Configure CD* that comes with your computer. (There are several Matrox README files on the CD; use the one that corresponds to your operating system.) When you open the appropriate README file, a prompt might appear requesting you to specify Mystique or Millennium. Specify Mystique.

Refer to your operating-system documentation for further information on monitor settings.

Attention

Before you change any monitor settings, be sure to review the information that comes with your monitor. Using a resolution or refresh rate that is not supported by your monitor might cause the screen to become unreadable and damage the monitor. The information that comes with your monitor usually includes the resolutions and refresh rates that the monitor supports. If you need additional information, contact the manufacturer of the monitor.

To minimize screen flicker and jitter, set your monitor for the highest noninterlaced refresh rate that the monitor supports. If your monitor complies with the VESA Display Data Channel (DDC) standard, it is probably already set to the highest refresh rate that the monitor and video controller can support. If you are not sure if your monitor is DDC-compliant, refer to the documentation provided with the monitor.

Video Device Drivers

To take full advantage of the Matrox MGA-1164SG 3-D video controller in your computer, some operating systems and application programs require custom software, known as video device drivers. These device drivers provide support for greater speed, higher resolution, more available colors, and flicker-free images.

The video device drivers are provided on the *Ready-to-Configure CD* that comes with your computer. Instructions for installing the device drivers are provided on the *Ready-to-Configure CD* in the Matrox README file that corresponds to your operating system. (When you open the README file, a prompt might appear requesting you to specify Mystique or Millennium. Specify Mystique.)

If your computer has IBM-preinstalled software, video device drivers have already been installed on the hard disk in your PC. However, the device driver installation instructions in the Matrox README file will be helpful if you ever need to reinstall the device drivers; if you want to change video resolution, color depth, or monitor settings; or if you need information on obtaining and installing updated device drivers.

Video Options

This section describes video options that are supported by your computer.

Matrox Upgrade Modules: Your computer supports Matrox memory and multimedia upgrade modules. Descriptions of the upgrades follow.

Note: Your computer supports a maximum of one Matrox upgrade module. This

means that a memory upgrade module cannot be used in conjunction with a multimedia upgrade module.

Memory Upgrade: Your computer has 2 MB of video memory (SGRAM) soldered to the system board. You can upgrade the video memory to 4 MB total with a Matrox memory upgrade module (daughter card).

Multimedia Upgrade: Your computer supports Matrox Rainbow Runner multimedia upgrade modules. These upgrades are available in several configurations:

- Rainbow Runner VIDEO, which includes features such as a hardware Moving Pictures Experts Group (MPEG) and Audio Video Interlace (AVI) decoder snap-on module; Video Out for displaying PC applications on your TV; Video In for capturing video from external devices; and accelerated DirectDraw video.
- Rainbow Runner TV, which is a cable-ready, Plug and Play, ISA adapter for PC-based multimedia applications. It enables you to watch TV in a window on your computer Desktop, and it supports 125 cable channels at full National Television Standards Committee (NTSC) frame rates. This option must be used in conjunction with the Rainbow Runner MPEG or Rainbow Runner VIDEO options. Features of Rainbow Runner TV include an ISA TV tuner board for viewing high quality TV on your PC, support for up to 125 channels, support for closed captioning, and easy programming of TV channels.

For information on ordering Matrox upgrade modules, contact your IBM reseller or IBM marketing representative.

Video Adapters: The computer system board has a VGA VESA feature connector that supports special function video adapters, such as the ReelMagic TV tuner and MPEG decoder adapters. For information on installing adapters, refer to *Installing Options in Your Personal Computer*.

Using Audio Features

Your computer has a stereo audio controller on the system board that enables you to record and play back high-quality sound on your PC.

Other audio features in your computer include a built-in, high-quality speaker and four audio jacks (or ports). The jacks are industry-standard, 3.5 mm mini-jacks. (The jacks are also referred to as 1/8" mini-jacks). A description of these jacks follows. For the location of the jacks, refer to the illustration included in this section and the illustration on page 10.

- **Audio Line Out:** Use this jack to send audio signals from the computer to external devices, such as stereo speakers with built-in amplifiers, multimedia keyboards, or the line-in receptacle of your stereo system.
- **Audio Line In:** Use this jack to send audio signals from an external device (such as a CD player or stereo) to your computer so that the signals can be recorded on the hard disk.
- **Headphone:** Use this jack to connect headphones or small bookshelf speakers to your computer. The speakers must have built-in amplifiers). If headphones are inserted in the jack, the computer built-in speaker is muted (except for system beeps).
- **Microphone:** Use this jack to connect a microphone to your PC so that you can record your voice or other sounds on the hard disk. This jack can also be used by speech recognition software.

Your computer also has a volume control dial that adjusts the sound level for the headphone jack and built-in speaker.

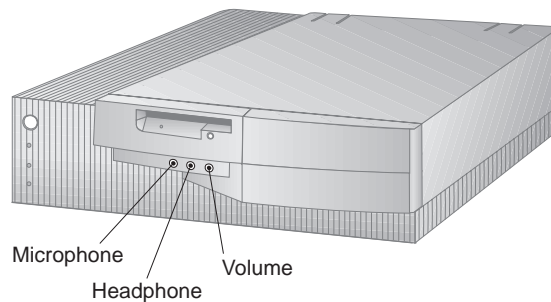

Procedures for recording and playing back sound vary by operating system. Refer to your operating-system documentation for information and instructions.

Using System-Management Features

This section is intended primarily for network administrators. It describes features of your computer that make it possible for a network administrator to remotely manage and control your PC when it is linked to a network.

The BIOS (basic input output system) of your computer supports an interface called DMI (Desktop Management Interface). DMI is software used to gather information about the hardware and software in your computer so that network administrators

can remotely monitor and control your PC. DMI can be used to remotely track many types of information about networked PCs, including serial numbers, memory attributes, product-specific characteristics of installed peripherals, and operating system configuration information. This information can be accessed using a DMI browser. DMI browsers are provided by all major operating systems and all major LAN management packages (including TME 10 NetFinity, Intel LAN Desk, and Microsoft SMS).

Your computer also has system-management hardware and software that provides power, temperature, fan speed, and chassis intrusion information that is accessible from a DMI browser.

The Wake on LAN feature can be used by a network administrator to turn on your PC from a management console. When Wake on LAN is used in conjunction with network-management software, such as TME 10 NetFinity Version 4 (provided on the *Ready-to-Configure CD* that comes with your computer), many types of functions, such as data transfers, software updates, and POST and BIOS updates can be performed remotely on your PC and other computers enabled for Wake on LAN that are linked to your network. This updating can be done after hours and on weekends, which saves time and increases productivity. Users are not interrupted during normal working hours and LAN traffic is kept to a minimum. Refer to “Wake on LAN” on page 54 for further information.

Other features such as remote program load (RPL) and dynamic host configuration protocol (DHCP) also allow a network administrator to remotely control your computer. If you use remote program load in conjunction with LANClient Control Manager software, you can use a feature called *Hybrid RPL*. Using LANClient Control Manager, you set up your computer by installing hybrid images (or files) on the hard disk drive. Then, each time the computer starts from the network, LANClient Control Manager recognizes your computer as a Hybrid RPL client and a *bootstrap* program is downloaded to your computer. This bootstrap program is small and helps prevent network congestion. Working off the hybrid images, the bootstrap program initiates the startup process from the hard disk drive of your computer. An advantage to Hybrid RPL is that the network load associated with standard RPL is avoided. Refer to “RPL and DHCP” on page 53 for further information.

System Programs

System programs are the basic layer of software built into every IBM PC. They include the power-on self test (POST), the basic input/output system (BIOS) code, and the Configuration/Setup Utility program. POST is a set of tests and procedures that is performed every time you turn on your PC. The BIOS is a layer of software

that translates instructions from other layers of software into instructions that the computer hardware can understand. The Configuration/Setup Utility program enables you to view and change the configuration and setup of your computer.

In the past, the system programs were contained in a read-only memory (ROM) module on the system board. If you wanted to update POST routines, BIOS instructions, and the Configuration/Setup Utility program, you had to disassemble the computer and replace modules, or you had to replace the system board. Now, the system programs are stored in an *EEPROM (electrically erasable programmable read-only memory)* module, which is also referred to as a *flash memory*. The contents of an EEPROM module can be easily updated with an update (flash) diskette. The process of updating the system programs EEPROM is often referred to as *flashing the BIOS*.

As part of the continuing work to improve quality, IBM might make changes and enhancements to the system programs. When updates are released, they will be available on the World Wide Web (<http://www.pc.ibm.com/cdt/>) or through the PC Company Bulletin Board Service (see “Using Electronic Support Services” on page 100) in files that can be downloaded onto a diskette. Updates on the Web site or BBS will have the file name NFJTnnA.EXE, where *nn* is a release number. Instructions for using the system programs updates will be available in a README file included in the downloaded files. When updating system programs with a flash diskette, note the following:

- If you have set an administrator password, your computer will halt and request the administrator password. The update process will not begin until you enter the password.
- If you have set an administrator password and enhanced security is enabled, the system programs update will run only if you first perform a cold startup (the computer is turned off and then turned on).

If your computer is connected to a network, the system programs also can be updated remotely, using network-management software, such as IBM LANClient Control Manager. For further information on this procedure, refer to “Update POST/BIOS from Network” on page 55.

Using a CD-ROM Drive

Some PC models have a preinstalled 16X Max CD-ROM drive. CD-ROM (compact disc read-only memory) technology offers quick access to enormous amounts of information. A compact disc can store more than 650 MB of data, such as the large files needed for audio, still and full-motion video, and still and animated graphics. A CD-ROM drive can play back or read from a CD, but it cannot write information to it. CD-ROM drives use industry-standard, 12 cm (4.75-inch) CDs.

Follow these guidelines when using a CD-ROM drive:

- Do not place the drive where there is:
 - High temperature
 - High humidity
 - Excessive dust
 - Excessive vibration or sudden shock
 - An inclined surface
 - Direct sunlight
- Do not insert any object other than a CD into the drive.
- Before moving the computer, remove the CD from the drive.

The following is an illustration of the front bezel of the CD-ROM drive preinstalled in some PC models.

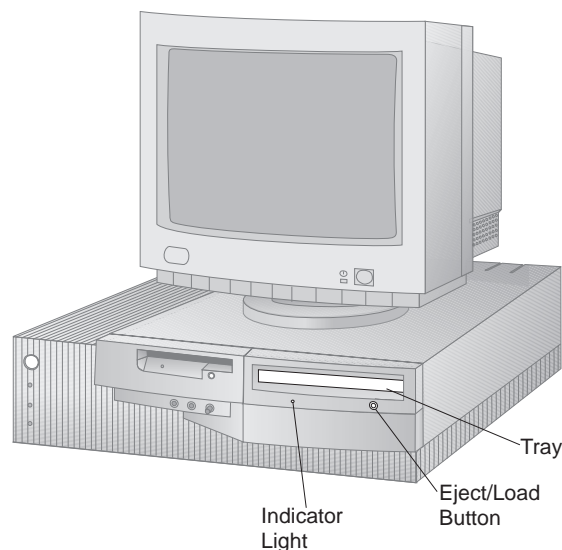

Handling a CD

When handling a CD, follow these guidelines:

- Hold the CD by its edges. Do not touch the surface.
- To remove dust or fingerprints, wipe the CD from the center to the outside. Wiping the CD in a circular direction might cause loss of data.
- Do not write or stick paper on the CD.
- Do not scratch or mark the CD.
- Do not place or store the CD in direct sunlight.
- Do not use benzene, thinners, or other cleaners to clean the CD.
- Do not drop or bend the CD.

Loading a CD

To load a CD into the CD-ROM drive:

1. Press the Eject/Load button. The tray slides out of the drive. (Do not manually force the tray open.)

2. Place the CD in the tray with the label facing up. If you have placed your computer in a vertical position using an optional floor stand,⁷ extend the four clips on the tray so that the CD does not slip off the tray when the CD-ROM drive is operating.

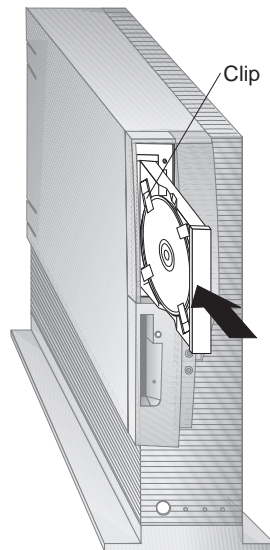

3. Close the tray by pressing the Eject/Load button, or by gently pushing the tray forward. When the tray is closed, the indicator light on the front of the drive will activate to indicate that the drive is in use.
4. To eject the CD, press the Eject/Load button. When the tray slides out, carefully remove the CD. (If the clips on the tray are extended, retract the clips before removing the CD.)
5. Close the tray by pressing the Eject/Load button, or by gently pushing the tray forward.

Note: If the tray does not slide out of the drive when you press the Eject/Load button, insert the pointed end of a large paper clip into the emergency-eject hole located above and to the left of (or near) the CD-ROM indicator light.

⁷ If you place the computer in a vertical position, use a floor stand to prevent damage to the computer due to overheating. Refer to *Installing Options in Your Personal Computer* for information on purchasing and installing a floor stand.

If you have installed a CD-ROM drive yourself and need additional information about the drive, refer to the documentation that comes with the CD-ROM drive.

Using Security Features

A variety of computer security features are provided to help protect your computer hardware and software. For additional information, see “Asset Security Features” on page 7.

Chapter 4. Configuring Your Computer

This chapter includes information on configuring your computer and includes instructions for using the Configuration/Setup Utility program.

Using the Configuration/Setup Utility Program

You can use the Configuration/Setup Utility program to view and change the configuration and setup of your computer, regardless of which operating system you are using. The Configuration/Setup Utility program is stored in the EEPROM (electrically erasable programmable read-only memory) of your PC.

Note: The settings you select in your operating system might override any similar settings in the Configuration/Setup Utility program.

The following is a brief description of the categories that appear in the main menu of the Configuration/Setup Utility program.

- **System Summary** provides information about the current options and features in your computer. Included in the system summary is information about the microprocessor, memory, video controller, and diskette and hard disk drives.
- **Product Data** contains information about the machine type and model, flash EEPROM revision level, system-board identifier, system serial number, and BIOS date.
- **Devices and I/O Ports** allows you to view and change hard disk drive, diskette drive, mouse, serial port, parallel port, video, audio, and Ethernet settings.
- **Start Options** allows you to view and change the device startup sequence, power-on options, and keyboard settings. It also allows you to enable or disable disketteless operation and virus detection.
- **Date and Time** allows you to view and change the date and time of the internal clock in your computer.
- **System Security** allows you to set power-on and administrator passwords. It also allows you to enable or disable the Update POST/BIOS from Network feature and to control access to the hard disk and diskette drives.
- **Advanced Setup** allows you to view and change settings for advanced hardware features, including ROM shadowing, cache control, PCI control, and Plug and Play control. The settings in Advanced Setup must be configured correctly. If they are not, your computer might malfunction.
- **ISA Legacy Resources** allows you to indicate which system resources (memory, I/O port, DMA, and interrupt) are used by ISA legacy adapters. For

information about required interrupt resource settings for ISA legacy adapters, refer to the documentation that comes with these adapters.

- **Advanced Power Management** allows you to view and change settings that affect the energy-saving features of your computer, including the automatic power-on feature.

Important

In most cases, when you add or remove hardware from your computer, the BIOS (basic input/output system) detects the changes and then updates the configuration automatically. Although the computer changes the configuration settings automatically, you must *save* these changes in the Configuration/Setup Utility program for the new configuration to take effect. If you do not save the new settings, your operating system will not start. To save the configuration after adding or removing hardware, complete the following steps.

1. When you turn on the computer, an error message indicating that a configuration change has occurred appears approximately 30 seconds after the memory-count numbers stop cycling in the top-left corner of the screen. When the configuration error message disappears, the POST Startup Errors screen appears, and you are prompted to **Continue** or **Exit Setup**. Select **Continue**. (If you select **Exit Setup**, you will get another error message.)
2. The Configuration/Setup Utility program menu appears with a right arrowhead (▶) next to the menu category in which the configuration change has occurred. Select this menu item if you want to view the new configuration settings, and then press **Esc** to return to the Configuration/Setup Utility program menu.
3. Select **Save Settings** from the Configuration/Setup Utility program menu.
4. Press **Esc** to exit the Configuration/Setup Utility program, and follow the instructions on the screen.

Starting the Configuration/Setup Utility Program

To start the Configuration/Setup Utility program:

1. Turn on your computer. If your PC is already on when you start this procedure, you must shut down the operating system, turn off the computer, wait a few seconds until all in-use lights go off, and restart the computer. (Do not use **Ctrl+Alt+Del** to restart the computer.)
2. When the Configuration/Setup Utility prompt appears in the lower-left corner of the screen during startup, press **F1**. (The Configuration/Setup Utility

program prompt appears on the screen for only a few seconds. You must press **F1** quickly.)

3. If you have *not* set an administrator password, the Configuration/Setup Utility program menu appears on the screen. If you have set an administrator password, the Configuration/Setup Utility program menu will not appear until you type your administrator password at the password prompt and press **Enter**.

If you have set both an administrator and a power-on password, you can type either of the passwords at the password prompt. However, if you think you might need to change any settings in the Configuration/Setup Utility program, type your administrator password at the password prompt. If you type your power-on password, you will be able to *view* limited information in the Configuration/Setup Utility program, but you will not be able to *change* any settings.

The menu you see on your computer might look slightly different from the menu shown here, but it will operate the same way.

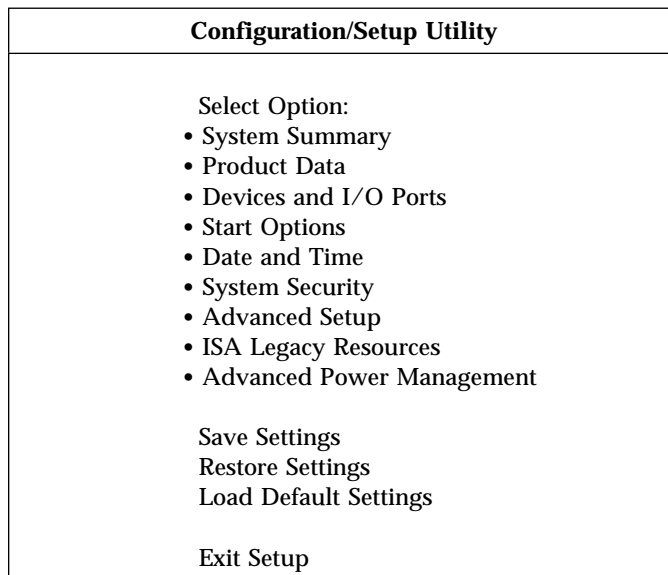

Viewing and Changing Settings in the Configuration/Setup Utility Program

The Configuration/Setup Utility program menu lists items that identify system configuration topics. If a bullet (•) appears beside a menu item, an additional menu is available. If a right arrowhead (▶) appears beside a menu item, a change to that item has been made or the Configuration/Setup Utility program detected an error and attempted to correct it. Also, an additional menu might follow a menu item with a ▶ beside it. An asterisk (*) next to a menu item indicates a system resource conflict. Resolve this conflict before exiting from the Configuration/Setup Utility program so that your computer will function properly. For information and instructions on resolving system resource conflicts, refer to *Installing Options in Your Personal Computer* and the documentation that comes with the hardware you want to install.

When working with the Configuration/Setup Utility program menu, you must use the keyboard. Refer to the following table for the keys used to accomplish various tasks.

Keys	Function
↑ ↓	Use these arrow keys to move between menu items until the item you want is highlighted.
← →	Use these arrow keys to display and toggle between choices for a menu item.
Enter	Press this key to select a highlighted menu item.
Esc	Press this key to exit from a menu after viewing or making changes to the settings in the menu.
+	Use this key in some menus to increase the numerical value of a setting.
-	Use this key (the minus or hyphen key) in some menus to decrease the numerical value of a setting.
0-9	Use these number keys in some menus to change the numerical value of a setting.
F1	Press this key for help on a selected menu item.
F9	Press this key if you changed and saved the setting of a selected menu item and you want to restore the setting that was active before you made the change.
F10	Press this key to return the setting of a selected menu item to a default value.

Note: Active keys are displayed at the bottom of each screen; not all of the above keys are active with every menu.

In the Configuration/Setup Utility program menus, the configuration information you can change is enclosed in brackets like these []. You cannot change information that is not surrounded by brackets.

Exiting from the Configuration/Setup Utility Program

When you finish viewing or changing settings in the Configuration/Setup Utility program, follow these steps to save any changes you have made and to exit from the program:

1. Press **Esc** until you return to the Configuration/Setup Utility program menu. (Depending on where you are in the program, you might have to press **Esc** several times to get back to the Configuration/Setup Utility program menu.)
2. Do one of the following:
 - a. To restore the settings that were in effect before you made changes and saved your changes, select **Restore Settings**.
 - b. To load the default values for all settings, select **Load Default Settings**.
 - c. To save any changed settings (including restored settings or default settings), select **Save Settings**. If you do not save settings here, you are given the opportunity to do so in the Exit Setup menu.
3. From the Configuration/Setup Utility program menu, press **Esc**, and follow the instructions on the screen.

Viewing the System Summary

You can use the Configuration/Setup Utility program to view a summary of the options and features in your computer. To view the system summary:

1. Start the Configuration/Setup Utility program (see “Starting the Configuration/Setup Utility Program” on page 34).
2. Select **System Summary** from the Configuration/Setup Utility program menu. The System Summary screen appears.

Depending on your PC model and configuration, your screen might appear slightly different from the one shown here.

System Summary	
Processor	Pentium
Processor Speed	166 MHz ⁸
Math Coprocessor	Internal
System Memory	640 KB
Extended Memory	31 MB
Video Controller	Matrox Graphics Inc.
Cache Size	512 KB
Cache State	Enabled
Shadow RAM	384 KB
System ROM	F000h - FFFFh
Memory Type	Non-parity
Diskette Drive A:	1.44 MB, 3.5"
Diskette Drive B:	Not Installed
Hard Disk Drive 0	2560 MB
Hard Disk Drive 1	Not Installed
CD-ROM Drive 2	Installed
Hard Disk Drive 3	Not Installed
Mouse	Installed

⁸ MHz denotes internal clock speed of the microprocessor only; other factors might also affect application performance.

Setting the Date and Time

Your computer has an internal clock that maintains the date and time. A battery keeps the clock active when you turn off the computer.

To set the date and time:

1. Start the Configuration/Setup Utility program (see “Starting the Configuration/Setup Utility Program” on page 34).
2. Select **Date and Time** from the Configuration/Setup Utility program menu.
3. Type the date and time in the appropriate fields.
4. Refer to “Exiting from the Configuration/Setup Utility Program” on page 37 for instructions on saving your settings and exiting from the Configuration/Setup Utility program.

Your operating system might also have a function for setting the date and time. Refer to your operating system documentation for more information.

Changing Plug and Play Control Features

If you are installing a Plug and Play adapter or other device and experience problems, you might need to change certain settings in Plug and Play Control in the Configuration/Setup Utility program.

Note: If you experience any error message related to Plug and Play adapters or devices, see “POST Message Charts” on page 67 for complete information on solving the problem.

A setting that might affect the way a Plug and Play adapter behaves is the Address Decode setting. Most Plug and Play adapters use 16-bit address decoding (this is the default setting for Address Decode.). Some Plug and Play adapters have not fully implemented this addressing scheme. If you are experiencing problems with a Plug and Play adapter, changing the address decoding to **10-bit** might fix the problem. Conversely, if you are experiencing an 1852 error message, changing the address decode setting to **16-bit** might fix the problem.

Another setting that affects any type of Plug and Play device is the Plug and Play Operating System setting. If you install a Plug and Play adapter or device and experience a 185x error message, and your computer will be loading a Plug and Play-compliant operating system, set this value to **Yes**.

Note: Check your operating system documentation to determine if it supports this function.

The 185x error messages occur because the computer is unable to configure all adapters and devices in the system due to conflicting resource assignments. Selecting **Yes** allows the configuration of Plug and Play devices to be performed by the operating system.

To change Plug and Play control settings, select **Advanced Setup** and then **Plug and Play Control**. The next menu displays **Address Decode** and **Plug and Play Operating System**.

Passwords

Two types of password protection are available to help you secure your computer and the information you store in it. The *power-on* password feature deters unauthorized persons from gaining access to the information stored in your computer. The *administrator password* feature helps prevent unauthorized persons from accessing the Configuration/Setup Utility program and changing the setup of your computer. You can set a power-on password, an administrator password, or both.

Other password security features might be available through your operating system or network.

Power-On Password

You do not need a power-on password to use your PC, but setting this type of password deters unauthorized persons from using your computer. When a power-on password is set, you must type the password at the password prompt that appears as the computer starts.

When you set the power-on password, you can choose one of three password prompt modes:

- On** In password prompt On mode, you are prompted for the power-on password when you turn on the computer. Until the correct password is entered, the operating system will not start, and the keyboard will remain locked. If you have a mouse connected to the mouse port, it also will remain locked. If you have a mouse connected to a serial port, it will be activated when the computer is started, regardless of whether a password is set.
- Off** In password prompt Off mode (also referred to as Unattended Start mode), you are not prompted to enter your power-on password when you turn on the computer. The computer will start the operating system.

(However, if you have a mouse connected to the mouse port, refer to the **Important Information for Mouse Users** text box on page 42.)

When the operating system starts in password prompt Off mode, the keyboard remains locked. If you have a mouse connected to the mouse port, it also remains locked.

Although you are not prompted to type a password in this mode, you can type your power-on password anytime after POST has completed, even after the operating system has loaded. If you type a password, the keyboard will unlock, but the mouse connected to the mouse port will remain disabled.

Password prompt Off mode is useful for network servers and other computers that operate unattended. If a power failure occurs, the computer will automatically restart and resume operating when power is restored, without operator intervention.

Important Information for Mouse Users

This information applies only to those who have a mouse connected to the mouse port; a serial mouse is not affected by the password prompt Off mode.

The password prompt Off mode prevents the computer from detecting that a mouse is attached. Because the mouse device driver will not be loaded automatically through the CONFIG.SYS or AUTOEXEC.BAT files in this mode, an error message that the mouse port is disabled will appear and the computer will halt. To enable the operating system to load without displaying the error message, read the information below that applies to your operating system.

If you are using OS/2, do one of the following before enabling password prompt Off mode:

- Set the CONFIG.SYS file so the operating system does not stop on a device-driver error. To do this, put the command PAUSEONERROR=NO near the top of the CONFIG.SYS file.

or

- Remove the mouse driver statement from the CONFIG.SYS file.

If you are using Windows 95, do the following:

- When the computer is started and the mouse port disabled error message appears, enter either your power-on or administrator password to enable the keyboard. Then use the keyboard to put a check mark in the "Do not display this message in the future" check box.

Dual In the password prompt Dual mode, the startup behavior of the computer depends on whether the computer is started by pressing the power switch or by an unattended method, such as Wake on LAN.

If you start the computer by using the power switch, the computer operates the same as it does in password prompt On mode. Refer to page 40 for further information.

If the computer is started by an unattended method, such as remotely over a LAN, the computer operates the same as it does in password prompt Off mode. Refer to page 40 for further information.

Note: Even though the mouse and keyboard are not active, the system can still be managed remotely by network-management software, such as NetFinity or Intel LAN Desk. These programs provide a network-based secure connection to the clients.

If both a power-on and administrator password are set, you can type either password at the password prompt *that appears as you start your computer*. However, if you want to change any settings in the Configuration/Setup Utility program, you must type your administrator password at the password prompt *that appears when you try to access the Configuration/Setup Utility program*. If you type your power-on password at this prompt, you will be able to view limited information in the Configuration/Setup Utility program, but you will not be able to change any settings.

The password does not appear on the screen as you type it. If you type the wrong password, you receive a screen message telling you so. If you type the wrong password three times, you must turn off the computer and start again. When you type the correct password, the keyboard and mouse will unlock, and the computer will begin normal operation.

Setting and Changing a Power-On Password: Use the Configuration/Setup Utility program to set or change a power-on password. You can use any combination of up to seven characters (A–Z, a–z, and 0–9) for this password.

Attention: Keep a record of your power-on password in a secure place. When a power-on password has been set, you cannot activate the keyboard and mouse without first using the password. If you lose or forget your password, you cannot change or delete it without removing the computer cover and moving a jumper on the system board. Refer to “Erasing a Lost or Forgotten Power-On Password” on page 44 for further information.

To set or change a power-on password:

1. Start the Configuration/Setup Utility program (see “Starting the Configuration/Setup Utility Program” on page 34).
2. Select **System Security** from the Configuration/Setup Utility program menu.
3. Select **Power-On Password**.
4. Type your password and press Down Arrow (↓).
5. Type your password again.
6. At **Password Prompt**, select **On**, **Off**, or **Dual**. Press Left Arrow (←) or Right Arrow (→) to toggle between selections.
7. Select **Set or Change Power-On Password**, and follow the instructions on the screen.
8. Refer to “Exiting from the Configuration/Setup Utility Program” on page 37 for instructions on saving your settings and exiting from the Configuration/Setup Utility program.

Deleting a Power-On Password: Use the Configuration/Setup Utility program to delete a power-on password.

To delete a power-on password:

1. Start the Configuration/Setup Utility program (see “Starting the Configuration/Setup Utility Program” on page 34).
2. Select **System Security** from the Configuration/Setup Utility program menu.
3. Select **Power-On Password**.
4. Select **Delete Power-On Password** and follow the instructions on the screen.
5. Refer to “Exiting from the Configuration/Setup Utility Program” on page 37 for instructions on saving your settings and exiting from the Configuration/Setup Utility program.

Erasing a Lost or Forgotten Power-On Password: If you have lost or forgotten your power-on password, you must remove the computer cover and move the CMOS Clear jumper (also referred to as the *password* jumper on the system board) in order to erase the power-on password so that you can regain access to your system.

See *Installing Options in Your Personal Computer* for instructions on removing the computer cover and moving jumpers. Refer to the system board label inside the computer cover for the location of the CMOS Clear (password) jumper.

Important

If you move the CMOS-clear jumper, the Configuration/Setup Utility program will load the default settings. If you do not want to use the default settings, use the Configuration/Setup Utility program to reconfigure the computer and to set a new password.

Administrator Password

Setting an administrator password deters unauthorized persons from changing settings in the Configuration/Setup Utility program. When an administrator password is set, you can change settings in the Configuration/Setup Utility program only after typing the administrator password at the password prompt that appears when you try to access the Configuration/Setup Utility program.

If you are responsible for maintaining the settings of several computers, you might want to set an administrator password.

When you set an administrator password, a password prompt appears each time you try to access the Configuration/Setup Utility program. The password does not appear on the screen as you type it. If you type the wrong password, you receive a screen message telling you so. If you type the wrong password three times, you must turn off the computer and start again. When you type the correct password, the Configuration/Setup Utility program menu appears.

If both a power-on and administrator password are set, you can type either of the passwords at the password prompt *that appears as you start your computer*. However, if you want to change any settings in the Configuration/Setup Utility program, you must type your administrator password at the password prompt *that appears when you try to access the Configuration/Setup Utility program*. If you type your power-on password at this prompt, you will be able to view limited information in the Configuration/Setup Utility program, but you will not be able to change any settings.

Setting and Changing an Administrator Password: Use the Configuration/Setup Utility program to set or change an administrator password. You can use any combination of up to seven characters (A-Z, a-z, and 0-9) for the password.

Important

Keep a record of your administrator password in a secure place. If you lose or forget the administrator password, you will not be able to access the Configuration/Setup Utility program, and you will not be able to erase and reset an administrator password. If you lose or forget your password, you must complete *one* of the following steps in order to regain access to the Configuration/Setup Utility program:

1. If enhanced security is disabled (default setting), you must remove the computer cover and move a jumper on the system board. (Refer to “Erasing a Lost or Forgotten Administrator Password” on page 46 for further information.)
2. If enhanced security is enabled, you must replace the system board in your computer.

To set or change an administrator password:

1. Start the Configuration/Setup Utility program (see “Starting the Configuration/Setup Utility Program” on page 34).
2. Select **System Security** from the Configuration/Setup Utility program menu.
3. Select **Administrator Password**.

4. Type your password and press Down Arrow (↓).
5. Type your password again.
6. At **Power-On Password Changeable by User**, select **Yes** or **No**. Press Left Arrow (←) or Right Arrow (→) to toggle between selections. (If you select **Yes** and an administrator password is set, the power-on password can be changed without having to enter the administrator password. If you select **No** and an administrator password is set, the power-on password cannot be changed unless the administrator password is entered.)
7. Select **Set or Change Administrator Password** and follow the instructions on the screen.
8. Refer to “Exiting from the Configuration/Setup Utility Program” on page 37 for instructions on saving your settings and exiting from the Configuration/Setup Utility program.

Deleting an Administrator Password: Use the Configuration/Setup Utility program to delete an administrator password.

To delete an administrator password:

1. Start the Configuration/Setup Utility program (see “Starting the Configuration/Setup Utility Program” on page 34).
2. Select **System Security** from the Configuration/Setup Utility program menu.
3. Select **Administrator Password**.
4. Select **Delete Administrator Password** and follow the instructions on the screen.
5. Refer to “Exiting from the Configuration/Setup Utility Program” on page 37 for instructions on saving your settings and exiting from the Configuration/Setup Utility program.

Erasing a Lost or Forgotten Administrator Password: This section applies to lost or forgotten administrator passwords that are *not* protected by enhanced security. For information on lost or forgotten passwords that *are* protected by enhanced security, refer to “Erasing a Lost or Forgotten Administrator Password Protected by Enhanced Security” on page 49.

If you have lost or forgotten your administrator password and enhanced security is disabled, you must remove the computer cover and move the CMOS Clear jumper (also referred to as the *password* jumper) on the system board in order to erase the password so that you can regain access to the Configuration/Setup Utility program.

See *Installing Options in Your Personal Computer* for instructions on removing the computer cover and moving jumpers. Refer to the system board label inside the computer cover for the location of the CMOS Clear (password) jumper.

Important

If you move the CMOS-clear jumper, the Configuration/Setup Utility program will load the default settings. If you do not want to use the default settings, use the Configuration/Setup Utility program to reconfigure the computer and to set a new password.

Enhanced Security

By default, your administrator password is stored in CMOS memory. CMOS memory is battery-powered memory that stores your configuration, setup, and security settings. The information stored in CMOS remains there for the life of the battery, as long as the battery is not removed.

Your computer has a new, enhanced security feature that provides extra protection for your administrator password, as well as your startup (boot) sequence settings. With enhanced security, your administrator password and boot sequence are stored in a highly-protected, nonvolatile, security EEPROM module that is separate from CMOS memory and the EEPROM module that stores system programs. (Refer to “System Programs” on page 26 for information on system programs.) When your administrator password and boot sequence are locked in the security EEPROM, they remain intact even if the battery in your computer expires or is removed by someone.

Enhanced security can only be enabled or disabled when you update system programs. The procedure for enabling enhanced security is explained under “Enabling and Disabling Enhanced Security” on page 48.

If enhanced security is enabled and you have not set an administrator password, your computer will operate as if enhanced security were disabled. If enhanced security is enabled and you have set an administrator password, your computer will operate as follows:

- The contents of the security EEPROM (your administrator password and boot sequence) will be protected from failure of the battery and CMOS memory.
- The security EEPROM will be protected from unauthorized access because it locks after your computer is turned on and the system programs have completed their startup routine. Once it is locked, the security EEPROM cannot be read from or written to by any software application or system software until

the computer is turned off and back on again. In a networking environment, this might prevent certain functions from being performed remotely on your computer.

There is an extra measure of protection for the system programs in your computer. Normally, the entire content of the system programs EEPROM is write-protected with a soft lock. A soft lock allows the POST/BIOS update utility to function in a network environment. Enhanced security adds a hard lock. This means that after your computer is turned on and the system programs startup routine is completed, the POST/BIOS update utility is locked and cannot be unlocked until the computer is turned off and back on again and the administrator password is entered. Note that, in a networking environment, this prevents the system programs in your PC from being updated remotely. Someone must be present at your computer to turn it on and off in order to unlock the POST/BIOS update utility.

- A chassis-intrusion feature will alert you if the cover of your computer has been removed. This feature will work if your computer is on or off when the cover is removed. If the cover has been removed, a prompt for your administrator password will appear on the screen, and your PC will remain in a halted state until your administrator password is entered.
- As with nonenhanced security, your configuration settings are protected. The settings cannot be changed in the Configuration/Setup Utility program until your administrator password is entered. This means that any changes in computer hardware that are detected by the system programs in your computer, such as removal of a memory DIMM, will generate a configuration error until the administrator password is entered.

Enabling and Disabling Enhanced Security

Enhanced security can be enabled or disabled only when you update the system programs in your PC.

To enable or disable enhanced security:

1. Insert a system programs update diskette into drive A of your computer. System programs updates are available on the World Wide Web. (Refer to “System Programs” on page 26 for further information on updates.)
2. Turn on the computer. If it is on already, you must turn it off and back on again.
3. While the update diskette is starting, your computer will halt and prompt for your administrator password. The computer will remain in a halted state until the administrator password is entered.

4. When the administrator password is entered, the update diskette will continue to run, and you will be given the option of enabling or disabling enhanced security. Your choice will automatically be recorded in the System Security menu of the Configuration/Setup Utility program.

Setting, Changing, and Deleting an Administrator Password Protected by Enhanced Security

To set, change, or delete an administrator password protected by enhanced security, do the following:

1. Turn off all attached devices and the computer.
2. Refer to *Installing Options in Your Personal Computer* for instructions on safety, disconnecting all cables attached to the computer, and removing the computer cover.
3. Locate the security switch (marked as 7) on the system board. Refer to the system board label inside the computer cover for the location of the switch. Move the switch to the **ON** position. (To do this, push on the **ON** side.)
4. Set, change, or delete your administrator password in the Configuration/Setup Utility program. Refer to “Setting and Changing an Administrator Password” on page 45 or “Deleting an Administrator Password” on page 46 for instructions.
5. Move the switch back to the **OFF** position after you have set, changed, or deleted your password.
6. Replace the cover, and then turn on the computer.

Erasing a Lost or Forgotten Administrator Password Protected by Enhanced Security

When enhanced security is enabled, it is vital that you keep a record of your administrator password in a secure place. If you forget or lose the administrator password, the system board in your computer must be replaced in order to regain access to the Configuration/Setup Utility program.

Advanced Power Management

Your computer comes with built-in energy-saving capabilities. You can view and change energy-saving settings using the Advanced Power Management menu in the Configuration/Setup Utility program. This section describes the Advanced Power Management features in your computer and provides instructions for using these features.

Attention: If a device, such as a monitor, does not have power-management capabilities, it might be damaged when exposed to a reduced-power state. Before you make energy-saving selections for your monitor, check the documentation that comes with your monitor to see if it supports Display Power Management Signaling (DPMS).

Automatic Hardware Power Management Features

With Automatic Hardware Power Management, you can have the computer, microprocessor, and monitor (if the monitor supports DPMS) go into reduced-power states if they are inactive for a certain length of time.

There are three levels of power management. For each level, you can specify the amount of time that the computer must be inactive before the power management options take effect. For Level 1, you can select 5 minutes to 4 hours; for Level 2, you can select 10 minutes to 5 hours; and for Level 3, you can select 15 minutes to 6 hours. At each level, you can define the amount of energy savings by specifying values for the following options.

- **System Power:** With this option, you can select **On** if you want the computer to remain on, or **Off** if you want the computer to shut down.
- **Processor Speed:** With this option, you can set your microprocessor to run at a percentage of its internal clock speed (such as, 25 or 50 percent), or you can disable the microprocessor entirely. Any computer activity returns the microprocessor to full speed.
- **Display:** With this option, you can select one of the following reduced-power states or the off state:
 - **Standby:** In this mode, the screen is blanked, but the screen image is restored *immediately* when any keyboard or mouse activity is detected.
 - **Suspend:** In this mode, the monitor uses less power than in Standby mode. The screen is blanked, but the screen image is restored *after a slight delay* when any keyboard or mouse activity is detected.
 - **Off:** In this mode, the monitor power is turned off. To restore power to the monitor, you must press the monitor power switch. On some monitors, you might have to press the power switch twice. Some monitors might not support the Off mode.
- **Hard Disk Drive:** With this option, you can enable the hard disk drive to “spin down” (shut down the drive motor) after about 20 minutes of inactivity on the drive. When you attempt to read from or write to the hard disk, the spindle starts back up within a few seconds. This feature can be activated in PC models with EIDE hard disk drives, but not in models with SCSI hard disk drives. (In

models with SCSI hard disk drives, the feature is set to **Enabled** by default, but it is not operational.)

Setting Automatic Hardware Power Management Features: To set Automatic Hardware Power Management features, complete the following steps.

1. Start the Configuration/Setup Utility program (see “Starting the Configuration/Setup Utility Program” on page 34).
2. Select **Advanced Power Management** from the Configuration/Setup Utility program menu.
3. Be sure **APM BIOS Mode** is set to **Enabled**. If it is not, press Left Arrow (←) or Right Arrow (→) to change the setting.
4. Select **Automatic Hardware Power Management**.
5. Set **Automatic Hardware Power Management** to **Enabled**.
6. Select values for the three levels of power management (system power, processor speed, and display), as necessary.
7. Set **Hard Disk** to **Enabled** or **Disabled**.
8. Refer to “Exiting from the Configuration/Setup Utility Program” on page 37 for instructions on saving your settings and exiting from the Configuration/Setup Utility program.

Automatic Power-On Features

The Automatic Power-On features within the Advanced Power Management menu allow you to enable and disable features that turn your computer on automatically.

- **Serial Port Ring Detect:** If your computer has an *external* modem connected to serial port 1 and you want the computer to turn on automatically when a ring is detected on the modem, set this feature to **Enabled**.
- **Modem Ring Detect:** If your computer has an *internal* modem and you want the computer to turn on automatically when a ring is detected on the modem, set this feature to **Enabled**.
- **Wake Up on Alarm:** With this feature, you can specify a date and time at which the computer will be turned on automatically. This can be either a single event or a daily event.
- **Wake on LAN:** If your computer has a properly configured Ethernet LAN connection and you have network-management software, you can use the Wake on LAN feature. When you set Wake on LAN to **Enabled**, your computer will turn on when it receives a specific signal from another computer over the LAN.

For additional information on this setting, refer to “Using System-Management Features” on page 25 and “Wake on LAN” on page 54.

Note: To use Wake on LAN with an optional network adapter, the adapter must support Wake on LAN and be properly configured.

Setting Automatic Power-On Features: To set Automatic Power-On features, complete the following steps.

1. Start the Configuration/Setup Utility program (see “Starting the Configuration/Setup Utility Program” on page 34).
2. Select **Advanced Power Management** from the Configuration/Setup Utility program menu.
3. Select **Automatic Power On**.
4. Select the menu item for which you want to view or change settings. Use Left Arrow (←) or Right Arrow (→) to toggle between selections.
5. Refer to “Exiting from the Configuration/Setup Utility Program” on page 37 for instructions on saving your settings and exiting from the Configuration/Setup Utility program.

System-Management Settings

This section, which describes how to configure the network interface in your computer, is intended primarily for network administrators. For further information on the system-management capabilities of your computer, refer to “Using System-Management Features” on page 25.

The Configuration/Setup Utility program includes settings that can be enabled and disabled to configure the network interface in your computer. These settings are:

- Ethernet Support
- Remote Program Load (RPL) or Dynamic Host Configuration Protocol (DHCP)
- Automatic Power-On Startup Sequence
- Wake on LAN
- Update POST/BIOS from Network

You can also view the MAC (media access control) address for the integrated Ethernet controller of your computer in the Configuration/Setup Utility program. To access the MAC address, select **Devices and I/O Ports** from the Configuration/Setup Utility program menu, and then select **Ethernet Setup**. You can view but not change the MAC address setting.

Instructions for accessing the other system-management settings in the Configuration/Setup Utility program follow.

Ethernet Support

This setting is used to enable or disable the integrated Ethernet controller in your computer. The setting is enabled by default. You might want to disable this setting to free system resources if you install an optional network adapter and do not want to use the integrated Ethernet controller, or if your computer is not linked to a network.

To access the Ethernet Support setting, select **Devices and I/O Ports** and then **Ethernet Setup** from the Configuration/Setup Utility program menu.

RPL and DHCP

The remote program load (RPL) feature enables your computer to start from a server on your LAN that has been configured for RPL. Network-management software, such as LANClient Control Manager, is required to take advantage of RPL.

The dynamic host configuration protocol (DHCP) feature makes it possible for a DHCP server on your intranet to assign an IP (internet protocol) address to your computer so that a boot image can be loaded onto your PC from an intranet server. The DHCP server must be one, such as the Intel LAN Desk Configuration Manager, that supports Boot P (Boot Protocol) on your intranet.

You can use RPL and DHCP in conjunction with the integrated Ethernet controller, or in conjunction with an optional network adapter, but not with both. If you install an optional network adapter, disable **Ethernet Support** in the Configuration/Setup Utility program if you want to use the RPL or DHCP features of the optional adapter. See “Ethernet Support” for information on disabling the integrated Ethernet controller.

To enable or disable RPL or DHCP, complete the following steps:

1. Start the Configuration/Setup Utility program (see “Starting the Configuration/Setup Utility Program” on page 34).
2. Select **Devices and I/O Ports** from the Configuration/Setup Utility program menu.
3. Select **Ethernet Setup**.

4. Set Network Boot to **RPL** or **DHCP** if you want to use RPL or DHCP. Select **Disabled** if you do not want to start an operating system from the network. Use Left Arrow (←) or Right Arrow (→) to toggle between selections.
5. In the same menu, check to make sure that **Ethernet Support** is set to **Enabled**, which is the default setting.
6. Press **Esc** until you return to the Configuration/Setup Utility program menu.
7. Select **Start Options**, and then select **Startup Sequence**. You must include the **Network** setting somewhere in your startup sequence. Use Left Arrow (←) or Right Arrow (→) to toggle between selections.
8. Refer to “Exiting from the Configuration/Setup Utility Program” on page 37 for instructions on saving your settings and exiting from the Configuration/Setup Utility program.

Note: When you are using the RPL and DHCP features, you might encounter error messages specific to the integrated Ethernet subsystem. If this happens, record the error message and report the problem to your network administrator. Also, information about these error messages is documented in “Error Messages Specific to the Integrated Ethernet” on page 97 .

Automatic Power-On Startup Sequence

The Automatic Power-On Startup Sequence settings are used when your computer is to be powered on automatically by a method other than the power switch. These settings are used in conjunction with the automatic power-on features in your computer (Serial Port Ring Detect, Modem Ring Detect, Wake on Alarm, and Wake on LAN). For additional information on the automatic power-on features, see page 51.

To access the Automatic Power-On Startup Sequence settings, select **Start Options** from the Configuration/Setup Utility program menu, and then select **Startup Sequence**.

Wake on LAN

This setting is used to enable or disable the Wake on LAN feature, which makes it possible for your computer to be powered-on from a remote computer. Remote network management software (such as IBM LANClient Control Manager, NetFinity, or Intel LAN Desk) must be used in conjunction with this feature.

To access the Wake on LAN setting, select **Advanced Power Management**, and then select **Automatic Power On** from the Configuration/Setup Utility program menu.

Note: To use Wake on LAN with an optional network adapter:

- The network adapter must be properly configured, Wake on LAN enabled (using the Configuration/Setup Utility program), and connected to the riser card connector (using the appropriate cable). For instructions on installing an adapter, refer to *Installing Options in Your Personal Computer*.
- Integrated Ethernet must be disabled through the Ethernet disable switch on the system board. (Refer to the system board label inside the computer cover for the location of the switch.)

Update POST/BIOS from Network

This setting is used to enable or disable the Update POST/BIOS from Network feature. When the feature is enabled, the system programs in your PC can be updated remotely by a network administrator from a management console. (For background information on the system programs in your computer, refer to “System Programs” on page 26.)

The system programs in your computer can be updated remotely only if the following requirements are met:

- Update POST/BIOS from Network must be enabled. To access the Update POST/BIOS from Network setting, select **System Security** from the Configuration/Setup Utility program menu, and then select **POST/BIOS Update**.
- Enhanced security must be disabled. (Enhanced security is disabled by default. If you have enabled enhanced security, refer to “Enabling and Disabling Enhanced Security” on page 48 for instructions on disabling it.)
- Your computer must be started by a means other than the power switch (such as a modem, timer, or Wake on LAN).
- Your computer must be engaged in a remote program load. For information on remote program load, refer to “RPL and DHCP” on page 53.

If you have set an administrator password, it does not have to be entered for the Update POST/BIOS from Network feature to work.

Chapter 5. Taking Care of Your Computer

This chapter provides guidelines for the proper handling and care of your computer.

Basics

Here are some basic points about keeping your computer functioning properly:

- Keep your computer in a clean, dry environment. Make sure it rests on a flat, sturdy surface.
- Do not place items on top of the monitor or cover any of the vents in the monitor or computer. These vents provide air flow to keep your computer from overheating.
- Keep food and drinks away from all parts of your computer. Food particles and spills might make the keyboard and mouse sticky and unusable.
- Do not get the power switches or other controls wet. Moisture can damage these parts and cause an electrical hazard.
- Always disconnect a power cord by grasping the plug, not the cord.

Cleaning Your Computer

It is a good practice to clean your computer periodically to protect the surfaces and ensure trouble-free operation.

CAUTION:

Be sure to turn off the computer and monitor power switches before cleaning the computer and monitor screen.

Computer and Keyboard

Use only mild cleaning solutions and a damp cloth to clean the painted surfaces of the computer.

Monitor Screen

Do not use abrasive cleaners when cleaning the surface of the monitor screen. The screen surface is easily scratched, so avoid touching it with pens, pencil points, and erasers.

To clean the screen surface, wipe it gently with a soft, dry cloth, or blow on the screen to remove grit and other loose particles. Then use a soft cloth moistened with a nonabrasive liquid glass cleaner. In addition, an anti-static cleaner can be used to slow the buildup of dust on the screen surface.

Mouse

If the pointer on the screen does not move smoothly with the mouse, you might need to clean the mouse.

1. Turn off the computer.
2. Disconnect the mouse cable from the computer.
3. Turn the mouse upside down. Unlock the retainer on the bottom of the mouse by moving it in the direction indicated by the arrow on the retainer.

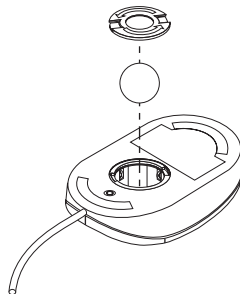

4. Turn the mouse right-side up, and the retainer and ball will drop out.
5. Wash the ball in warm, soapy water, and dry it well.
6. Using a damp cloth, wipe the outside of the mouse and the retainer. Be sure to wipe the rollers inside the mouse.
7. Insert the ball and retainer. Lock the retainer by moving it in the opposite direction of the arrow.
8. Reconnect the mouse cable to the computer.

Replacing the Battery

Your computer has a special type of memory that maintains the date, time, and the settings for built-in features, such as serial- and parallel-port assignments (configuration). A battery keeps this information active when you turn off the computer.

The battery requires no charging or maintenance throughout its life; however, no battery lasts forever. If the battery fails, the date, time, and configuration information (including passwords) are lost. An error message is displayed when you turn on the computer.

Refer to “Lithium Battery Notice” on page vii of this publication and *Installing Options in Your Personal Computer* for information about replacing the battery.

If you replace the original lithium battery with a heavy-metal battery or a battery with heavy-metal components, be aware of the following environmental consideration. Batteries and accumulators that contain heavy metals must not be disposed of with normal domestic waste. They will be taken back free of charge by the manufacturer, distributor, or representative, to be recycled or disposed of in a proper manner.

Moving Your Computer

Important

Do not move the computer while it is on. Sudden movements, such as bumps, jerks, and drops, can cause the read/write head of the hard disk drive to bounce against the surface of the disk itself. This can cause loss of data and a variety of hard disk errors. Always turn off the computer before you move it. When the computer is off, the read/write head automatically parks itself over a nondata area of the hard disk. This process can help to prevent damage to the hard disk.

CAUTION:

Do not risk injury by moving or lifting the computer by yourself. Ask another person to help you.

If your computer has a hard disk drive, take the following precautions:

1. Back up all files and data from the hard disk.

Operating systems can vary in the way they perform backup procedures. Some operating systems save only data files, while others make copies of application

program files *and* data files. Refer to your operating-system documentation for information about software backup.

2. Remove all media (diskettes, compact discs, tapes, and so on) from the drives.
3. Turn off the computer and all attached devices.
4. Unplug the power cords from electrical outlets.
5. Note where you have attached your cables to the rear of the computer; then remove them.
6. If you saved the original shipping cartons and packing materials, use them to pack the units. If you are using different cartons, cushion the units to avoid any damage.

Chapter 6. Solving Problems

This chapter presents an overview of diagnostic tools available to you. You can use these tools to identify and correct problems that might come up as you use your computer. This chapter also contains information about option diskettes and terminate-and-stay-resident (TSR) programs.

Important

If you have just added new software or a new computer option and your computer is not working, do the following before using the other information in the chapter:

- Remove the software or device you just added.
- Run the diagnostic programs to determine if your computer is running correctly. (See “Diagnostic Programs” on page 95 for information about diagnostic programs provided with your computer.)
- Reinstall the new software or new device.

Using Diagnostic Tools

Computer problems can be caused by hardware, software, or user error (for example, pressing the wrong key). Using the diagnostic aids discussed in this chapter, you might be able to solve such problems yourself or gather helpful information you can pass on to a service technician.

You can check the hardware by following the procedures in this chapter. You can also use the diagnostic programs provided with your computer (see “Diagnostic Programs” on page 95 for a description of these programs).

If the hardware checks out OK, and you have not made a user error, you might have a software problem. If you suspect that you have a software problem and your computer came with IBM-preinstalled software, refer to *About Your Software* and the operating-system documentation that comes with your computer. If you have installed software applications yourself, consult the documentation that comes with the software.

The following tools are available to diagnose hardware-related problems:

- Power-on self-test (POST)
- Error messages
- POST message charts
- Troubleshooting charts
- Diagnostic programs

Note: In addition to the preceding tools, if you have access to the World Wide Web, you can also view or download the latest problem-solving Tips from the <http://www.us.pc.ibm.com/cdt/> Web site.

Descriptions of the diagnostic tools follow.

Power-On Self-Test (POST)

Each time you turn on your computer, it performs a series of tests that check the operation of the base computer. This series of tests is called the *power-on self-test (POST)*.

Note

If your computer starts but does not boot when you press the power switch, do the following:

- Make sure all cables are securely connected to the correct locations.
- Check to see if the voltage-selection switch is set to the correct position for your country.

For additional information, see *Setting Up Your Personal Computer*.

POST does the following:

- Checks basic system-board operations
- Checks the memory operation
- Compares the current system configuration with that established by the Configuration/Setup Utility program
- Starts the video operation
- Verifies the presence of diskette drives, hard disk drives, and the CD-ROM drive (if installed)

As POST starts, numbers showing the amount of memory being tested appear in the top-left corner of the screen until the total amount of memory in the system is

reached. In addition, numbers representing various steps during the startup sequence appear in the top-right corner of the screen; these numbers can be useful to support personnel if a “hang” condition occurs during POST. Options for running a fast POST or accessing the Configuration/Setup Utility program appear in the lower-left corner of the screen.

Note: The amount of available memory shown might be somewhat less than expected because of basic input/output system (BIOS) shadowing in random access memory (RAM).

If POST finishes without detecting any problems, you will hear one beep and the first screen of your operating system or application program appears (if you have not set a power-on password). If you have set a power-on password, a password prompt appears. You must enter your password in order for the first screen of your operating system or application program to appear. (For further information on using passwords, refer to “Passwords” on page 40.)

If POST detects a problem, you will hear multiple beeps or no beep. In most cases, an error code appears in the top-left corner of the screen, and in some cases a description of the error is displayed beside the code. (Note that the screen will sometimes display multiple error codes and descriptions.) For more information about what caused an error message to appear and what action to take, refer to “Solving POST Error Message Problems” on page 64 and “POST Message Charts” on page 67.

If you hear no beep at all during POST, refer to “Troubleshooting Charts” on page 85. You might need to have your computer serviced.

Error Messages

Error messages that appear on the screen might be text, numeric, or both. There are several types of error messages:

- POST error messages

Messages that appear when POST finds problems with the hardware during startup or when a change in the hardware configuration is found. POST error messages are 3-, 4-, 5-, 8-, or 12-character alphanumeric messages and include brief explanations (except I999XXXX errors).

For more information about what caused an error message to appear and what action to take, refer to “Solving POST Error Message Problems” on page 64 and “POST Message Charts” on page 67.

- SCSI error messages

Messages that appear if a problem or conflict is detected by the SCSI host adapter that is preinstalled in some PC models. If your PC has a preinstalled SCSI adapter, refer to the SCSI documentation that comes with your computer for information about these messages.

- Software-generated error messages

Messages that appear if a problem or conflict is detected by the application program, the operating system, or both. Error messages for operating-system and other software problems are generally text messages, but they also can be numeric messages. For information about these software error messages, refer to the information that comes with the operating system or application program.

- Diagnostic error messages

Messages that appear if a hardware problem is detected by a diagnostic test program. The messages present text information that can be used to identify a failing part.

- Integrated Ethernet-specific error messages

Messages that appear if a problem arises with the integrated Ethernet and the RPL or DHCP environments. These messages are specific to the integrated Ethernet controller and software code of your computer.

Solving POST Error Message Problems: If you receive an error message during the power-on-self-test (POST), completing the steps outlined in this section might enable you to resolve the problem.

Note

If you have just added, removed, or changed the location of a device and you receive an error message, follow the procedure described in the **Important** text box on page 34. If the procedure on page 34 does not eliminate the error message, then proceed with the following instructions.

1. Write down all error code numbers and descriptions that appear on the screen as you start your computer. (Note that a single problem can cause several error messages to appear. When you correct the cause of the first error message, the other error messages probably will not appear on the screen the next time you turn on your computer.)
2. If you have set a power-on password, a password prompt appears. (You must wait approximately one minute after the memory-count numbers stop cycling in the top-left corner of the screen for the password prompt to appear.) If you

have set both power-on and administrator passwords, you can type either password at the password prompt. However, if you think you might need to change any settings in the Configuration/Setup Utility program, type your administrator password at the password prompt. If you type your power-on password, you will be able to view error codes and error code descriptions displayed on the POST Startup Errors screen, and you will also be able to view limited information in the Configuration/Setup Utility program. However, you will not be able to change any settings.

3. In the case of most errors, the Configuration/Setup Utility program starts automatically so that you can attempt to identify and correct the problem. When the Configuration/Setup Utility program starts, a screen labeled POST Startup Errors appears. (Note that the POST Startup Errors screen does not appear immediately. You must wait approximately one minute.) If the POST Startup Errors screen does not appear, proceed to step 6.
4. At the POST Startup Errors screen, select **Continue** if you want to access the Configuration/Setup Utility program menu. Select **Exit Setup** if you want to exit the Configuration/Setup Utility program. (See the following **Important** text box for information on exiting the Configuration/Setup Utility program without making any changes to current settings.) To select an item, press Up Arrow (↑) or Down Arrow (↓) to highlight the item, and then press **Enter**.

Important

If you exit from the Configuration/Setup Utility program without selecting **Save Settings**, your operating system will not start, but the computer will automatically restart. When the computer restarts, you will get a POST error message, and then the Configuration/Setup Utility program will again start automatically.

If you select **Save Settings** and then exit the Configuration/Setup Utility program, your system will save all settings as they currently appear in the Configuration/Setup Utility program and your operating system will start (unless there is an unresolved problem with an IDE device).

5. If you selected **Continue** in step 4, the Configuration/Setup Utility program menu appears on the screen. You will see a pointer next to any menu items that are malfunctioning or that have been changed since the last time you turned on your computer. If you did not knowingly make a change to a flagged menu item, there is likely a malfunction in that item. If you made a change, continue here. If you did not make a change, go to the **Important** text box on page 65.

To use the Configuration/Setup Utility program, do the following:

- a. Select the menu item that is flagged (or that you wish to view) by pressing Up Arrow (↑) or Down Arrow (↓), and then press **Enter**.
 - b. A new menu specific to the item that you selected appears. Press Left Arrow (←) or Right Arrow (→) to toggle between choices for a menu item. (Note that each menu item has a Help screen. To view the Help screen, select the menu item, and then press **F1**.)
 - c. When you have finished viewing and changing settings, press **Esc** to return to the Configuration/Setup Utility program menu.
 - d. Before you exit from the program, select **Save Settings**.
 - e. To exit from the Configuration/Setup Utility program, press **Esc** and follow the instructions on the screen. When you exit from the Configuration/Setup Utility program menu, your new settings will be saved and your operating system will start automatically (unless there is an unresolved problem with an IDE device).
6. For more information about what caused an error message to appear and what action to take, refer to the following chart.

Problem	Go to:
POST error code or message appears.	“POST Message Charts” on page 67.
After more than one beep, application program or operating system appears.	“Diagnostic Programs” on page 95.
Blank screen, unreadable screen, or other unusual response occurs.	“Troubleshooting Charts” on page 85.

If you are unable to resolve a problem and need assistance, refer to Chapter 7, “Getting Help, Service, and Information” on page 99.

POST Message Charts

The computer might display more than one error message. Often, the first error to occur causes subsequent errors. When using the POST message charts in this section, always begin by following the suggested action for the *first* error message that appears on your computer screen. Note that, in these charts, “X” can be any alphanumeric character.

Important

If you find it necessary to remove the computer cover, first read "Removing the Cover" in *Installing Options in Your Personal Computer* for important safety information and instructions.

POST Message	Description
101 102	A failure occurred during testing of the system board and microprocessor. Action: Have the computer serviced.
114	An adapter read-only memory (ROM) error occurred. Action: Remove all adapters that are not required for system startup and reinstall them one at a time, retesting after each is reinstalled. When an adapter fails, replace it. If the problem cannot be isolated and corrected, have the computer serviced.
121	A hardware error occurred. Action: Have the computer serviced.
161	The battery on the system board is dead. CAUTION: Danger of explosion if lithium battery is incorrectly replaced. Replace the battery with the same or equivalent type recommended by the manufacturer. Dispose of batteries as required by local ordinances or regulations. (See “Lithium Battery Notice” on page vii and “Replacing the Battery” on page 59 for important information on battery use, disposal, and replacement.) Action: Replace the battery. Note: The computer can be used until you replace the battery.

POST Message	Description
162	<p data-bbox="431 600 1081 657">A change in device configuration occurred. This message is displayed under one or more of the following conditions:</p> <ul data-bbox="444 674 1097 1003" style="list-style-type: none"> <li data-bbox="444 674 829 699">• A new device has been installed. <li data-bbox="444 716 1081 772">• A device has been moved to a different location or cable connection. <li data-bbox="444 789 1097 814">• A device has been removed or disconnected from a cable. <li data-bbox="444 831 1052 888">• A device is failing and is no longer recognized by the computer as being installed. <li data-bbox="444 905 862 930">• An external device is not turned on. <li data-bbox="444 947 1027 1003">• An invalid checksum is detected in CMOS memory (nonvolatile RAM). <p data-bbox="431 1020 509 1045">Action:</p> <ol data-bbox="444 1062 1154 1623" style="list-style-type: none"> <li data-bbox="444 1062 1154 1119">1. Verify that all external devices are turned on. External devices must be turned on before the computer is turned on. <li data-bbox="444 1136 1092 1192">2. Verify that all devices are properly installed and securely connected. <li data-bbox="444 1209 1154 1350">3. If you added, removed, or changed the location of a device, you must save the new configuration in the Configuration/Setup Utility program. Refer to the Important text box on page 34 for further information and instructions on saving the configuration. <li data-bbox="444 1367 1154 1455">4. If you added or changed a microprocessor, you must update system programs. Refer to “System Programs” on page 26 for instructions. <li data-bbox="444 1472 1154 1623">5. If you did not add, remove, or change the location of a device, a device is probably failing. Running the diagnostic programs might isolate the failing device. (See “Diagnostic Programs” on page 95 for information about diagnostic programs provided with your computer.) <p data-bbox="431 1640 1154 1692">If the problem cannot be isolated and corrected, have the computer serviced.</p>

POST Message	Description
163	<p>The clock is not working correctly.</p> <p>Action: Set the correct date and time. If the date and time are set correctly and saved and the 163 error message reappears, replace the battery.</p> <p>If this does not correct the problem, have the computer serviced.</p> <p>Note: The computer can be used until it is serviced, but any application programs that use the date and time will be affected.</p>
164	<p>A change in the memory configuration occurred. This error can be caused by adding, removing, or incorrectly installing memory.</p> <p>Note: The computer can be used with decreased memory capacity until the error is corrected.</p> <p>Action:</p> <ol style="list-style-type: none"> 1. If you added memory, see <i>Installing Options in Your Personal Computer</i> and “Using the Configuration/Setup Utility Program” on page 33 of this booklet to verify that the new memory is correct for your computer, and that it is installed and configured correctly. 2. If you added or removed memory, you must save the new configuration in the Configuration/Setup Utility program. Refer to the Important text box on page 34 for further information and instructions on saving the configuration. 3. Running the diagnostic programs might isolate the location of the problem DIMM and provide additional information. (See “Diagnostic Programs” on page 95 for information about diagnostic programs provided with your computer.) <p>If the problem cannot be isolated and corrected, have the computer serviced.</p>
175	<p>The primary copy of secure data is damaged. This can occur if the computer is turned off while the Configuration/Setup Utility program is updating the administrator password or startup sequence.</p> <p>Action: POST will attempt to use the alternate copy of secure data to correct the primary copy. If the operation is successful, the administrator password and startup sequence will remain as they were before the Configuration/Setup Utility program was invoked and this error will not appear during the next power-on. If the operation is not successful, other POST errors might appear and the system board must be replaced.</p>

POST Message	Description
176	<p>The computer was tampered with. This indicates that the cover has been removed and the chassis-intrusion detector has not been cleared by entering the administrator password. Note that chassis-intrusion can be detected only if the chassis-intrusion detector feature is activated, which occurs when enhanced security is enabled and an administrator password is set.</p> <p>Action: To reset the chassis-intrusion detector, you must enter the administrator password.</p>
186	<p>Security hardware control logic error. The security data could either not be read or written and the administrator password and startup sequence are not reliable.</p> <p>Action: If your computer is in enhanced security mode, the startup process will not continue. The system board must be replaced.</p>
187	<p>A problem occurred with the administrator password and startup (boot) sequence.</p> <p>Action: If enhanced security is not enabled, use the Configuration/Setup Utility program to:</p> <ol style="list-style-type: none"> 1. Clear the startup sequence (Start Options, Startup sequence). 2. Clear the administrator password. For instructions, see “Deleting an Administrator Password” on page 46. 3. Reload the default settings (Load Default Settings). 4. Reset an administrator password. For instructions, see “Setting and Changing an Administrator Password” on page 45. <p>For instructions on using the Configuration/Setup Utility program, see “Using the Configuration/Setup Utility Program” on page 33.</p>
190	<p>The computer chassis-intrusion detector was cleared.</p>

POST Message	Description
20X	<p>A failure occurred during testing of the memory. This error can be caused by incorrectly installed memory, a failing DIMM, or a system-board failure.</p> <p>Action:</p> <ol style="list-style-type: none"> 1. If you have added memory, see <i>Installing Options in Your Personal Computer</i> and “Using the Configuration/Setup Utility Program” on page 33 of this booklet to verify that the new memory is correct for your computer, and that it is installed and configured correctly. 2. Run the diagnostic programs to verify the problem. (See “Diagnostic Programs” on page 95 for information about diagnostic programs provided with your computer.) <p>If the problem cannot be isolated and corrected, have the computer serviced.</p>
301 303	<p>A failure occurred during testing of the keyboard and keyboard controller. These error messages also might be accompanied by continuous beeping.</p> <p>Action:</p> <p>Ensure that:</p> <ol style="list-style-type: none"> 1. Nothing is resting on the keyboard and pressing a key. 2. No key is stuck. 3. The keyboard cable is securely attached to the keyboard connector on the computer. (For the location of the keyboard connector, refer to “Connectivity” on page 10.) <p>Note: If you have just connected a new mouse or other pointing device, turn off the computer and disconnect that device. Wait at least 5 seconds, and then turn on the computer. If the error message goes away, replace the device. If the error message remains, have the keyboard and cable or the computer serviced.</p>

POST Message	Description
601	<p>A failure occurred during testing of the diskette drive and diskette-drive controller. This error can be caused by a loose or incorrectly connected cable, a failing drive, or a failing system board.</p> <p>Note: The computer can be used, but one or more diskette drives might not work.</p> <p>Action: Verify that all diskette drive cables are properly installed and securely connected.</p> <p>Running the diagnostic programs might isolate the diskette drive that failed, but you must have your computer serviced. (See “Diagnostic Programs” on page 95 for information about diagnostic programs provided with your computer.)</p>
602	<p>The computer is not able to start the diskette in the drive. The diskette might be damaged or formatted incorrectly.</p> <p>Action: Try another startable diskette that is formatted correctly and is in good condition. (For information and instructions on formatting diskettes, refer to <i>Understanding Your Personal Computer</i> and your operating-system documentation.)</p> <p>If this does not correct the problem, have the computer serviced.</p>
604	<p>A failure occurred during the testing of a diskette drive.</p> <p>Action:</p> <ol style="list-style-type: none"> 1. Verify that the Configuration/Setup Utility program correctly reflects the type of diskette drive you have installed. (For instructions on using the Configuration/Setup Utility program, refer to “Using the Configuration/Setup Utility Program” on page 33.) 2. Run the diagnostic programs. (See “Diagnostic Programs” on page 95 for information about diagnostic programs provided with your computer.) 3. If the diagnostic programs detect a failure, replace the diskette drive. <p>If the problem cannot be isolated and corrected, have the computer serviced.</p>

POST Message	Description
662	<p>A diskette drive configuration error occurred.</p> <p>Action:</p> <ol style="list-style-type: none"> 1. Verify that the Configuration/Setup Utility program correctly reflects the number of diskette drives you have installed. (For instructions on using the Configuration/Setup Utility program, refer to “Using the Configuration/Setup Utility Program” on page 33.) 2. If you installed or removed a diskette drive, you must save the new configuration in the Configuration/Setup Utility program. Refer to the Important text box on page 34 for further information and instructions on saving the configuration. <p>If this does not correct the problem, have the computer serviced.</p>
1762	<p>A hard disk configuration error occurred.</p> <p>Action:</p> <ol style="list-style-type: none"> 1. Verify that the Configuration/Setup Utility program correctly reflects the number of hard disk drives you have installed. (For instructions on using the Configuration/Setup Utility program, refer to “Using the Configuration/Setup Utility Program” on page 33.) 2. If you added or removed a hard disk drive, you must save the new configuration in the Configuration/Setup Utility program. Refer to the Important text box on page 34 for further information and instructions on saving the configuration. <p>If the problem cannot be isolated and corrected, have the computer serviced.</p>
178X	<p>A failure occurred during testing of the hard disk drive or a primary or secondary IDE device.</p> <p>Action:</p> <ol style="list-style-type: none"> 1. Run the diagnostic programs. (See “Diagnostic Programs” on page 95 for information about diagnostic programs provided with your computer.) 2. If the diagnostic programs detect a failure, replace the defective hard disk drive or primary or secondary IDE or EIDE device. <p>If the problem cannot be isolated and corrected, have the computer serviced.</p>

POST Message	Description
1800	<p data-bbox="431 596 1097 653">A PCI adapter has requested a hardware interrupt that is not available.</p> <p data-bbox="431 674 513 699">Action:</p> <ol data-bbox="444 720 1162 894" style="list-style-type: none"> <li data-bbox="444 720 1162 894">1. Make sure that settings for all ISA legacy adapters are correct in the Configuration/Setup Utility program. If the hardware interrupt settings are not correct, change and save the settings. Setting the resources used by ISA legacy adapters to Not available enables the Plug and Play function to configure around the legacy adapters. <p data-bbox="472 915 1162 1146">For background information on PCI, ISA, Plug and Play, and legacy (non-Plug and Play) adapters, refer to <i>Installing Options in Your Personal Computer</i>. For information about required interrupt resource settings for ISA legacy adapters, refer to the documentation that comes with these adapters. For instructions on using the Configuration/Setup Utility program, see “Using the Configuration/Setup Utility Program” on page 33.</p> <ol data-bbox="444 1167 1162 1619" style="list-style-type: none"> <li data-bbox="444 1167 1162 1251">2. Make sure that switches on all ISA legacy adapters are set correctly. For information about switch settings, refer to the documentation that comes with the ISA legacy adapters. <li data-bbox="444 1272 1162 1409">3. If all hardware interrupts are being used by ISA legacy adapters, you might need to remove an ISA legacy adapter to make an interrupt available to the PCI adapter you want to install. For instructions on removing adapters, see <i>Installing Options in Your Personal Computer</i>. <p data-bbox="472 1430 1162 1514">Note: If you remove an ISA legacy adapter, set the hardware interrupt used by the removed adapter to Available before installing another adapter.</p> <ol data-bbox="444 1535 1162 1619" style="list-style-type: none"> <li data-bbox="444 1535 1162 1619">4. If you have other PCI or Plug and Play adapters installed, you might need to remove one of these adapters to make an interrupt available to the PCI adapter you want to install. <p data-bbox="431 1640 1162 1694">If the problem cannot be isolated and corrected, have the computer serviced.</p>

POST Message	Description
1801	<p data-bbox="542 596 1195 653">A PCI adapter has requested memory resources that are not available.</p> <p data-bbox="542 674 623 699">Action:</p> <ol data-bbox="553 716 1260 890" style="list-style-type: none"> <li data-bbox="553 716 1260 890">1. Make sure that settings for all ISA legacy adapters are correct in the Configuration/Setup Utility program. If the memory resource settings are not correct, change and save the settings. Setting the resources used by ISA legacy adapters to Not available enables the Plug and Play function to configure around the legacy adapters. <p data-bbox="583 909 1268 1142">For background information on PCI, ISA, Plug and Play, and legacy (non-Plug and Play) adapters, refer to <i>Installing Options in Your Personal Computer</i>. For information about required memory resource settings for ISA legacy adapters, refer to the documentation that comes with these adapters. For instructions on using the Configuration/Setup Utility program, see “Using the Configuration/Setup Utility Program” on page 33.</p> <ol data-bbox="553 1161 1268 1619" style="list-style-type: none"> <li data-bbox="553 1161 1268 1247">2. Make sure that switches on all ISA legacy adapters are set correctly. For information about switch settings, refer to the documentation that comes with the ISA legacy adapters. <li data-bbox="553 1266 1268 1409">3. If all memory resources are being used by ISA legacy adapters, you might need to remove an ISA legacy adapter to make memory available to the PCI adapter you want to install. For instructions on removing adapters, see <i>Installing Options in Your Personal Computer</i>. <p data-bbox="583 1428 1243 1514">Note: If you remove an ISA legacy adapter, set the memory resources used by the removed adapter to Available before installing another adapter.</p> <ol data-bbox="553 1533 1268 1619" style="list-style-type: none"> <li data-bbox="553 1533 1268 1619">4. If you have other PCI or Plug and Play adapters installed, you might need to remove one of these adapters to make memory available to the PCI adapter you want to install. <p data-bbox="542 1638 1268 1682">If the problem cannot be isolated and corrected, have the computer serviced.</p>

POST Message	Description
1802	<p data-bbox="431 596 1162 655">A PCI adapter has requested an I/O address that is not available, or the PCI adapter might be defective.</p> <p data-bbox="431 672 513 697">Action:</p> <ol data-bbox="444 714 1162 1617" style="list-style-type: none"> <li data-bbox="444 714 1162 890">1. Make sure that settings for all ISA legacy adapters are correct in the Configuration/Setup Utility program. If the I/O address settings are not correct, change and save the settings. Setting the resources used by ISA legacy adapters to Not available enables the Plug and Play function to configure around the legacy adapters. For background information on PCI, ISA, Plug and Play, and legacy (non-Plug and Play) adapters, refer to <i>Installing Options in Your Personal Computer</i>. For information about required I/O resource settings for ISA legacy adapters, refer to the documentation that comes with these adapters. For instructions on using the Configuration/Setup Utility program, see “Using the Configuration/Setup Utility Program” on page 33. <li data-bbox="444 1159 1162 1247">2. Make sure that switches on all ISA legacy adapters are set correctly. For information about switch settings, refer to the documentation that comes with the ISA legacy adapters. <li data-bbox="444 1264 1162 1411">3. If all I/O addresses are being used by ISA legacy adapters, you might need to remove an ISA legacy adapter to make an I/O address available to the PCI adapter you want to install. For instructions on removing adapters, see <i>Installing Options in Your Personal Computer</i>. Note: If you remove an ISA legacy adapter, set the I/O address used by the removed adapter to Available before installing another adapter. <li data-bbox="444 1528 1162 1617">4. If you have other PCI or Plug and Play adapters installed, you might need to remove one of these adapters to make an I/O address available to the PCI adapter you want to install. <p data-bbox="431 1633 1162 1694">If the problem cannot be isolated and corrected, have the computer serviced.</p>

POST Message	Description
1803 1804	<p>A PCI adapter has requested a memory address that is not available, or the PCI adapter might be defective.</p> <p>Action:</p> <ol style="list-style-type: none"> 1. Make sure that settings for all ISA legacy adapters are correct in the Configuration/Setup Utility program. If the memory address settings are not correct, change and save the settings. Setting the resources used by ISA legacy adapters to Not available enables the Plug and Play function to configure around the legacy adapters. <p>For background information on PCI, ISA, Plug and Play, and legacy (non-Plug and Play) adapters, refer to <i>Installing Options in Your Personal Computer</i>. For information about required memory resource settings for ISA legacy adapters, refer to the documentation that comes with these adapters. For instructions on using the Configuration/Setup Utility program, see “Using the Configuration/Setup Utility Program” on page 33.</p> <ol style="list-style-type: none"> 2. Make sure that switches on all ISA legacy adapters are set correctly. For information about switch settings, refer to the documentation that comes with the ISA legacy adapters. 3. If all memory addresses are being used by ISA legacy adapters, you might need to remove an ISA legacy adapter to make a memory address available to the PCI adapter you want to install. For instructions on removing adapters, see <i>Installing Options in Your Personal Computer</i>. <p>Note: If you remove an ISA legacy adapter, set the memory address used by the removed adapter to Available before installing another adapter.</p> <ol style="list-style-type: none"> 4. If you have other PCI or Plug and Play adapters installed, you might need to remove one of these adapters to make a memory address available to the PCI adapter you want to install. <p>If the problem cannot be isolated and corrected, have the computer serviced.</p>
1805	<p>A PCI adapter read-only memory (ROM) error occurred.</p> <p>Action: Remove all of the PCI adapters that are not required for system startup and reinstall them one at a time, retesting after each is reinstalled. When an adapter fails, replace it.</p> <p>If the problem cannot be isolated and corrected, have the computer serviced.</p>

POST Message	Description
1850	<p data-bbox="431 596 1143 653">A Plug and Play adapter has requested a hardware interrupt that is not available.</p> <p data-bbox="431 674 509 699">Action:</p> <ol data-bbox="444 720 1143 1885" style="list-style-type: none"> <li data-bbox="444 720 1143 894">1. Make sure that settings for all ISA legacy adapters are correct in the Configuration/Setup Utility program. If the hardware interrupt settings are not correct, change and save the settings. Setting the resources used by ISA legacy adapters to Not available enables the Plug and Play function to configure around the legacy adapters. For background information on PCI, ISA, Plug and Play, and legacy (non-Plug and Play) adapters, refer to <i>Installing Options in Your Personal Computer</i>. For information about required interrupt resource settings for ISA legacy adapters, refer to the documentation that comes with these adapters. For instructions on using the Configuration/Setup Utility program, see “Using the Configuration/Setup Utility Program” on page 33. <li data-bbox="444 1163 1127 1251">2. Make sure that switches on all ISA legacy adapters are set correctly. For information about switch settings, refer to the documentation that comes with the ISA legacy adapters. <li data-bbox="444 1268 1143 1413">3. If all hardware interrupts are being used by ISA legacy adapters, you might need to remove an ISA legacy adapter to make an interrupt available to the Plug and Play adapter you want to install. For instructions on removing adapters, see <i>Installing Options in Your Personal Computer</i>. Note: If you remove an ISA legacy adapter, set the hardware interrupt used by the removed adapter to Available before installing another adapter. <li data-bbox="444 1535 1143 1644">4. If you have other PCI or Plug and Play adapters installed, you might need to remove one of these adapters to make an interrupt available to the Plug and Play adapter you want to install. <li data-bbox="444 1667 1127 1776">5. If your system will be loading a Plug and Play operating system, ensure that Plug and Play Operating System is set to Yes. See “Changing Plug and Play Control Features” on page 39 for more information. <li data-bbox="444 1799 1143 1885">6. Ensure that the address decode value for the adapter is properly set. See “Changing Plug and Play Control Features” on page 39 for more information. <p data-bbox="431 1902 1162 1959">If the problem cannot be isolated and corrected, have the computer serviced.</p>

POST Message	Description
1851	<p data-bbox="540 596 1268 653">A Plug and Play adapter has requested memory resources that are not available.</p> <p data-bbox="540 674 623 699">Action:</p> <ol data-bbox="553 716 1268 1854" style="list-style-type: none"> <li data-bbox="553 716 1268 894">1. Make sure that settings for all ISA legacy adapters are correct in the Configuration/Setup Utility program. If the memory resource settings are not correct, change and save the settings. Setting the resources used by ISA legacy adapters to Not available enables the Plug and Play function to configure around the legacy adapters. For background information on PCI, ISA, Plug and Play, and legacy (non-Plug and Play) adapters, refer to <i>Installing Options in Your Personal Computer</i>. For information about required memory resource settings for ISA legacy adapters, refer to the documentation that comes with these adapters. For instructions on using the Configuration/Setup Utility program, see “Using the Configuration/Setup Utility Program” on page 33. <li data-bbox="553 1163 1268 1251">2. Make sure that switches on all ISA legacy adapters are set correctly. For information about switch settings, refer to the documentation that comes with the ISA legacy adapters. <li data-bbox="553 1268 1268 1413">3. If all memory resources are being used by ISA legacy adapters, you might need to remove an ISA legacy adapter to make memory available to the Plug and Play adapter you want to install. For instructions on removing adapters, see <i>Installing Options in Your Personal Computer</i>. Note: If you remove an ISA legacy adapter, set the memory resources used by the removed adapter to Available before installing another adapter. <li data-bbox="553 1535 1268 1623">4. If you have other PCI or Plug and Play adapters installed, you might need to remove one of these adapters to make memory available to the Plug and Play adapter you want to install. <li data-bbox="553 1640 1268 1755">5. If your system will be loading a Plug and Play operating system, ensure that Plug and Play Operating System is set to Yes. See “Changing Plug and Play Control Features” on page 39 for more information. <li data-bbox="553 1772 1268 1854">6. Ensure that the address decode value for the adapter is properly set. See “Changing Plug and Play Control Features” on page 39 for more information. <p data-bbox="540 1871 1268 1917">If the problem cannot be isolated and corrected, have the computer serviced.</p>

POST Message	Description
1852	<p data-bbox="431 596 1149 653">A Plug and Play adapter has requested an I/O address that is not available, or the Plug and Play adapter might be defective.</p> <p data-bbox="431 674 509 701">Action:</p> <ol data-bbox="444 716 1149 1885" style="list-style-type: none"> <li data-bbox="444 716 1149 890">1. Make sure that settings for all ISA legacy adapters are correct in the Configuration/Setup Utility program. If the I/O address settings are not correct, change and save the settings. Setting the resources used by ISA legacy adapters to Not available enables the Plug and Play function to configure around the legacy adapters. For background information on PCI, ISA, Plug and Play, and legacy (non-Plug and Play) adapters, refer to <i>Installing Options in Your Personal Computer</i>. For information about required I/O resource settings for ISA legacy adapters, refer to the documentation that comes with these adapters. For instructions on using the Configuration/Setup Utility program, see “Using the Configuration/Setup Utility Program” on page 33. <li data-bbox="444 1163 1127 1247">2. Make sure that switches on all ISA legacy adapters are set correctly. For information about switch settings, refer to the documentation that comes with the ISA legacy adapters. <li data-bbox="444 1268 1154 1409">3. If all I/O addresses are being used by ISA legacy adapters, you might need to remove an ISA legacy adapter to make an I/O address available to the Plug and Play adapter you want to install. For instructions on removing adapters, see <i>Installing Options in Your Personal Computer</i>. Note: If you remove an ISA legacy adapter, set the I/O address used by the removed adapter to Available before installing another adapter. <li data-bbox="444 1535 1149 1646">4. If you have other PCI or Plug and Play adapters installed, you might need to remove one of these adapters to make an I/O address available to the Plug and Play adapter you want to install. <li data-bbox="444 1667 1149 1778">5. If your system will be loading a Plug and Play operating system, ensure that Plug and Play Operating System is set to Yes. See “Changing Plug and Play Control Features” on page 39 for more information. <li data-bbox="444 1799 1149 1885">6. Ensure that the address decode value for the adapter is properly set. See “Changing Plug and Play Control Features” on page 39 for more information. <p data-bbox="431 1898 1162 1957">If the problem cannot be isolated and corrected, have the computer serviced.</p>

POST Message	Description
1853 1854	<p data-bbox="540 598 1268 653">A Plug and Play adapter has requested a memory address that is not available, or the Plug and Play adapter might be defective.</p> <p data-bbox="540 674 623 699">Action:</p> <ol data-bbox="553 720 1255 1881" style="list-style-type: none"> <li data-bbox="553 720 1255 890">1. Make sure that settings for all ISA legacy adapters are correct in the Configuration/Setup Utility program. If the memory address settings are not correct, change and save the settings. Setting the resources used by ISA legacy adapters to Not available enables the Plug and Play function to configure around the legacy adapters. For background information on PCI, ISA, Plug and Play, and legacy (non-Plug and Play) adapters, refer to <i>Installing Options in Your Personal Computer</i>. For information about required memory resource settings for ISA legacy adapters, refer to the documentation that comes with these adapters. For instructions on using the Configuration/Setup Utility program, see “Using the Configuration/Setup Utility Program” on page 33. <li data-bbox="553 1163 1240 1247">2. Make sure that switches on all ISA legacy adapters are set correctly. For information about switch settings, refer to the documentation that comes with the ISA legacy adapters. <li data-bbox="553 1268 1255 1409">3. If all memory addresses are being used by ISA legacy adapters, you might need to remove an ISA legacy adapter to make a memory address available to the Plug and Play adapter you want to install. For instructions on removing adapters, see <i>Installing Options in Your Personal Computer</i>. Note: If you remove an ISA legacy adapter, set the memory address used by the removed adapter to Available before installing another adapter. <li data-bbox="553 1535 1263 1646">4. If you have other PCI or Plug and Play adapters installed, you might need to remove one of these adapters to make a memory address available to the Plug and Play adapter you want to install. <li data-bbox="553 1667 1247 1778">5. If your system will be loading a Plug and Play operating system, ensure that Plug and Play Operating System is set to Yes. See “Changing Plug and Play Control Features” on page 39 for more information. <li data-bbox="553 1799 1255 1881">6. Ensure that the address decode value for the adapter is properly set. See “Changing Plug and Play Control Features” on page 39 for more information. <p data-bbox="540 1902 1268 1948">If the problem cannot be isolated and corrected, have the computer serviced.</p>

POST Message	Description
1855	<p data-bbox="428 594 1166 625">A Plug and Play adapter read-only memory (ROM) error occurred.</p> <p data-bbox="428 638 1166 730">Action: Remove all of the Plug and Play adapters that are not required for system startup and reinstall them one at a time, retesting after each is reinstalled. When an adapter fails, replace it.</p> <p data-bbox="428 743 1166 806">If the problem cannot be isolated and corrected, have the computer serviced.</p>

POST Message	Description
1856	<p data-bbox="542 596 1268 653">A Plug and Play adapter has requested a DMA address that is not available.</p> <p data-bbox="542 674 623 699">Action:</p> <ol data-bbox="553 720 1268 1885" style="list-style-type: none"> <li data-bbox="553 720 1268 894">1. Make sure that settings for all ISA legacy adapters are correct in the Configuration/Setup Utility program. If the DMA address settings are not correct, change and save the settings. Setting the resources used by ISA legacy adapters to Not available enables the Plug and Play function to configure around the legacy adapters. For background information on PCI, ISA, Plug and Play, and legacy (non-Plug and Play) adapters, refer to <i>Installing Options in Your Personal Computer</i>. For information about required DMA resource settings for ISA legacy adapters, refer to the documentation that comes with these adapters. For instructions on using the Configuration/Setup Utility program, see “Using the Configuration/Setup Utility Program” on page 33. <li data-bbox="553 1163 1268 1251">2. Make sure that switches on all ISA legacy adapters are set correctly. For information about switch settings, refer to the documentation that comes with the ISA legacy adapters. <li data-bbox="553 1268 1268 1413">3. If all DMA addresses are being used by ISA legacy adapters, you might need to remove an ISA legacy adapter to make a DMA address available to the Plug and Play adapter you want to install. For instructions on removing adapters, see <i>Installing Options in Your Personal Computer</i>. Note: If you remove an ISA legacy adapter, set the DMA address used by the removed adapter to Available before installing another adapter. <li data-bbox="553 1535 1268 1644">4. If you have other PCI or Plug and Play adapters installed, you might need to remove one of these adapters to make a DMA address available to the Plug and Play adapter you want to install. <li data-bbox="553 1667 1268 1776">5. If your system will be loading a Plug and Play operating system, ensure that Plug and Play Operating System is set to Yes. See “Changing Plug and Play Control Features” on page 39 for more information. <li data-bbox="553 1799 1268 1885">6. Ensure that the address decode value for the adapter is properly set. See “Changing Plug and Play Control Features” on page 39 for more information. <p data-bbox="542 1902 1268 1959">If the problem cannot be isolated and corrected, have the computer serviced.</p>

POST Message	Description
1962	<p>A startup sequence error occurred.</p> <p>Action:</p> <ol style="list-style-type: none"> 1. Make sure the settings for startup options are correct in the Configuration/Setup Utility program. If the settings are not correct, change and save them. For instructions, see "Using the Configuration/Setup Utility Program" on page 33. 2. Make sure the primary IDE (or, if applicable, SCSI) cable is properly installed and securely connected. 3. Make sure all adapters are installed correctly. For instructions on adding adapters, see <i>Installing Options in Your Personal Computer</i>. <p>If the problem cannot be isolated and corrected, have the computer serviced.</p>
2462	<p>A video configuration error occurred.</p> <p>Action:</p> <ol style="list-style-type: none"> 1. Make sure the monitor signal cable is securely attached to the monitor connector. (For the location of the monitor connector, refer to "Connectivity" on page 10.) 2. If you just added or removed video memory, you must save the new configuration in the Configuration/Setup Utility program. Refer to the Important text box on page 34 for further information and instructions on saving the configuration. <p>If the problem cannot be isolated and corrected, have the computer serviced.</p>
I9990301	<p>A hard disk failure occurred.</p> <p>Action: Have the computer serviced.</p>
Other Numbers	<p>The computer POST found an error.</p> <p>Action: Follow the instructions on the screen.</p>

Troubleshooting Charts

You can use the troubleshooting charts in this section to find solutions to problems that have definite symptoms.

Important

- If you find it necessary to remove the computer cover, first read "Removing the Cover" in *Installing Options in Your Personal Computer* for important safety information and instructions.
- If you have just added new software or a new computer option and your computer is not working, do the following before using the troubleshooting charts:
 - Remove the software or device you just added.
 - Run the diagnostic programs to determine if your computer is running correctly. (See "Diagnostic Programs" on page 95 for information about diagnostic programs provided with your computer.)
 - Reinstall the new software or new device.

The following directory will help you quickly locate problem categories in the troubleshooting charts.

Problem Type	Go to:
Diskette Drive	Page 86
General	Page 89
Intermittent	Page 90
Keyboard, Mouse, or Pointing-Device	Page 90
Memory	Page 91
Monitor	Page 86
Option	Page 92
Parallel Port	Page 93
Printer	Page 94
Serial Port	Page 93
Software	Page 94

Diskette Drive Problems	Action
Diskette drive in-use light stays on, or the system bypasses the diskette drive.	<p>If there is a diskette in the drive, verify that:</p> <ol style="list-style-type: none"> 1. The diskette drive is enabled. Use the Configuration/Setup Utility program to check the setting. For instructions, refer to "Using the Configuration/Setup Utility Program" on page 33. 2. The computer is checking for the diskette drive in the startup sequence. Use the Configuration/Setup Utility program to verify this. 3. The diskette you are using is good and not damaged. Try inserting another diskette if you have one. 4. The diskette is inserted correctly, with its label up and its metal-shutter end first in the drive. 5. The diskette contains the necessary files to start the computer (the diskette must be startable). 6. The diskette drive cable is properly installed and securely connected. 7. There is no problem with your software program (see Software Problem on page 94). <p>If the problem cannot be isolated and corrected, have the computer serviced.</p>

Monitor Problems	Action
General monitor problems.	<p>Some IBM monitors have their own self-tests. If you suspect a problem with your monitor, refer to the information supplied with the monitor for adjustment and testing instructions.</p> <p>If you cannot find the problem, check the other listings on monitor problems in this table.</p> <p>If the problem cannot be isolated and corrected, have the monitor and computer serviced.</p>

Monitor Problems	Action
Wavy, unreadable, rolling, distorted, or jittery screen images.	<p data-bbox="542 600 1273 653">If the monitor self-tests show that the monitor is working properly, verify that:</p> <ol data-bbox="553 674 1273 1304" style="list-style-type: none"> <li data-bbox="553 674 1273 789">1. The location of the monitor is appropriate. Magnetic fields around other devices, such as transformers, appliances, fluorescent lights, and other monitors might be causing the problem. To determine if this is the difficulty: <ol data-bbox="597 810 1273 1062" style="list-style-type: none"> <li data-bbox="597 810 1273 863">a. Turn off the monitor. (Moving a color monitor while it is turned on might cause screen discoloration.) <li data-bbox="597 884 1273 1020">b. Adjust the placement of the monitor and other devices so that they are at least 305 mm (12 in.) apart. Also, when relocating the monitor, be sure it is at least 75 mm (3 in.) from the diskette drives to prevent diskette drive read/write errors. <li data-bbox="597 1041 857 1062">c. Turn on the monitor. <li data-bbox="553 1083 1273 1199">2. An IBM monitor signal cable is properly connected to the monitor and computer, and that the cable is installed securely. Non-IBM monitor signal cables might cause unpredictable problems. <li data-bbox="553 1220 1273 1304">3. You are not trying to run your monitor at a higher refresh rate than the monitor supports. Refer to the documentation that comes with your monitor for supported refresh rates. <p data-bbox="542 1325 1273 1409">Note: An enhanced monitor signal cable with additional shielding might be available for your monitor. See your IBM reseller or IBM marketing representative for information.</p> <p data-bbox="542 1430 1273 1484">If the problem cannot be isolated and corrected, have the monitor and computer serviced.</p>

Monitor Problems	Action
Screen flickers.	<p>Set the monitor for the highest, noninterlaced refresh rate supported by the monitor and the video controller in your computer. Refer to the documentation that comes with your monitor and the Matrox README file that is provided on the <i>Ready-to-Configure CD</i> that comes with your computer for information on the refresh rates supported by your monitor and the video controller in your computer. (There are several Matrox README files on the CD; use the one that corresponds to your operating system. When you open the appropriate README file, a prompt might appear requesting you to specify Mystique or Millennium. Specify Mystique.)</p> <p>Attention: Using a resolution or refresh rate that is not supported by your monitor might damage it.</p> <p>You can reset the refresh rate through your operating system. Instructions for doing this are included in the Matrox README file that corresponds to your operating system, which is provided on the <i>Ready-to-Configure CD</i>. Refer to your operating-system documentation for further information on monitor settings.</p> <p>If this does not correct the problem, have the monitor and computer serviced.</p>
The monitor works when you turn on the system, but goes blank when you start some application programs.	<p>Verify that:</p> <ol style="list-style-type: none"> 1. The monitor signal cable is securely connected to the monitor and the monitor connector on the computer. For the location of the monitor connector, see “Connectivity” on page 10. 2. The necessary device drivers for the application programs are installed. <p>If the problem cannot be isolated and corrected, have the monitor and computer serviced.</p>
The monitor works when you turn on the system, but goes blank after some period of computer inactivity.	<p>The computer is probably set for energy savings with the Advanced Power Management (APM) feature. If the APM feature is enabled, disabling APM or changing APM settings might solve the problem (see “Advanced Power Management” on page 49).</p> <p>If the problem cannot be isolated and corrected, have the computer serviced.</p>

Monitor Problems	Action
Blank screen.	<p>Verify that:</p> <ol style="list-style-type: none"> 1. The computer power cord is plugged into the computer and a working electrical outlet. 2. The monitor is turned on and the Brightness and Contrast controls are adjusted correctly. 3. The monitor signal cable is securely connected to the monitor and the monitor connector on the computer. For the location of the monitor connector, see “Connectivity” on page 10. <p>If the problem cannot be isolated and corrected, have the monitor and computer serviced.</p>
Only the cursor appears.	Have the computer serviced.
Wrong characters appear on the screen.	Have the computer serviced.
General Problems	Action
The computer does not start when you press the power switch.	<p>Verify that:</p> <ol style="list-style-type: none"> 1. The computer power cord is plugged into the computer and a working electrical outlet. 2. All cables are securely connected to the proper connectors on the computer. For the location of the connectors, refer to “Connectivity” on page 10. 3. The voltage-selection switch is set to the correct position. <p>If the problem cannot be isolated and corrected, have the computer serviced.</p>
Problems such as a broken cover lock or indicator lights not working.	Have the computer serviced.

Intermittent Problems	Action
A problem occurs only occasionally and is difficult to detect.	<p>Verify that:</p> <ol style="list-style-type: none"> 1. All cables and cords are securely connected to the rear of the computer and attached devices. 2. When the computer is turned on, the fan grill is not blocked (there is air flow around the grill), and the fans are working. If airflow is blocked or the fans are not working, the computer might overheat. 3. If an optional SCSI adapter and SCSI devices are installed, the last external device in each SCSI chain is terminated correctly. (See your SCSI documentation.) <p>If the problem cannot be isolated and corrected, have the computer serviced.</p>

Keyboard, Mouse, or Pointing-Device Problems	Action
All or some keys on the keyboard do not work.	<p>Verify that:</p> <ol style="list-style-type: none"> 1. The computer and the monitor are turned on. 2. The keyboard cable is securely connected to the keyboard connector on the computer. For the location of the keyboard connector, see "Connectivity" on page 10. <p>If the problem cannot be isolated and corrected, have the keyboard and computer serviced.</p>

The mouse or pointing device does not work.	<p>Verify that:</p> <ol style="list-style-type: none"> 1. The mouse or pointing-device cable is securely attached to the proper connector on the computer. Depending on the type of mouse you have, it will connect to either the mouse or serial connector. To find the mouse and serial connectors, see "Connectivity" on page 10. 2. The device drivers for the mouse are installed correctly. <p>If the problem cannot be isolated and corrected, have the computer and the device serviced.</p>
---	--

Memory Problems	Action
The amount of memory displayed is less than the amount of memory installed.	<p>The amount of available memory shown might be somewhat less than expected because of basic input/output system (BIOS) shadowing in random access memory (RAM).</p> <p>Verify that:</p> <ol style="list-style-type: none"> 1. You have installed the correct type of DIMMs for your computer. Refer to <i>Installing Options in Your Personal Computer</i> for instructions on adding DIMMs. 2. The DIMMs are properly installed and securely connected. 3. If you added or removed memory, you saved the new configuration in the Configuration/Setup Utility program. See the Important text box on page 34 for instructions on saving the configuration. <p>If the problem persists, run the memory test from the diagnostic program that comes with your computer. (See “Diagnostic Programs” on page 95 for further information.) The system might have detected a bad DIMM and automatically reallocated memory to enable you to continue to operate.</p> <p>If the problem cannot be isolated and corrected, have the computer serviced.</p>
Not enough memory message is displayed.	<p>Verify that terminate-and-stay-resident programs (TSRs) are not taking up memory. (See “Managing TSR Programs (DOS or Microsoft Windows 3.1x)” on page 96.)</p>

Option Problems	Action
An IBM option that was just installed does not work.	<p>Verify that:</p> <ol style="list-style-type: none"> 1. The option is designed for your computer. 2. You followed the installation instructions supplied with the option and in <i>Installing Options in Your Personal Computer</i>. 3. All option files (if required) are installed correctly. See "Installing Files from Option Diskettes" on page 96 for information about installing option files. 4. You have not loosened any other installed options or cables. 5. If the option is an adapter, you have provided enough hardware resources for the adapter to function correctly. Refer to the documentation that comes with the adapter (as well as the documentation for any other installed adapters) to determine the resources required for each adapter. 6. You updated the configuration information in the Configuration/Setup Utility program, if necessary, and have no conflicts. For instructions, refer to "Using the Configuration/Setup Utility Program" on page 33. <p>If the problem persists, run the diagnostic programs. (See "Diagnostic Programs" on page 95 for information about diagnostic programs provided with your computer.)</p> <p>If the problem cannot be isolated and corrected, have the computer and the option serviced.</p>
An IBM option that previously worked does not work now.	<p>Verify that all of the option hardware and cable connections are secure.</p> <p>If the option comes with its own test instructions, use those instructions to test the option.</p> <p>If the failing option is a SCSI option, verify that:</p> <ol style="list-style-type: none"> 1. The cables for all external SCSI options are connected correctly. 2. The last option in each SCSI chain, or the end of the SCSI cable, is terminated correctly. 3. All external SCSI options are turned on. External SCSI options must be turned on before the system is turned on. <p>For more information, see your SCSI documentation.</p> <p>If the problem cannot be isolated and corrected, have the computer and option serviced.</p>

Parallel Port Problems	Action
Parallel port cannot be accessed.	<p>Verify that:</p> <ol style="list-style-type: none"> 1. Each port is assigned a unique address (not set to Disabled). Use the Configuration/Setup Utility program to check the setting. For instructions, refer to "Using the Configuration/Setup Utility Program" on page 33. 2. The parallel-port adapter, if you added one, is properly installed and firmly seated. Refer to <i>Installing Options in Your Personal Computer</i> for instructions on adding adapters. <p>If the problem cannot be isolated and corrected, have the computer serviced.</p>

Serial Port Problems	Action
Serial port cannot be accessed.	<p>Verify that:</p> <ol style="list-style-type: none"> 1. Each port is assigned a unique address (not set to Disabled). Use the Configuration/Setup Utility program to check the setting. For instructions, refer to "Using the Configuration/Setup Utility Program" on page 33. 2. The serial-port adapter, if you added one, is properly installed and firmly seated. Refer to <i>Installing Options in Your Personal Computer</i> for instructions on adding adapters. <p>If the problem cannot be isolated and corrected, have the computer serviced.</p>

Printer Problems	Action
The printer does not work.	<p>Verify that:</p> <ol style="list-style-type: none"> 1. The printer is turned on and is online. 2. The printer signal cable is securely connected to the correct parallel, serial, or USB port on the computer. (Refer to "Connectivity" on page 10 for the location of the parallel, serial, and USB ports.) <p>Note: Non-IBM printer signal cables might cause unpredictable problems.</p> <ol style="list-style-type: none"> 3. You have assigned the printer port correctly in your operating system or application program. 4. You have assigned the printer port correctly in the Configuration/Setup Utility program. (For instructions on using the Configuration/Setup Utility program, refer to "Using the Configuration/Setup Utility Program" on page 33.) 5. If the problem persists, run the tests described in the documentation that comes with your printer. <p>If the problem cannot be isolated and corrected, have the computer and printer serviced.</p>

Software Problem	Action
Is your software program OK?	<p>To determine if problems are caused by installed software, verify that:</p> <ol style="list-style-type: none"> 1. Your computer has the minimum memory requirements needed to use the software. Refer to the information supplied with the software to verify memory requirements. <p>Note: If you have just installed an adapter or memory, you might have a memory address conflict.</p> <ol style="list-style-type: none"> 2. The software is designed to operate on your computer. 3. Other software works on your computer. 4. The software you are using works on another computer. <p>If you received any error messages while using the software program, refer to the information supplied with the software for a description of the messages and solutions to the problem.</p> <p>If the problem cannot be isolated and corrected, have the computer serviced.</p>

Diagnostic Programs

IBM provides programs that you can run to diagnose hardware and some software problems. A description of these programs follows.

QAPLus/PRO: You can use QAPLus/PRO to diagnose hardware problems. QAPLus/PRO also includes several utility programs that provide helpful information about your computer.

For testing purposes, QAPLus/PRO isolates your computer hardware from any software that was preinstalled (or that you have installed) on your hard disk. The program runs independent of the operating system, and *must be run from diskette*. This method of testing is generally used when other methods are not accessible or have not been successful in isolating a problem suspected to be hardware related.

A startable QAPLus/PRO diskette is provided with your computer. For backup purposes, the QAPLus/PRO program is also provided on the *Ready-to-Configure CD* that comes with your computer. To create a startable QAPLus/PRO diskette using the Diskette Factory on the *Ready-to-Configure CD*, refer to *Your Ready-to-Configure CD* for information and instructions on starting the CD. Once you start the CD, follow the instructions on the screen.

To start QAPLus/PRO, do the following:

1. Turn off your computer and any attached devices.
2. Insert the QAPLus/PRO diskette into diskette drive A.
3. Turn on all attached devices; then turn on your computer.
4. Follow the instructions on the screen.

Other QAPLus Diagnostic Programs: The *Ready-to-Configure CD* that comes with your computer also contains diagnostic programs designed specifically for certain operating environments (QAPLus/WIN-WIN for Windows 3.1 and Windows 95). Because these versions of QAPLus work with the operating system, they not only test the hardware, but also analyze certain software components of your computer. They are especially useful in isolating problems related to the operating system and device drivers. Although the hardware diagnostic capabilities of these QAPLus programs are not quite as strong as those of QAPLus/PRO, they are still a good tool for isolating hardware problems.

CoSession Remote: CoSession Remote is a remote-control diagnostic program that can be used by another individual, such as an IBM technical support representative or your in-house administrator, to help diagnose from a remote location, problems with your computer. CoSession is provided on the *Ready-to-Configure CD* that comes with your computer. To use CoSession, it must be installed in your computer.

Important

Before attempting to use CoSession, contact IBM or your in-house administrator for specific instructions on setting up and using the program.

Installing Files from Option Diskettes

An optional device or adapter might come with a diskette. Diskettes that are included in option packages usually contain files that the system needs for recognizing and activating the options. Until you install the necessary files, the new device or adapter might cause error messages.

If your optional device or adapter comes with a diskette, you might need to install some configuration (.CFG) files or diagnostic files (.EXE or .COM) from the diskette to your hard disk. Refer to the documentation that comes with the option to see if you need to install files.

Managing TSR Programs (DOS or Microsoft Windows 3.1x)

Terminate-and-stay-resident programs (TSRs) are loaded into memory and stay there so you can access them whenever you want. If you are loading or using an application program and receive a message that you do not have enough memory, TSR programs might be taking up valuable space.

Check the documentation that comes with each TSR program to find out how to solve this problem. You might be able to remove the program from memory for the rest of your current work session. Sometimes you can change the order in which the TSRs are loaded so that memory is used more efficiently. Or perhaps you can remove from the AUTOEXEC.BAT file the TSR programs that you do not use frequently.

See your operating-system documentation for assistance on editing or disabling statements in the AUTOEXEC.BAT file.

Error Messages Specific to the Integrated Ethernet

Note: The error messages shown in this section are specific to the integrated Ethernet subsystem. These error messages are not available when RPL (remote program load) or DHCP (dynamic host configuration protocol) is used through optional network adapters.

An error message appears on the screen after the Ethernet controller is initialized and a failure condition occurs. These error messages are shown below. If you experience any error related to the integrated Ethernet subsystem, record the error message, and notify your network administrator of the problem.

RPL-Related Error Messages

These error messages are specific to the integrated Ethernet controller and the RPL environment of your computer.

The two most common error messages are shown below.

RPL-ROM-ERR: 105 The Integrated Ethernet Failed the Loopback Test
RPL-ROM-ERR: 107 Media Test Failed; Check the Cable

Error 105 indicates that a power-on diagnostic test performed by the Ethernet chip did not execute correctly. If this error message appears, you must have the computer serviced. Error 107 indicates that the cable from the LAN is not securely connected to the Ethernet port on your computer. Check the cable to ensure that it is properly connected.

Other error messages that might occur are shown in the following table.

RPL-ROM-ERR: 101	Integrated Ethernet was unable to initialize
RPL-ROM-ERR: 102	Integrated Ethernet could not be reset
RPL-ROM-ERR: 100	The integrated Ethernet cannot be found
RPL-ROM-ERR: 103	There are multiple Ethernets in the system. Please specify the correct serial number in NET.CFG.
RPL-ROM-ERR: 104	The integrated Ethernet EEPROM is faulty or not present
RPL-ROM-ERR: 106	The integrated Ethernet is configured for PnP on non-PnP system
RPL-ROM-ERR: 110	Integrated Ethernet RAM failed the memory test

DHCP-Related Error Messages

Error messages related to DHCP and the integrated Ethernet controller are shown in the following table. Each error message consists of an error code followed by a text message.

If you encounter one of these error messages, record the message, and contact your network administrator.

E61: Service boot cancelled.	M38: Cannot open TFTP connection.
E62: Cannot initialize controller.	M39: Cannot read from TFTP connection.
E63: Cannot initialize controller.	M40: BOOTP cancelled by keystroke.
E67: Cannot initialize controller.	M40: DHCP cancelled by keystroke.
E6d: Cannot find BOOTP server.	M41: BOOTP timeout.
E6e: Cannot start from downloaded image.	M41: DHCP timeout.
E71: Too many MTFPT packages.	M42: No client or server IP.
M10: ARP cancelled by keystroke.	M43: No bootfile name.
M11: ARP timeout.	M44: Cannot ARP redirected BOOTP server.
M20: Cannot copy memory.	M6f: System is locked! Press Ctrl+Alt+Del to reboot.
M21: Cannot write to memory.	M90: Cannot initialize controller for multicast.
M22: Cannot write to memory.	M91: MTFPT cancelled by keystroke.
M30: Cannot ARP TFTP address.	M92: MTFPT open timeout.
M31: TFTP cancelled by keystroke.	M93: Unknown MTFPT opcode.
M32: TFTP open timeout.	M94: MTFPT read cancelled by keystroke.
M33: Unknown TFTP opcode.	M95: MTFPT timeout.
M34: TFTP read cancelled by keystroke.	M96: Cannot ARP MTFPT address.
M35: TFTP timeout.	M98: Cannot open MTFPT connection.
M99: Cannot read from MTFPT connection.	Txx: <message from TFTP error packet>

Note: Any x value that follows an error code represents any alphanumeric character.

Chapter 7. Getting Help, Service, and Information

If you need help, service, technical assistance, or just want more information about IBM products, you will find a wide variety of sources available from IBM to assist you.

For example, IBM maintains pages on the World Wide Web where you can get information about IBM products and services, find the latest technical information, and download device drivers and updates. Some of these pages are:

http://www.ibm.com	Main IBM home page
http://www.pc.ibm.com	IBM Personal Computer home page
http://www.us.pc.ibm.com/desktop/	IBM Commercial Desktop home page (U.S.)
http://www.us.pc.ibm.com/servers/	IBM PC Server and Netfinity Server home page (U.S.)
http://www.us.pc.ibm.com/options/	IBM Options home page (U.S.)

You can select a country-specific Web site from these pages.

Help is also available from bulletin boards and online services, as well as by fax and telephone. This section provides information about these sources.

Services available and telephone numbers listed are subject to change without notice.

Before You Call for Service

Many computer problems can be solved without outside assistance, by using the online help or by looking in the online or printed documentation that comes with your computer or software. Also, be sure to read the information in any README files that come with your software.

Most computers, operating systems, and application programs come with documentation that contains troubleshooting procedures and explanations of error messages. The documentation that comes with your computer also contains information about the diagnostic tests you can perform.

If you receive a POST error code when you turn on your computer, refer to the POST error-message charts in your hardware documentation. If you do not receive a POST error code, but suspect a hardware problem, refer to the troubleshooting information in your hardware documentation or run the diagnostic tests.

If you suspect a software problem, consult the documentation (including README files) for the operating system or application program.

Getting Customer Support and Service

Purchasing an IBM PC hardware product entitles you to standard help and support during the warranty period. If you need additional support and services, a wide variety of extended services are available for purchase that address almost any need.

Using Electronic Support Services

If you have a modem, you can get help from several popular services. Bulletin boards and online information services provide assistance through question-and-answer message areas, live chat rooms, searchable databases, and more.

Technical information is available on a wide range of topics, such as:

- Hardware setup and configuration
- Preinstalled software
- OS/2, DOS, and Windows
- Networking
- Communications
- Multimedia

In addition, the latest device driver updates are available.

The IBM PC Company Bulletin Board System (BBS) can be reached 24 hours a day, 7 days a week. Modem speeds of up to 14 400 baud are supported. Long distance telephone charges might apply. To access the PC Company BBS:

- In the U.S., call 1-919-517-0001.
- In Canada:
 - In Halifax, call 902-420-0300.
 - In Montreal, call 514-938-3022.
 - In Toronto, call 905-316-4255 or 416-956-7877.
 - In Vancouver, call 604-664-6461 or 604-664-6464.
 - In Winnipeg, call 204-934-2735.

Commercial online services that contain information about IBM products include:

- CompuServe

Use the following GO words: APTIVA, IBMPS2, ThinkPad, PowerPC, ValuePoint, IBMSVR, or IBMObI.

- **PRODIGY**

Use the Jump command; type **IBM** and select **PC Product Support**.

- **America Online**

Use the “Go to” keyword **IBM Connect**.

Using the World Wide Web

On the World Wide Web, the IBM Personal Computers home page has information about IBM Personal Computer products and support. The address for the IBM Personal Computer home page is:

<http://www.pc.ibm.com>

For information about specific Personal Computer products, visit the following pages:

<http://www.us.pc.ibm.com/intellistation/world/>

<http://www.us.pc.ibm.com/desktop/>

<http://www.us.pc.ibm.com/servers/>

<http://www.us.pc.ibm.com/thinkpad/>

<http://www.us.pc.ibm.com/options/>

You can select a country-specific Web site from these pages.

Getting Information by Fax

If you have a touch-tone telephone and access to a fax machine, in the U.S. and Canada you can receive by fax free marketing and technical information on many topics, including hardware, operating systems, and local area networks (LANs). You can call the IBM PC Company Automated Fax System 24 hours a day, 7 days a week. Follow the recorded instructions, and the requested information will be sent to your fax machine.

To access the IBM PC Company Automated Fax System, do the following:

- In the U.S., call 1-800-426-3395.
- In Canada, call 1-800-465-3299.

Getting Help Online

Online Housecall is a remote communication tool that allows an IBM technical-support representative to access your PC by modem. Many problems can be remotely diagnosed and corrected quickly and easily. In addition to a modem, a remote-access application program is required. This service is not available for servers. There might be a charge for this service, depending on the request.

For more information about configuring your PC for Online Housecall:

- In the U.S., call 1-800-772-2227.
- In Canada, call 1-800-565-3344.
- In all other countries, contact your IBM reseller or IBM marketing representative.

Getting Help by Telephone

During the warranty period, you can get help and information by telephone through the IBM PC Support Line. Expert technical-support representatives are available to assist you with questions you might have on the following:

- Setting up your computer and IBM monitor
- Installing and setting up IBM options purchased from IBM or an IBM reseller
- 30-day, preinstalled-operating-system support
- Arranging for service (on-site or carry-in)
- Arranging for overnight shipment of customer-replaceable parts

In addition, if you purchased an IBM PC Server or IBM Netfinity Server, you are eligible for IBM Start Up Support for 90 days after installation. This service provides assistance for:

- Setting up your network operating system
- Installing and configuring interface cards
- Installing and configuring network adapters

Please have the following information ready when you call:

- Serial numbers of your computer, monitor, and other components, or your proof of purchase
- Description of the problem
- Exact wording of any error messages
- Hardware and software configuration information for your system

If possible, be at your computer when you call.

These services are available 24 hours a day, 7 days a week.⁹

- In the U.S. and Puerto Rico, call 1-800-772-2227.
- In Canada, call 1-800-565-3344.

In all other countries, contact your IBM reseller or IBM marketing representative.

Getting Help Around the World

If you travel with your computer or need to move it to another country, you can register for International Warranty Service. When you register with the International Warranty Service Office, you will receive an International Warranty Service Certificate that is honored virtually worldwide, wherever IBM or IBM resellers sell and service IBM PC products.

For more information or to register for International Warranty Service in the U.S. or Canada, call 1-800-497-7426.

Purchasing Additional Services

During and after the warranty period, you can purchase additional services, such as support for IBM and non-IBM hardware, operating systems, and application programs; network setup and configuration; upgraded or extended hardware repair services; and custom installations. Service availability and name might vary by country.

Enhanced PC Support Line

Enhanced PC Support is available for desktop and mobile IBM computers that are not connected to a network. Technical support is provided for IBM computers and IBM or non-IBM options, operating systems, and application programs on the Supported Products list.

This service includes technical support for:

- Installing and configuring your out-of-warranty IBM computer
- Installing and configuring non-IBM options in IBM computers
- Using IBM operating systems in IBM and non-IBM computers
- Using application programs and games
- Tuning performance
- Installing device drivers remotely

⁹ Response time will vary depending on the number and complexity of incoming calls.

- Setting up and using multimedia devices
- Identifying system problems
- Interpreting documentation

You can purchase this service on a per-call basis, as a multiple-incident package, or as an annual contract with a 10-incident limit. For more information about purchasing Enhanced PC Support, see “Ordering Support Line Services.”

900-Number Operating System and Hardware Support Line

In the U.S., if you prefer to obtain technical support on a pay-as-you go basis, you can use the 900-number support line. The 900-number support line provides support for IBM PC products that are out of the warranty period.

To access this support, call 1-900-555-CLUB (2582). You will be notified of the charge per minute.

Network and Server Support Line

Network and Server Support is available for simple or complex networks made up of IBM servers and workstations using major network operating systems. In addition, many popular non-IBM adapters and network interface cards are supported.

This service includes all of the features of the Enhanced PC Support Line, plus:

- Installing and configuring client workstations and servers
- Identifying system problems and correcting problems on the client or the server
- Using IBM and non-IBM network operating systems
- Interpreting documentation

You can purchase this service on a per-call basis, as a multiple-incident package, or as an annual contract with a 10-incident limit. For more information about purchasing Network and Server Support, see “Ordering Support Line Services.”

Ordering Support Line Services

Enhanced PC Support Line and Network and Server Support Line services are available for products on the Supported Products list. To receive a Supported Products list:

- In the U.S.:
 1. Call 1-800-426-3395.
 2. Select document number 11683 for Network and Server support.
 3. Select document number 11682 for Enhanced PC support.

- In Canada, contact IBM Direct at 1-800-465-7999, or:
 1. Call 1-800-465-3299.
 2. Select the HelpWare catalog.
- In all other countries, contact your IBM reseller or IBM marketing representative.

For more information or to purchase these services:

- In the U.S., call 1-800-772-2227.
- In Canada, call 1-800-465-7999.
- In all other countries, contact your IBM reseller or IBM marketing representative.

Warranty and Repair Services

You can upgrade your standard hardware warranty service or extend the service beyond the warranty period.

Warranty upgrades in the U.S. include:

- Carry-in service to on-site service

If your warranty provides carry-in repair service, you can upgrade to on-site repair service, either standard or premium. The standard upgrade provides a trained servicer within the next business day (9 a.m. to 5 p.m., local time, Monday through Friday). The premium upgrade provides 4-hour average response, 24 hours a day, 7 days a week.

- On-site service to premium on-site service

If your warranty provides for on-site service, you can upgrade to premium on-site service (4-hour average on-site response, 24 hours a day, 7 days a week).

You also can extend your warranty. Warranty and Repair Services offers a variety of post-warranty maintenance options, including ThinkPad EasyServ Maintenance Agreements. Availability of the services varies by product.

For more information about warranty upgrades and extensions:

- In the U.S., call 1-800-426-4968.
- In Canada, call 1-800-465-7999.
- In all other countries, contact your IBM reseller or IBM marketing representative.

Ordering Publications

Additional publications are available for purchase from IBM. For a list of publications available in your country:

- In the U.S., Canada, and Puerto Rico, call 1-800-879-2755.
- In other countries, contact your IBM reseller or IBM marketing representative.

Appendix A. Computer Records

This appendix contains forms for recording information about your computer, which can be helpful if you decide to install additional hardware, or if you ever need to have your computer serviced.

Serial Numbers and Keys

Record and retain the following information.

Product Name	PC 300PL
Model/Type (M/T)	_____
Serial Number (S/N)	_____
Key Serial Number	_____
Key Address	_____

The model and type (M/T) numbers and the serial number (S/N) for your computer are located on a label on the front of the computer, as shown in the illustration that follows.

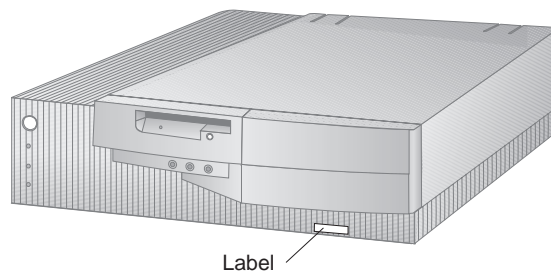

Your computer keys cannot be duplicated by locksmiths. If you lose them, order replacement keys from the key manufacturer. The key serial number and the address of the manufacturer are on a tag attached to the keys. Anyone who has the key serial number and manufacturer's address can order duplicate keys, so store the

tag in a safe place. If you record the key serial number in this book, either remove the page and store it in a secure place, or store this book in a secure place when you are not using it.

Device Records

Use the following tables to keep a record of the options in or attached to your computer. This information can be helpful when you install additional options, or if you ever need to have your computer serviced.

Location	Option Description
System Memory (Mem 0 DIMM)	<input type="checkbox"/> 16 MB <input type="checkbox"/> 32 MB <input type="checkbox"/> 64 MB <input type="checkbox"/> 128 MB
(Mem 1 DIMM)	<input type="checkbox"/> 16 MB <input type="checkbox"/> 32 MB <input type="checkbox"/> 64 MB <input type="checkbox"/> 128 MB
(Mem 2 DIMM)	<input type="checkbox"/> 16 MB <input type="checkbox"/> 32 MB <input type="checkbox"/> 64 MB <input type="checkbox"/> 128 MB
Video Memory	<input type="checkbox"/> 2 MB SGRAM <input type="checkbox"/> 4 MB SGRAM
Expansion Slot 1	_____
Expansion Slot 2	_____
Expansion Slot 3	_____
Expansion Slot 4	_____
Microprocessor	<input type="checkbox"/> Intel Pentium processor <input type="checkbox"/> Intel Pentium processor with MMX technology
Monitor Connector	_____
Mouse Connector	<input type="checkbox"/> 2-button mouse <input type="checkbox"/> Other: _____
Keyboard Connector	104-key keyboard <input type="checkbox"/> Other: _____
Parallel Connector	_____
Serial Connector 1	_____
Serial Connector 2	_____
USB Connector 1	_____
USB Connector 2	_____

Location	Option Description
Audio connectors	_____
Infrared Connector (Optional)	_____
Multimedia Connector (Optional)	_____
3.5-Inch Bay 1	1.44 MB diskette drive
5.25-Inch Bay 2	<input type="checkbox"/> IDE CD-ROM drive (preinstalled in some PC models) <input type="checkbox"/> Other:
5.25-Inch Bay 3	_____
3.5-Inch Bay 4	<input type="checkbox"/> EIDE hard disk drive _____ GB <input type="checkbox"/> SCSI hard disk drive _____ GB <input type="checkbox"/> Other:
_____	_____
_____	_____
_____	_____
_____	_____
_____	_____
_____	_____
_____	_____
_____	_____
_____	_____
_____	_____
_____	_____
_____	_____
_____	_____
_____	_____
_____	_____

Appendix B. Product Warranties, License Information, and Notices

Hardware Limited Warranty

The following is the statement of limited warranty for the United States, Canada, and Puerto Rico.

International Business Machines Corporation

Armonk, New York, 10504

Statement of Limited Warranty

The warranties provided by IBM in this Statement of Limited Warranty apply only to Machines you originally purchase for your use, and not for resale, from IBM or your reseller. The term "Machine" means an IBM machine, its features, conversions, upgrades, elements, or accessories, or any combination of them. Unless IBM specifies otherwise, the following warranties apply only in the country where you acquire the Machine. If you have any questions, contact IBM or your reseller.

Machine: PC 300PL

Warranty Period*: Parts: Three (3) years Labor: One (1) year

IBM will provide warranty service without charge for:

1. parts and labor during the first year of the warranty period
2. parts only, on an exchange basis, in the second and third years of the warranty period.

IBM will charge you for any labor it provides in performance of the repair or replacement.

**Contact your place of purchase for warranty service information.*

Production Status

Each Machine is manufactured from new parts, or new and used parts. In some cases, the Machine may not be new and may have been previously installed.

The IBM Warranty for Machines

IBM warrants that each Machine 1) is free from defects in materials and workmanship and 2) conforms to IBM's Official Published Specifications. The warranty period for a Machine is a specified, fixed period commencing on its Date of Installation. The date on your sales receipt is the Date of Installation, unless IBM or your reseller informs you otherwise.

During the first year of the warranty period IBM or your reseller, if authorized by IBM, will provide warranty service under the type of service designated for the Machine and will manage and install engineering changes that apply to the Machine. During the second and third years, IBM will provide replacement parts in exchange for defective parts.

If a Machine does not function as warranted during the first year of the warranty period, IBM or your reseller will repair it or replace it with one that is at least functionally equivalent, without charge. The replacement may not be new, but will be in good working order. If IBM or your reseller is unable to repair or replace the Machine, you may return it to your place of purchase and your money will be refunded.

For IBM or your reseller to provide warranty service for a feature, conversion, or upgrade, IBM or your reseller may require that the Machine on which it is installed be 1) for certain Machines, the designated, serial-numbered Machine and 2) at an engineering-change level compatible with the feature, conversion, or upgrade. Many of these transactions involve the removal of parts and their return to IBM. You represent that all removed parts are genuine and unaltered. A part that replaces a removed part will assume the warranty service status of the replaced part.

If you transfer a Machine to another user, warranty service is available to that user for the remainder of the warranty period. You should give your proof of purchase and this Statement to that user. However, for Machines which have a life-time warranty, this warranty is not transferable.

Warranty Service

To obtain warranty service or replacement parts for the Machine, you should contact your reseller or call IBM. In the United States, call IBM at **1-800-772-2227**. In Canada, call IBM at **1-800-565-3344**. You may be required to present proof of purchase.

IBM or your reseller will provide certain types of repair and exchange service, either at your location or at a service center, to restore Machines to good working order.

When a type of service involves the exchange of a Machine or part, the item IBM or your reseller replaces becomes its property and the replacement becomes yours. You represent that all removed items are genuine and unaltered. The replacement may not be new, but will be in good working order and at least functionally equivalent to the item replaced. The replacement assumes the warranty service status of the replaced item. Before IBM or your reseller exchanges a Machine or part, you agree to remove all features, parts, options, alterations, and attachments not under warranty service. You also agree to ensure that the Machine is free of any legal obligations or restrictions that prevent its exchange.

You agree to:

1. obtain authorization from the owner to have IBM or your reseller service a Machine that you do not own; and
2. where applicable, before service is provided —
 - a. follow the problem determination, problem analysis, and service request procedures that IBM or your reseller provide,
 - b. secure all programs, data, and funds contained in a Machine, and
 - c. inform IBM or your reseller of changes in a Machine's location.

IBM is responsible for loss of, or damage to, your Machine while it is 1) in IBM's possession or 2) in transit in those cases where IBM is responsible for the transportation charges.

Extent of Warranty

IBM does not warrant uninterrupted or error-free operation of a Machine.

Non-IBM machines are provided by IBM "AS IS" WITHOUT WARRANTIES OF ANY KIND.

The warranties will be voided by misuse, accident, modification, unsuitable physical or operating environment, improper maintenance by you, removal or alteration of Machine or parts identification labels, or failure caused by a product for which IBM is not responsible.

THESE WARRANTIES REPLACE ALL OTHER WARRANTIES OR CONDITIONS, EXPRESS OR IMPLIED, INCLUDING, BUT NOT LIMITED TO, THE IMPLIED WARRANTIES OR CONDITIONS OF MERCHANTABILITY AND FITNESS FOR A PARTICULAR PURPOSE. THESE WARRANTIES GIVE YOU SPECIFIC LEGAL RIGHTS AND YOU MAY ALSO HAVE OTHER RIGHTS WHICH VARY FROM JURISDICTION TO JURISDICTION. SOME JURISDICTIONS DO NOT ALLOW THE EXCLUSION OR LIMITATION OF EXPRESS OR

IMPLIED WARRANTIES, SO THE ABOVE EXCLUSION OR LIMITATION MAY NOT APPLY TO YOU. IN THAT EVENT, SUCH WARRANTIES ARE LIMITED IN DURATION TO THE WARRANTY PERIOD. NO WARRANTIES APPLY AFTER THAT PERIOD.

Any technical or other support provided for a Machine under warranty, such as assistance via telephone with "how-to" questions and those regarding Machine setup and installation, will be provided "AS IS" WITHOUT WARRANTIES OF ANY KIND.

Neither IBM nor its reseller will be responsible for any of your confidential, proprietary or personal information contained in a Machine, which you return to IBM or its reseller for any reason. You should remove all such information from the Machine prior to its return.

Limitation of Liability

Circumstances may arise where, because of a default on IBM's part or other liability, you are entitled to recover damages from IBM. In each such instance, regardless of the basis on which you are entitled to claim damages from IBM (including fundamental breach, negligence, misrepresentation, or other contract or tort claim), IBM is liable for no more than:

1. damages for bodily injury (including death) and damage to real property and tangible personal property; and
2. the amount of any other actual direct damages, up to the greater of U.S. \$100,000 or the charges (if recurring, 12 months' charges apply) for the Machine that is the subject of the claim.

UNDER NO CIRCUMSTANCES IS IBM LIABLE FOR ANY OF THE FOLLOWING: 1) THIRD-PARTY CLAIMS AGAINST YOU FOR LOSSES OR DAMAGES (OTHER THAN THOSE UNDER THE FIRST ITEM LISTED ABOVE); 2) LOSS OF, OR DAMAGE TO, YOUR RECORDS OR DATA; OR 3) SPECIAL, INCIDENTAL, OR INDIRECT DAMAGES OR FOR ANY ECONOMIC CONSEQUENTIAL DAMAGES (INCLUDING LOST PROFITS OR SAVINGS), EVEN IF IBM OR YOUR RESELLER IS INFORMED OF THEIR POSSIBILITY. SOME JURISDICTIONS DO NOT ALLOW THE EXCLUSION OR LIMITATION OF INCIDENTAL OR CONSEQUENTIAL DAMAGES, SO THE ABOVE EXCLUSION OR LIMITATION MAY NOT APPLY TO YOU.

License Information

The license information in this booklet is for IBM and non-IBM logo programs covered by the IBM International Program License Agreement. IBM may provide programs with this computer which come with their own license agreements. Unless otherwise expressly provided by IBM, IBM provides these programs to you "AS IS" WITHOUT WARRANTIES OF ANY KIND, INCLUDING, BUT NOT LIMITED TO THE IMPLIED WARRANTIES OF MERCHANTABILITY AND FITNESS FOR A PARTICULAR PURPOSE.

Some programs referred to in this booklet might not be available in all languages or in all countries. Some programs might be different from the retail versions and might be customized to work only with the product with which they are shipped. These programs might not include all documentation or functions. Not all programs are sold separately.

Program Name

System Programs

Additional Terms and Conditions

Authorization for Copy and Use on Home/Portable Computer: Not applicable for these programs.

Transfer of Program: Programs are transferable with written consent from the party (IBM or its reseller) from whom you acquired the program.

Proof of Entitlement: The Proof of Purchase for the computer that contains these programs should be retained in order to support eligibility provided by IBM or its authorized reseller for future upgrade program prices (if announced), potential special or promotional opportunities (if any), and as evidence of the end user's authorized use of these IBM-licensed programs.

Technical support for programs provided with your system is available on a limited basis. See the publications provided with your system for details.

Program Services

Availability/Duration of Program Services: No program services are available for these programs.

Statement of Service: No program services are available. These licensed programs are provided "AS IS."

Warranty

System Programs – No.

PROGRAMS DESIGNATED AS "NO" ARE PROVIDED WITHOUT A PROGRAM WARRANTY. THEY ARE PROVIDED "AS IS" WITHOUT WARRANTY OF ANY KIND. IBM DISCLAIMS ALL WARRANTIES FOR THESE PROGRAMS, EITHER EXPRESS OR IMPLIED, INCLUDING BUT NOT LIMITED TO IMPLIED WARRANTIES OF MERCHANTABILITY AND FITNESS FOR A PARTICULAR PURPOSE.

U.S. Government Users Restricted Rights

U.S. Government Users Restricted Rights—Use, duplication, or disclosure restricted by the GSA ADP Schedule Contract with IBM Corporation.

Other Documentation

Any other documentation with respect to its licensed program, including any such documentation referenced herein, is provided for information purposes only and does not extend or modify the material contained in the License information.

Other Additional Terms and Conditions

These additional terms and conditions apply to device drivers, utility programs, and flash BIOS code ("System Programs") shipped with an IBM system ("System") on diskette or CD-ROM, preinstalled on a System, created on diskette from a CD-ROM, System, or Local Area Network (LAN) using a diskette-creation program provided by IBM, or placed on a LAN. A System includes IBM computers, features, conversions, upgrades, and options, either separately or in any combination.

If you are the rightful possessor of a System, or if you have obtained the System Programs for the sole purpose of maintaining a System, IBM or the applicable IBM country organization grants you a license to use the System Programs as part of or in conjunction with a System, or to restore and maintain the System Programs. You can make copies of the System Programs and distribute them to the rightful possessor of a System and install the System Programs for a rightful possessor (but only to the extent necessary to restore or maintain the System), provided that you supply such party a copy of this Agreement. Initial use of the System Programs by such party shall indicate acceptance of this agreement.

**YOU MUST REPRODUCE THE COPYRIGHT NOTICE AND ANY OTHER
LEGEND OF OWNERSHIP ON EACH COPY, OR PARTIAL COPY, OF A
PROGRAM YOU CREATE ON DISKETTE OR OTHER PORTABLE MEDIUM.**

Notices

References in this publication to IBM products, programs, or services do not imply that IBM intends to make these available in all countries in which IBM operates. Any reference to an IBM product, program, or service is not intended to state or imply that only that IBM product, program, or service may be used. Subject to IBM's valid intellectual property or other legally protectable rights, any functionally equivalent product, program, or service may be used instead of the IBM product, program, or service. The evaluation and verification of operation in conjunction with other products, except those expressly designated by IBM, are the responsibility of the user.

IBM may have patents or pending patent applications covering subject matter in this document. The furnishing of this document does not give you any license to these patents. You can send license inquiries, in writing, to:

IBM Director of Licensing
IBM Corporation
500 Columbus Avenue
Thornwood, NY 10594
U.S.A.

Trademarks

The following terms are trademarks of the IBM Corporation in the United States or other countries or both:

Aptiva	IBM
NetFinity	OS/2
PowerPC	PS/2
ThinkPad	ValuePoint
Wake on LAN	

The following terms are trademarks of other companies:

Adaptec	Adaptec, Inc.
Adlib	Adlib Multimedia, Inc.
America Online	America Online, Inc.
CompuServe	CompuServe Incorporated
CoSession Remote	Artisoft, Inc.
DMI	Desktop Management Task Force
Matrox	Matrox Electronic Systems, Ltd.
MGA	Matrox Graphics Inc.
PRODIGY	Prodigy Services Company
QAPLus	DiagSoft, Inc.

QAPLus/PRO
Sound Blaster
Sound Blaster Pro
VESA

Diagsoft, Inc.
Creative Technology Ltd.
Creative Technology Ltd.
Video Electronics Standards Association

Intel, MMX, and Pentium are trademarks or registered trademarks of Intel Corporation.

Microsoft, Windows, and Windows NT are trademarks or registered trademarks of Microsoft Corporation.

Other company, product, and service names may be trademarks or service marks of others.

Electronic Emission Notices

PC 300PL

Federal Communications Commission (FCC) Statement

Note: This equipment has been tested and found to comply with the limits for a Class B digital device, pursuant to Part 15 of the FCC Rules. These limits are designed to provide reasonable protection against harmful interference in a residential installation. This equipment generates, uses, and can radiate radio frequency energy and, if not installed and used in accordance with the instructions, may cause harmful interference to radio communications. However, there is no guarantee that interference will not occur in a particular installation. If this equipment does cause harmful interference to radio or television reception, which can be determined by turning the equipment off and on, the user is encouraged to try to correct the interference by one or more of the following measures:

- Reorient or relocate the receiving antenna.
- Increase the separation between the equipment and receiver.
- Connect the equipment into an outlet on a circuit different from that to which the receiver is connected.
- Consult an IBM authorized dealer or service representative for help.

Properly shielded and grounded cables and connectors must be used in order to meet FCC emission limits. Proper cables and connectors are available from IBM authorized dealers. IBM is not responsible for any radio or television interference caused by using other than recommended cables and connectors or by unauthorized changes or modifications to this equipment. Unauthorized changes or modifications could void the user's authority to operate the equipment.

This device complies with Part 15 of the FCC Rules. Operation is subject to the following two conditions: (1) this device may not cause harmful interference, and (2) this device must accept any interference received, including interference that may cause undesired operation.

Responsible Party:

International Business Machines Corporation
Old Orchard Road
Armonk, NY 10504
Telephone: 1-919-543-2193

Industry Canada Class B Emission Compliance Statement

This Class B digital apparatus meets the requirements of the Canadian Interference-Causing Equipment Regulations.

Avis de conformité à la réglementation d'Industrie Canada

Cet appareil numérique de la classe B respecte toutes les exigences du Règlement sur le matériel brouilleur du Canada.

European Community Directive Conformance Statement

This product is in conformity with the protection requirements of EU Council Directive 89/336/EEC on the approximation of the laws of the Member States relating to electromagnetic compatibility. IBM cannot accept responsibility for any failure to satisfy the protection requirements resulting from a nonrecommended modification of the product, including the fitting of non-IBM option cards.

Telecommunication Notices

Federal Communications Commission (FCC) and Telephone Company Requirements

1. This device complies with Part 68 of the FCC rules. A label is affixed to the device that contains, among other things, the FCC registration number, USOC, and Ringer Equivalency Number (REN) for this equipment. If these numbers are requested, provide this information to your telephone company.

Note: If the device is an internal modem, a second FCC registration label is also provided. You may attach the label to the exterior of the computer in which you install the IBM modem, or you may attach the label to the external DAA, if you have one. Place the label in a location that is easily accessible, should you need to provide the label information to the telephone company.

2. The REN is useful to determine the quantity of devices you may connect to your telephone line and still have those devices ring when your number is called. In most, but not all areas, the sum of the RENs of all devices should not exceed five (5). To be certain of the number of devices you may connect to your line, as determined by the REN, you should call your local telephone company to determine the maximum REN for your calling area.
3. If the device causes harm to the telephone network, the telephone company may discontinue your service temporarily. If possible, they will notify you in advance; if advance notice is not practical, you will be notified as soon as possible. You will be advised of your right to file a complaint with the FCC.
4. Your telephone company may make changes in its facilities, equipment, operations, or procedures that could affect the proper operation of your equipment. If they do, you will be given advance notice to give you an opportunity to maintain uninterrupted service.
5. If you experience trouble with this product, contact your authorized reseller, or call IBM. In the United States, call IBM at **1-800-772-2227**. In Canada, call IBM at **1-800-565-3344**. You may be required to present proof of purchase.

The telephone company may ask you to disconnect the device from the network until the problem has been corrected, or until you are sure the device is not malfunctioning.

6. No customer repairs are possible to the device. If you experience trouble with the device, contact your Authorized Reseller or see the Diagnostics section of this manual for information.
7. This device may not be used on coin service provided by the telephone company. Connection to party lines is subject to state tariffs. Contact your state public utility commission or corporation commission for information.
8. When ordering network interface (NI) service from the local Exchange Carrier, specify service arrangement USOC RJ11C.

Canadian Department of Communications Certification Label

NOTICE: The Canadian Department of Communications label identifies certified equipment. This certification means that the equipment meets certain telecommunications network protective, operational, and safety requirements. The Department does not guarantee the equipment will operate to the user's satisfaction.

Before installing this equipment, users should ensure that it is permissible to be connected to the facilities of the local telecommunications company. The equipment must also be installed using an acceptable method of connection. In some cases, the company's inside wiring associated with a single line individual service may be extended by means of a certified connector assembly (telephone extension cord). The customer should be aware that compliance with the above conditions may not prevent degradation of service in some situations.

Repairs to certified equipment should be made by an authorized Canadian maintenance facility designated by the supplier. Any repairs or alterations made by the user to this equipment, or equipment malfunctions, may give the telecommunications company cause to request the user to disconnect the equipment.

Users should ensure for their own protection that the electrical ground connections of the power utility, telephone lines, and internal metallic water pipe system, if present, are connected together. This precaution may be particularly important in rural areas.

Caution: Users should not attempt to make such connections themselves, but should contact the appropriate electric inspection authority, or electrician, as appropriate.

NOTICE: The LOAD NUMBER (LN) assigned to each terminal device denotes the percentage of the total load to be connected to a telephone loop which is used by the device, to prevent overloading. The termination on a loop may consist of any combination of devices subject only to the requirement that the sum of the LOAD NUMBERS of all the devices does not exceed 100.

Étiquette d'homologation du ministère des Communications du Canada

AVIS : L'étiquette du ministère des Communications du Canada identifie le matériel homologué. Cette étiquette certifie que le matériel est conforme à certaines normes de protection, d'exploitation et de sécurité des réseaux de télécommunications. Le ministère n'assure toutefois pas que le matériel fonctionnera à la satisfaction de l'utilisateur.

Avant d'installer ce matériel, l'utilisateur doit s'assurer qu'il est permis de le raccorder aux installations de l'entreprise locale de télécommunications. Le matériel doit également être installé en suivant une méthode acceptée de raccordement. L'abonné ne doit pas oublier qu'il est possible que la conformité aux conditions énoncées ci-dessus n'empêchent pas la dégradation du service dans certaines situations.

Les réparations de matériel homologué doivent être effectuées par un centre d'entretien canadien autorisé désigné par le fournisseur. La compagnie de télécommunications peut demander à l'utilisateur de débrancher un appareil à la suite de réparations ou de modifications effectuées par l'utilisateur ou à cause d'un mauvais fonctionnement.

Pour sa propre protection, l'utilisateur doit s'assurer que tous les fils de mise à la terre de la source d'énergie électrique, des lignes téléphoniques et des canalisations d'eau métalliques, s'il y en a, sont raccordés ensemble. Cette précaution est particulièrement importante dans les régions rurales.

Avertissement : l'utilisateur ne doit pas tenter de faire ces raccordements lui-même, il doit avoir recours à un service d'inspection des installations électriques ou à un électricien, selon le cas.

AVIS : L'INDICE DE CHARGE (IC) assigné à chaque dispositif terminal indique, pour éviter toute surcharge, le pourcentage de la charge totale qui peut être raccordé à un circuit téléphonique bouclé utilisé par ce dispositif. L'extrémité du circuit bouclé peut consister en n'importe quelle combinaison de dispositifs pourvu que la somme des INDICES DE CHARGE de l'ensemble des dispositifs ne dépasse pas 100.

Power Cord Notice

For your safety, IBM provides a power cord with a grounded attachment plug to use with this IBM product. To avoid electrical shock, always use the power cord and plug with a properly grounded outlet.

IBM power cords used in the United States and Canada are listed by Underwriter's Laboratories (UL) and certified by the Canadian Standards Association (CSA).

For units intended to be operated at 115 volts: Use a UL-listed and CSA-certified cord set consisting of a minimum 18 AWG, Type SVT or SJT, three-conductor cord, a maximum of 15 feet in length and a parallel blade, grounding-type attachment plug rated 15 amperes, 125 volts.

For units intended to be operated at 230 volts (U.S. use): Use a UL-listed and CSA-certified cord set consisting of a minimum 18 AWG, Type SVT or SJT, three-conductor cord, a maximum of 15 feet in length and a tandem blade, grounding-type attachment plug rated 15 amperes, 250 volts.

For units intended to be operated at 230 volts (outside the U.S.): Use a cord set with a grounding-type attachment plug. The cord set should have the appropriate safety approvals for the country in which the equipment will be installed.

IBM power cords for a specific country are usually available only in that country:

IBM Power Cord Part Number	Used in These Countries
13F9940	Argentina, Australia, China (PRC), New Zealand, Papua New Guinea, Paraguay, Uruguay, Western Samoa
13F9979	Afghanistan, Algeria, Andorra, Angola, Austria, Belgium, Benin, Bulgaria, Burkina Faso, Burundi, Cameroon, Central African Rep., Chad, Czech Republic, Egypt, Finland, France, French Guiana, Germany, Greece, Guinea, Hungary, Iceland, Indonesia, Iran, Ivory Coast, Jordan, Lebanon, Luxembourg, Macau, Malagasy, Mali, Martinique, Mauritania, Mauritius, Monaco, Morocco, Mozambique, Netherlands, New Caledonia, Niger, Norway, Poland, Portugal, Romania, Senegal, Slovakia, Spain, Sudan, Sweden, Syria, Togo, Tunisia, Turkey, former USSR, Vietnam, former Yugoslavia, Zaire, Zimbabwe
13F9997	Denmark
14F0015	Bangladesh, Burma, Pakistan, South Africa, Sri Lanka
14F0033	Antigua, Bahrain, Brunei, Channel Islands, Cyprus, Dubai, Fiji, Ghana, Hong Kong, India, Iraq, Ireland, Kenya, Kuwait, Malawi, Malaysia, Malta, Nepal, Nigeria, Polynesia, Qatar, Sierra Leone, Singapore, Tanzania, Uganda, United Kingdom, Yemen, Zambia
14F0051	Liechtenstein, Switzerland
14F0069	Chile, Ethiopia, Italy, Libya, Somalia
14F0087	Israel
1838574	Thailand
62X1045	Bahamas, Barbados, Bermuda, Bolivia, Brazil, Canada, Cayman Islands, Colombia, Costa Rica, Dominican Republic, Ecuador, El Salvador, Guatemala, Guyana, Haiti, Honduras, Jamaica, Japan, Korea (South), Liberia, Mexico, Netherlands Antilles, Nicaragua, Panama, Peru, Philippines, Saudi Arabia, Suriname, Taiwan, Trinidad (West Indies), United States of America, Venezuela

Index

Numerics

- 1-800 telephone assistance 102
- 900 number support 104

A

- adapters 3, 7
- adjusting chair 17
- administrator password
 - computer startup 20, 43
 - Configuration/Setup Utility program 43
 - deleting 46
 - forgotten 46
 - setting 44
 - using 44
- advanced power management 7, 49
- air circulation 18
- alternate boot sequence 54
- America Online 101
- antiglare filter 18
- arranging workspace 17
- asset
 - security features 7
- assistance 99
- audio
 - controller 5, 12
 - features, using 24
- automatic power-on
 - modem ring detect 51
 - serial port ring detect 51
 - startup sequence 54
 - Wake on LAN 51
 - wake up on alarm 51

B

- backing up hard disk drive 59
- basic input/output system, updating 26
- battery
 - disposing of 59

- battery (*continued*)
 - failure message 67
 - notice ix
 - replacing 59
- bays, drive 9, 11
- beeps 20, 63
- BIOS, updating 26
- bulletin boards 100
- bus
 - ISA 2
 - PCI 2

C

- cable lengths 18
- cache memory 11
- care of computer 57
- CD-ROM drive 12
 - adding 9
 - feature 3
 - using 28
- CD, using 29
- chair adjustments 17
- circulation, air 18
- cleaning
 - compact discs 29
 - computer 57
 - monitor 68
 - mouse 58
- client LAN light 19
- comfort 17
- CompuServe 100
- configuration of computer 33
- Configuration/Setup Utility program
 - capabilities 33
 - computer startup 20
 - exiting 37
 - starting 34
 - updating 26
- connectors 10

- controls 19
- cord, power 18
- CoSession Remote 96
- cover
- cover lock, broken 89

D

- damage, preventing 57, 59
- date, setting 39
- DDC (display data channel) 23
- Desktop Management Interface 25
- device configuration error 68
- device drivers, video 23
- DHCP 25
 - defined 53
 - enabling or disabling 53
 - error messages 98
- diagnostic
 - charts 85
 - programs 7, 95
 - tools 61
- DIMMs 11
- diskette drives 11
 - adding 9
 - eject button 19
 - indicator light 19
 - location 9
 - problems, solving 86
 - supported 11
- diskettes
 - ejecting 19
 - option 96
- display
 - See monitor
- display data channel (DDC) 23
- Display Power Management Signaling (DPMS) 50
- DMI 25
- DPMS (Display Power Management Signaling) 50
- drive
 - bays 9, 11
 - CD-ROM 3
 - hard disk 3

- drive (*continued*)
 - problems, solving 86
- drivers, video device 23
- dual in-line memory modules (DIMMs) 11
- dynamic host configuration protocol 25
 - See also DHCP

E

- ECP/EPP 4, 12
- EEPROM 27
- EIDE hard disk drive 3
- electrical outlets 18
- electronic
 - emission notices 119
- electronic support 100
- energy-saving features 49
- enhanced parallel port 4, 12
- ergonomic features 7
- error
 - messages, POST 20, 64
 - symptoms 85
- Ethernet controller 5, 12
- Ethernet support 53
- expansion slots
 - available 9, 13
 - installing adapters in 3
- extended capabilities port 4, 12
- extension cords 18

F

- fan problems 90
- fatigue 17
- fax, getting information by 101
- features, computer 11
- fee services 103
- fixed disk drives
 - See hard disk drives
- flash
 - memory 11
- flash memory 27
- flash, BIOS 26
- flicker, reducing 22

G

glare, reducing 18

H

hard disk drives

- adding 9
- backing up 59
- indicator light 19
- location 9
- maximum 3
- power management 50
- supported 3, 11

hardware power management 50

heat output 15

help 99

home page, IBM Personal Computer 99,
101

I

IDE 3

identification numbers 107

indicators, status 19

infrared port 5, 12

input/output features 12

intermittent problems 90

international warranty service 103

Internet home page 99, 101

ISA

bus 2

expansion slots 13

K

keyboard

locked 40

problems 90

supported 12

using 17

keys 107

L

LAN wake-up requests 51, 54

laser compliance statement viii

lighting 18

lights, indicator 19

lithium battery caution 67

locks 89

M

Matrox MGA-1164SG 3-D video

controller 5, 23

memory

available 63

cache 11

configuration error 69

counting 20

DIMMs 11

flash 11

problems 91

supported 11

video 12

messages, error 63

microprocessor

speed 11

standard 2, 11

upgrading 2

modem

ring detect 51

serial port ring detect 51

monitor

care of 18

DDC standard 23

flicker 22

off mode 50

placement of 18

power management 49, 50

problems, solving 86

refresh rate 22

resolution 22

settings 22

standby mode 50

suspend mode 50

mouse
 cleaning 58
 locked 40
 password prompt off mode 42
 port 21, 42
 problems 90
 serial port 21, 42
 unattended start mode 42
 using 21
moving computer 59

N

network
 management 25
 updating POST/BIOS from 25
network and server startup support 102
network and server support services,
 fee 104
noise level 16
notices 111

O

office space, arranging 17
Online Housecall 102
online information services 100
operating systems
 supported 6, 14
option
 diskettes 96
 installed 109
 problems 92
options, video 23
ordering support line services 104

P

parallel port
 available 12
 ECP/EPP 4
 problems 93
 SPP 4
passwords
 administrator 44

passwords (*continued*)
 computer startup 20, 43
 Configuration/Setup Utility
 program 45
 power-on 40
 using 40
PC support services, fee 103
PCI
 bus 2
 expansion slots 13
peripheral component interconnect
 See PCI
planning workspace 17
Plug and Play control features,
 changing 39
Plug and Play technology 6, 13
pointing device problems 90
ports 10
POST
 at startup 20
 description of 62
 error messages 64
 message charts 67
 updating 26
POST/BIOS, remote update 55
POST/BIOS, update from network 25
power
 cord 18, 123
 indicator light 19
 management 49
 output 13
 switch 19
power management
 See advanced power management
power-on password
 computer startup 20, 43
 deleting 44
 forgotten 44
 setting 40
 unattended start mode 40
 using 40
power-on self-test
 See POST

printer problems 94
privileged-access password
 See administrator password
problems
 solving 61
 startup 20
processor
 See microprocessor
PRODIGY 101
publications, ordering 106

Q

QAPLus 95
QAPLus/PRO 95

R

records, device and feature 109
refresh rate 22
remote program load 25
 See also RPL
remote technical support 102
resolution 22
riser card 3, 13
RPL 25
 defined 53
 enabling or disabling 53
 error messages 97

S

safety, electrical vii
screen filter 18
SCSI hard disk drive 3
security
 features 7, 13
 passwords 40
serial numbers 107
serial ports
 16550-UART 4
 available 12
 problems 93
 ring detect 51

server startup support 102
server support 102
service and support 8
services, fee 103
setup of computer 33
Setup Utility
 See Configuration/Setup Utility program
shutting down computer 22
slots, expansion 9
software
 errors 94
 preinstalled 6, 14
 problems 94
solving problems 61, 99
specifications 15
SPP 4
standard parallel port 4
starting computer 20
startup sequence
 automatic power on 51, 54
status indicators 19
summary, system 38
super video graphics array (SVGA) 22
support line services, ordering 104
surge protectors 18
SVGA (super video graphics array) 22
system
 specifications 15
 summary 38
system management
 controller 25
 features 6
 settings 52
 using 25

T

technical support
technical support, fee 103
technical support, remote 102
technical support, warranty 102
telecommunication notices 121
telephone assistance 102
terminate-and-stay resident programs
 (TSRs) 96

- time, setting 39
- trademarks 117
- troubleshooting
 - charts 85
 - information 61
- TSR programs 96
- turning
 - off computer 22
 - on computer 20

U

- unattended start mode 40
- universal serial bus ports 4, 12
- update POST/BIOS from network 55

V

- venting of hot air 18
- VGA (video graphics array) 22
- video
 - controller 12, 23
 - device drivers, installing 23
 - features 22
 - modes 22
 - options, installing 23
 - port 12
 - SVGA 22
 - VGA 22
- video controller 5

W

- Wake on LAN 25, 51, 54
- wake up on alarm 51
- warranty
 - copy of 111
- warranty extensions and upgrades 105
- warranty service 102
- work area, arranging 17
- World Wide Web home page 99, 101



Part Number: 06J0871

Printed in U.S.A.

July 1997

06J0871

