

451-009700300

EXP8551

TABLE OF CONTENTS

CHAPTER 1 INTRODUCTION	1
1.1 OVERVIEW.....	1
1.2 SYSTEM FEATURES	1
1.3 SYSTEM SPECIFICATION.....	2
1.4 SYSTEM PERFORMANCE.....	2
1.5 EXP8551 BOARD LAYOUT	3
CHAPTER 2 INSTALLATION	4
2.1 DRAM INSTALLATION	4
2.2 SRAM INSTALLATION	6
2.3 CPU INSTALLATION	7
2.4 CPU TYPE REFERENCY SETTING	9
2.5 IDE SELECT	10
2.6 FLASH ROM INSTALLATION.....	11
2.7 EPP MODE SETTING.....	12
2.8 OTHER JUMPER & CONNECTOR INSTALLATION	13
CHAPTER 3 SYSTEM BIOS SETUP.....	16
3.1 SYSTEM SETUP.....	18
3.2 SECURITY SETUP	24
3.3 DEFAULT SETUP	27

RMA FORM

CHAPTER 1

INTRODUCTION

1.1 OVERVIEW

The *EXP8551* is complemented by a 512K second-level Write-Back cache providing workstation level computing performance, and SIMM sockets support up to 128MB of DRAM.

The *EXP8551* motherboard offers outstanding I/O capabilities. Four PCI Local Bus slots provide a high bandwidth data path for data-movement intensive function such as Graphics. Four ISA slots complete the I/O mix.

The *EXP8551* motherboard provides the foundation for cost effective, high performance, highly expandable platforms which deliver the latest *EXP8551* in CPU and I/O technologies.

1.2 SYSTEM FEATURES

- Supports INTEL PENTIUM 75/90/100/120/133/150/166/200 MHZ CPU,
CYRIX 6x86-120⁺(100MHZ)/6x86-150⁺(120MHZ)/6x86-166⁺(133MHZ) CPU,
AMD 5_k86-P75/5_k86-P90 CPU
- Supports 4 MASTER 32-bit PCI Bus
- Supports L1/L2 Write Back/Write Through Cache Feature
- Supports 256KB/512KB Cache Size
- Supports 72pin SIM MODULES
- Supports 2 Serial 1 Parallel 1 FDC on board
- Supports 2 Channels PCI IDE on board

1.3 SYSTEM SPECIFICATIONS

Processor: INTEL PENTIUM
75/90/100/120/133/150/166/200 MHZ CPU
CYRIX 6x86-120⁺(100MHZ)/6x86-
150⁺(120MHZ)/
6x86-166⁺(133MHZ) CPU
AMD 5_k86-P75/5_k86-P90 CPU
CPU Clock: 50/60/66 MHZ CPU
Memory: 2MB to 128MB
SRAM Configuration: 256K/512K
BIOS Subsystem: AMI BIOS
Additional BIOS Feature: Set Program Resides in ROM
I/O Subsystem No. Slot: Four 16-bit ISA Bus
Four PCI 32-bit Bus
Dimension: 29x22 cm

Additional Features

Miscellaneous Connectors: Reset Button, Internal Battery
Board Design: 4-layer Implementation for Low Noise Operation

1.4 SYSTEM PERFORMANCE

SOFTWARE CPU TYPE	LANDMARK V2.0	POWER METER V1.8 MIPS	NORTON V8.0 CPU SPEED
PENTIUM 75	432.86 MHZ	36.5 MIPS	237.7
PENTIUM 90	519.45 MHZ	44.4 MIPS	285.2
PENTIUM 100	574.55 MHZ	49.0 MIPS	315.4
PENTIUM 120	692.62 MHZ	58.0 MIPS	380.2
PENTIUM 133	766.1 MHZ	64.6 MIPS	420.6
PENTIUM 150	865.85 MHZ	69.4 MIPS	475.4
PENTIUM 166	957.65 MHZ	81.3 MIPS	525.8
CYRIX 6x86-120 ⁺ (100MHZ)	1209.93 MHZ	66.1 MIPS	680.2
CYRIX 6x86-150 ⁺	1448.60 MHZ	81.3 MIPS	813.9

(120MHZ)			
CYRIX 6x86-166+ (133MHZ)	1602.13 MHZ	88.9 MIPS	900.7
AMD 5x86-P75	671.71 MHZ	38.4 MIPS	297
AMD 5x86-P90	806.09 MHZ	47.4 MIPS	356.5

1.5 EXP8551 BOARD LAYOUT

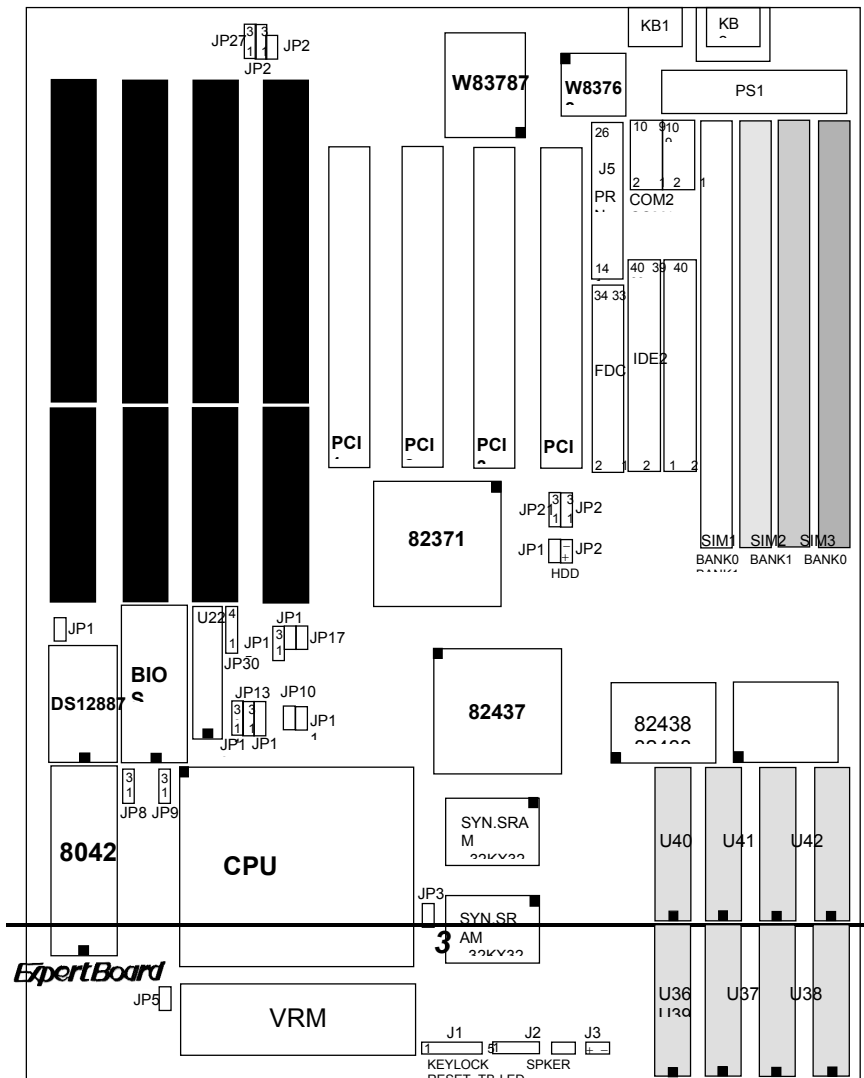

CHAPTER 2 INSTALLATION

Before the system is ready to operate, the hardware must be set up for various functions of the system. To set up the EXP8551 motherboard is a simple task. The user only has to set a few jumpers, connectors and sockets.

2.1 DRAM INSTALLATION

The EXP8551 motherboard can support expanded memory from 2MB to 128MB.

■ The board layout below shows the locations of the DRAM memory banks:

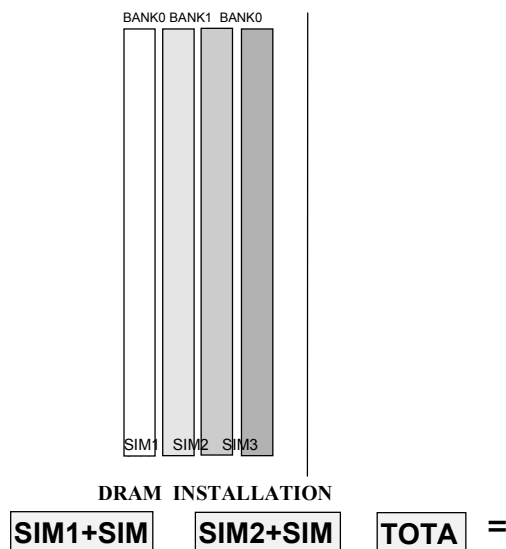

EXP8551 User's Manual

Each group includes two SIMs each SIM size can be 1, 2, 4, 8, 16, 32MB, please install the same DRAM size in one group.

■ **TABLE (SIMM)**

BANK 0		BANK 1		TOTAL MEMORY
SIMM1	SIMM3	SIMM2	SIMM4	
4MB	4MB	None	None	8MB
4MB	4MB	4MB	4MB	16MB
8MB	8MB	None	None	16MB
4MB	4MB	8MB	8MB	24MB
8MB	8MB	4MB	4MB	24MB
8MB	8MB	8MB	8MB	32MB
16MB	16MB	None	None	32MB
4MB	4MB	16MB	16MB	40MB
16MB	16MB	4MB	4MB	40MB
8MB	8MB	16MB	16MB	48MB
16MB	16MB	8MB	8MB	48MB
16MB	16MB	16MB	16MB	64MB
32MB	32MB	None	None	64MB
4MB	4MB	32MB	32MB	72MB
32MB	32MB	4MB	4MB	72MB
8MB	8MB	32MB	32MB	80MB
32MB	32MB	8MB	8MB	80MB
16MB	16MB	32MB	32MB	96MB
32MB	32MB	16MB	16MB	96MB
32MB	32MB	32MB	32MB	128MB

2.2 SRAM INSTALLATION

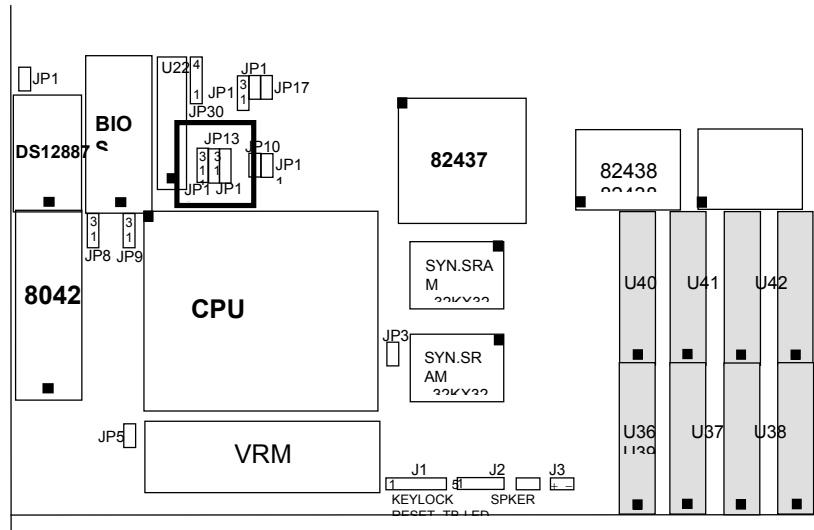

CACHE SIZE CONFIGURATION

256K		512K	
TAG RAM	DATA RAM	TAG RAM	DATA RAM
U22 8KX8, 16KX8, 32KX8	U36-U43 32KX8	U22 16KX8, 32KX8	U36-U43 64KX8

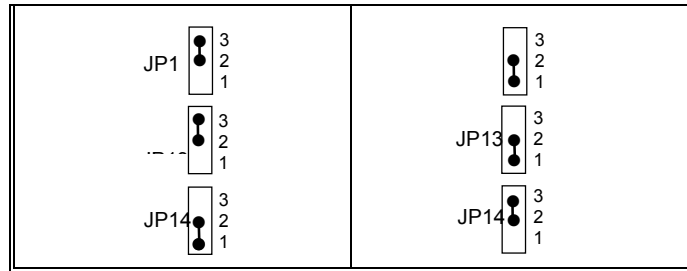

♣ Default setting

2.3 CPU INSTALLATION

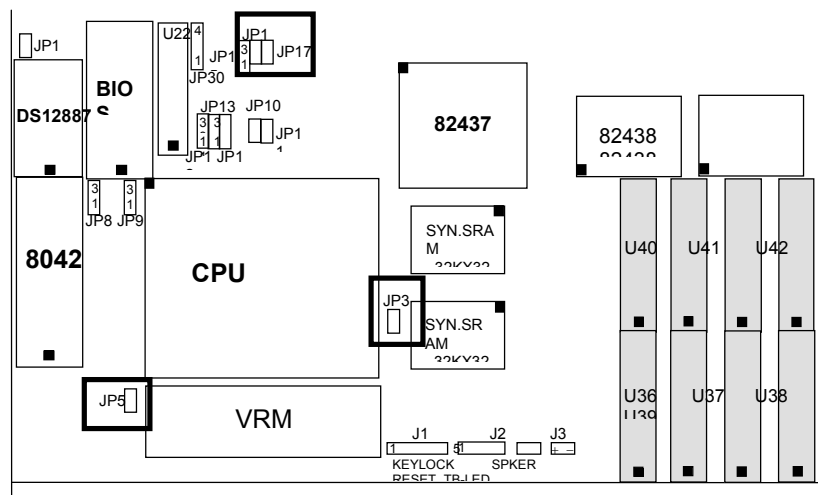

AMD 5_K86/INTEL PENTIUM FREQUENCY SETTING

50MHZ	♣60MHZ	66MHZ
JP1 <input type="checkbox"/>	JP16 <input type="checkbox"/>	JP16 <input checked="" type="checkbox"/>
JP1 <input type="checkbox"/>	JP1 <input checked="" type="checkbox"/>	JP17 <input checked="" type="checkbox"/>





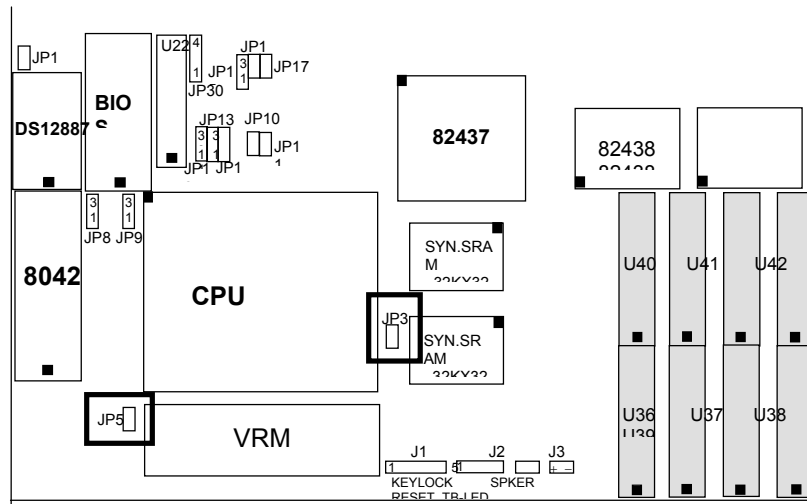

CPU FREQUENCY TIMES

♣1.5	2	2.5	3
JP <input type="text"/>	JP <input checked="" type="checkbox"/>	JP <input checked="" type="checkbox"/>	JP5 <input type="text"/>
JP3 <input type="text"/>	JP3 <input type="text"/>	JP3 <input checked="" type="checkbox"/>	JP3 <input checked="" type="checkbox"/>

♣ Default Setting



CYRIX 6x86 CPU FREQUENCY SETTING

CPU TYPE	FREQUENCY	JUMPER SETTING
6x86-120 ⁺	50MHZ	JP  JP3 
6x86-150 ⁺	60MHZ	JP  JP3 
6x86-166 ⁺	66MHZ	JP  JP3 

NOTE: FREQUENCY mean CPU FREQUENCY SETTING (on Page 6).

So you must set JP16, JP17 Jumper.

2.4 CPU TYPE REFERENCE SETTING

CPU TYPE	FREQUENCY	TIMES
PENTIUM 75	50MHZ	1.5
PENTIUM 90	60MHZ	1.5
PENTIUM 100	66MHZ	1.5
PENTIUM 120	60MHZ	2
PENTIUM 133	66MHZ	2
PENTIUM 150	60MHZ	2.5
PENTIUM 166	66MHZ	2.5
PENTIUM 200	66MHZ	3
CYRIX 6x86-120 ⁺ (100MHZ)	50MHZ	2
CYRIX 6x86-150 ⁺ (120MHZ)	60MHZ	2
CYRIX 6x86-166 ⁺ (133MHZ)	66MHZ	2
AMD 5 _k 86-P75	50MHZ	1.5
AMD 5 _k 86-P90	60MHZ	1.5

2.5 IDE SELECT

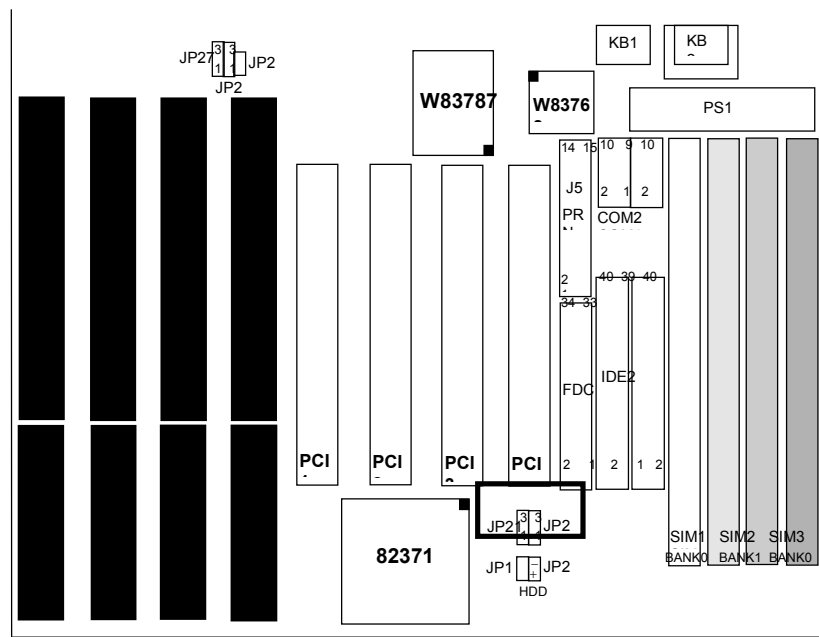

DEFAULT	FEATURE FUNCTION
<p>JP2</p>	<p>JP2</p>
<p>---</p>	<p>JP22</p>

2.6 FLASH ROM INSTALLATION

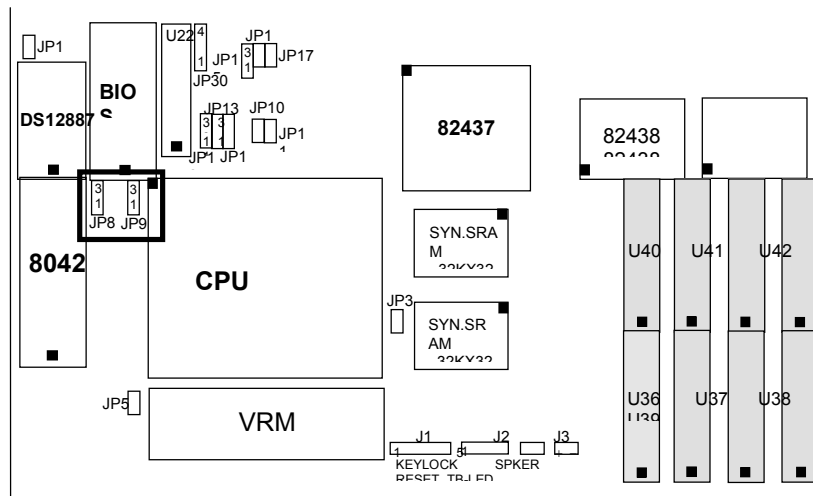

EPROM	♣5V FLASH ROM	12V FLASH ROM

♣ Default Setting

2.7 EPP MODE SETTING

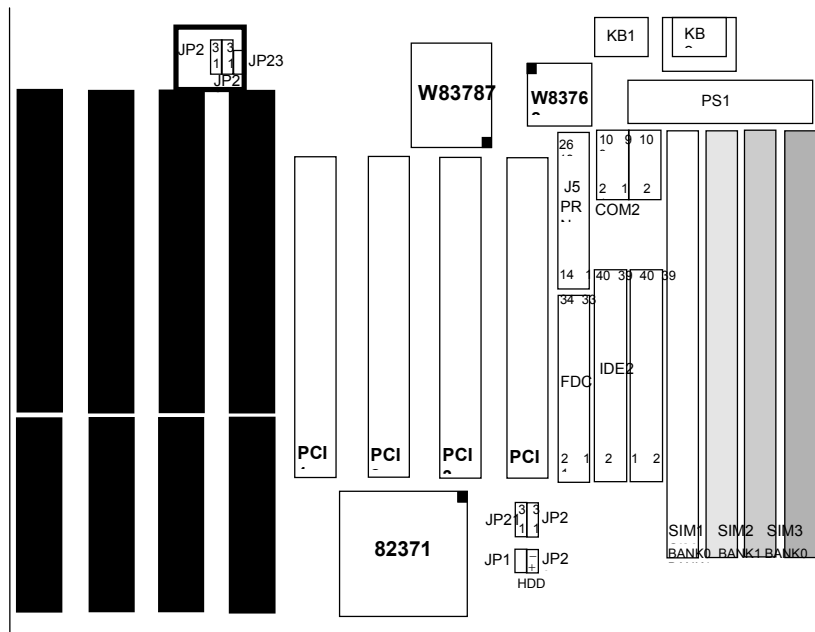

DMA CHANNEL CONFIGURATION

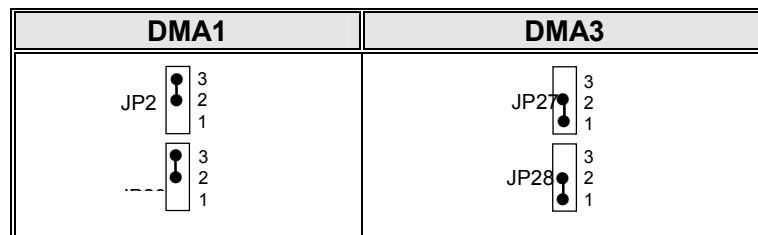

2.8 OTHER JUMPER & CONNECTOR INSTALLATION

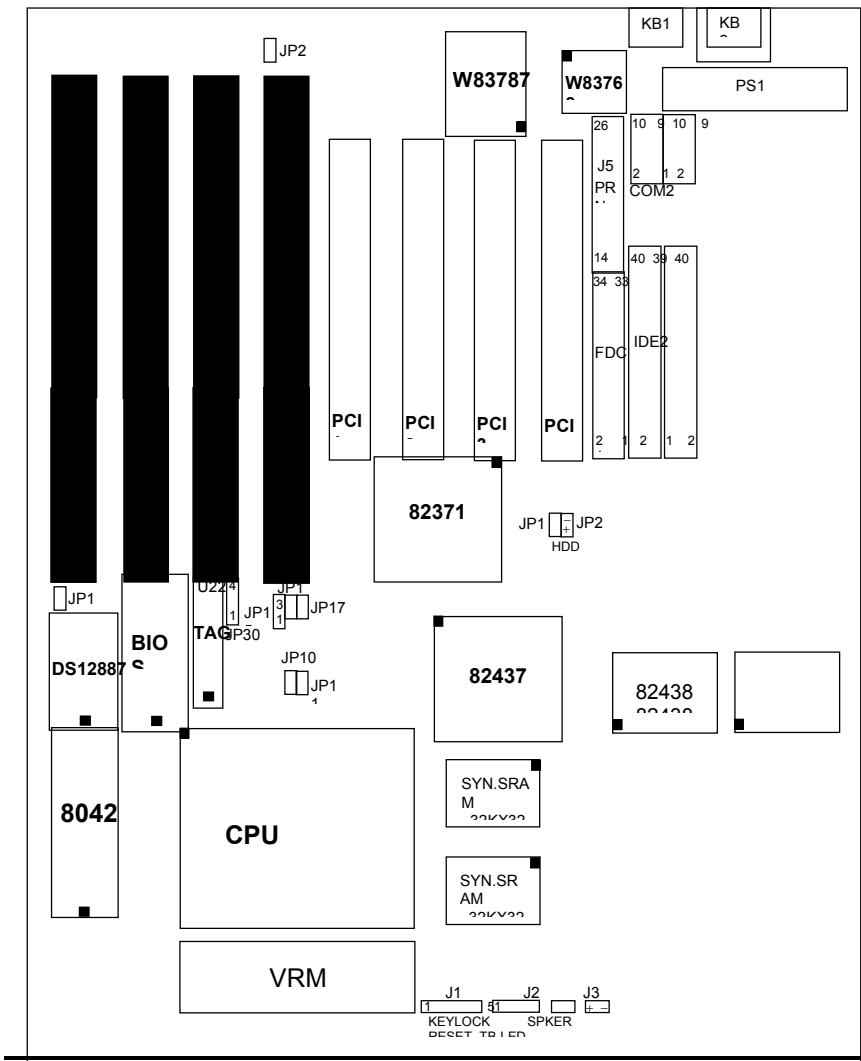

OTHER JUMPER DESCRIPTION

JUMPER	DESCRIPTION	
JP10	<input type="checkbox"/> INTERNAL CACHE WRITE BACK ♣	<input checked="" type="checkbox"/> INTERNAL CACHE WRITE THROUGH
JP11	<input type="checkbox"/> CPU PIPELINE DISABLE	<input checked="" type="checkbox"/> CPU PIPELINE ENABLE ♣
JP15	<input checked="" type="checkbox"/> AT BUS CLOCK EQUAL PCICLK/3 (FOR FREQUENCY 50MHZ)	<input checked="" type="checkbox"/> AT BUS CLOCK PCICLK/4 ♣ (FOR FREQUENCY 60, 66MHZ)
JP18	<input type="checkbox"/> NORMAL	<input checked="" type="checkbox"/> CLEAR CMOS
JP19	<input type="checkbox"/> NORMAL MODE	<input checked="" type="checkbox"/> SMI MODE
JP23	<input type="checkbox"/> FOR PARALLEL PORT EPP MODE	<input checked="" type="checkbox"/> FOR STANDARD PARALLEL PORT ♣

♣ Default Setting

CONNECTOR DESCRIPTION

CONNECT OR	PIN OUT	SIGNAL NAME
J1 KEY LOCK	1 2 3 4 5	LED POWER NOT USED GROUND KEYBOARD INHIBITOR GROUND
J2 SPEAKER	1 2 3 4	DATA OUT NOT USED GROUND +5V DC
J3 RESET	1 2	GROUND RESET IN
J4 TB-LED	1 2	+ANODE -CATHODE
JP20 HDD LED	1 2	+ANODE -CATHODE
JP30 CPU FAN CONNECTOR	1 2 3 4	GROUND GROUND GROUND +12V

CHAPTER 3 SYSTEM BIOS SETUP

WinBIOS Setup can be accessed via keyboard, mouse, or pen. The mouse click functions are:

- single click change or select both global and current fields and
- double click to perform an operation in the selected field.

Using the keyboard with WinBIOS Setup

WinBIOS Setup has a built-in keyboard driver that uses simple keystroke combinations:

KEYSTROKE	FUNCTION
<Tab>	Move to the next window or field.
→,←,↑,↓	Move to the next field to the right, left, above, or below.
<Enter>	Select in the current field.
+	Increments a value.
-	Decrements a value.
<Esc>	Closes the current operation and return to previous level.
<PgUp>	Returns to the previous page.
<PgDn>	Advances to the next page.
<Home>	Returns to the beginning of the text.
<End>	Advances to the end of the text.
<Alt>, <H>	Access a help window.
<Alt>, <Spacebar>	Exit WinBIOS Setup.
Alphabetic keys	A to Z are used in the Virtual Keyboard, and are not case sensitive.
Numeric Keys	0 to 9 are used in the Virtual Keyboard and Numeric Keypad.

EXP8551 User's Manual

The hardware features and options of the *EXP8551* are on-site selectable for maximum flexibility. You will need to configure these options through the built-in Setup Utility prior to using *EXP8551* for the first time. This setup Utility is a multi-screen, menu driven program and is contained within the BIOS EPROM.

The following sections show the procedures that you may need to configure the EXP8551:

1. Presswhile turning on or rebooting the system to invoke Setup Utility program.
2. The main menu will be shown as follows:

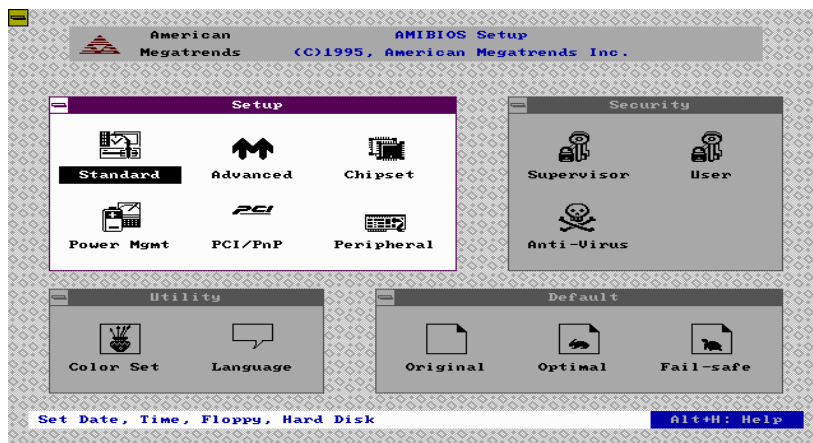

Figure 1

3. The functions are grouped into four categories which are Setup, Utility, Security and Default.
4. By using <TAB>key or mouse cursor to select the function group.
5. Use arrow keys or mouse to select the function icon within the group. Then press <Enter>key to invoke the setup function.
6. Use<Esc>key to go back to the previous screen.

3.1 SYSTEM SETUP

3.1.1 Advanced Setup

Optimal Setting

You can load the optimal default settings for the WINBIOS by pressing the "END" key upon power-up. The Optimal default settings are best-case values that should optimize system performance. The Optimal settings will automatically detect and load the parameter of hard disk type.

Advanced Setup

Advanced Setup options are displayed by choosing the Advanced icon from the WINBIOS Setup main menu. All Advanced Setup options are described in this section.

Quick Boot

Set this option to *Enabled* to instruct AMIBIOS to boot quickly when the computer is powered on. This option replaces the old **Above 1 MB Memory Test** Advanced Setup option. The settings are:

Setting	Description
Disabled	AMIBIOS test all system memory. AMIBIOS waits up to 40 seconds for a READY signal from the IDE hard disk drive. AMIBIOS waits for .5 seconds after sending a RESET signal to the IDE drive to allow the IDE drive time to get ready again. AMIBIOS checks for a key press and runs WINBIOS Setup if the key has been pressed.
Enabled	AMIBIOS does not test system memory above 1 MB. AMIBIOS does not wait up to 40 seconds for a READY signal from the IDE hard disk drive. If a READY signal is not received immediately from the IDE drive, AMIBIOS does not configure that drive. AMIBIOS does not wait for .5 seconds after sending a RESET signal to the IDE drive to allow the IDE drive time to get ready again. You cannot run WINBIOS Setup at system boot, because there is no delay for the <i>Hit to run Setup</i> message.

The Optimal and Fail-Safe default settings are *Enabled*.

OS/2 Compatible Mode

Set this option to *Enabled* to permit AMIBIOS to run with IBM OS/2. The settings are *Enabled* or *Disabled*. The default settings are *Disabled*.

System BIOS Cacheable

When this option is set to *Enabled*, the contents of the F0000h system memory segment can be read from or written to L2 secondary cache memory. The contents of the F0000h memory segment are always copied from the BIOS ROM to system RAM for faster execution.

The settings are *Enabled* or *Disabled*. The Optimal default setting is *Enabled*. The Fail-Safe default setting is *Disabled*.

3.1.2 Power Management Setup

Power Management Setup options are displayed by choosing the Power Mgmt icon from the WINBIOS Setup main menu. All Power Management Setup options are described in this section.

Power Management/APM

Set this option to *Enabled* to enable the power management and APM (Advanced Power Management) features. The settings are *Enabled* or *Disabled*. The default settings are *Disabled*.

Instant On Timeout

Set this option to *Enabled* to allow the computer to go to full power on mode when leaving a power-conserving state. *This option is only available if supported by the computer hardware.* AMIBIOS uses the RTC Alarm function to wake the computer at a prespecified time. The settings are *Enabled* or *Disabled*. The default settings are *Disabled*.

Green PC Monitor Power State

This option specifies the power management state that the Green PC-compliant video monitor enters after the specified period of display inactivity

has expired. The settings are *Disabled*, *Off*, *Standby*, or *Suspend*. The default settings are *Disabled*.

Video Power Down Mode

This option specifies the power management state that the video subsystem enters after the specified period of display inactivity has expired. The settings are *Disabled*, *Standby*, or *Suspend*. The default settings are *Disabled*.

Hard Disk Power Down Mode

This option specifies the power management state that the hard disk drive enters after the specified period of display inactivity has expired. The settings are *Disabled*, *Standby*, or *Suspend*. The default settings are *Disabled*.

Hard Disk Time out (Min)

This option specifies the length of a period of hard disk inactivity. When this period expires, the hard disk drive enters the power-conserving mode specified in the **Hard Disk Power Down Mode** option described on the previous page. The settings are *Disabled*, *1 Min (minutes)*, and all one minute intervals up to and including *15 Min*. The default settings are *Disabled*.

Standby Time out

This option specifies the length of the period of system inactivity when the computer is in Full-On mode before the computer is placed in Standby mode. In Standby mode, some power use is curtailed. The settings are *Disabled*, *1 Min*, *2 Min*, and all one minute intervals up to and including *15 Min*. The default settings are *Disabled*.

Suspend Time out

This option specifies the length of the period of system inactivity when the computer is already in Standby mode before the computer is placed in Suspend mode. In Suspend mode, nearly all power use is curtailed. The settings are *Disabled*, *1 Min*, *2 Min*, and all one minute intervals up to and including *15 Min*. The default settings are *Disabled*.

Slow Clock Ratio

This option specifies the speed at which the system clock runs in power saving modes. The settings are expressed as a ratio between the normal clock speed and the power down clock speed. The settings are *1:1*, *1:2* (half as fast as normal), *1:4* (the normal clock speed), *1:8*, *1:16*, *1:32*, *1:64*, or *1:128*. The default setting is *1:1*.

Display Activity

This option specifies if AMIBIOS is to monitor activity on the display monitor for power conservation purposes. When this option is set to *Monitor* and there is no display activity for the length of time specified in the value in the **Full-On to Standby Timeout (Min)** option, the computer enters a power saving state. The settings are *Monitor* or *Ignore*. The default settings are *Ignore*.

IRQ XX

These options enable event monitoring. When the computer is in a power saving mode, activity on the named interrupt request line is monitored by AMIBIOS. When any activity occurs, the computer enters Full On mode. Each of these options can be set to *Monitor* or *Ignore*. The default setting for all options is *Ignore*.

3.1.3 PCI/PnP Setup

PCI/PnP Setup options are displayed by choosing the PCI/PnP Setup icon from the WINBIOS Setup main menu. All PCI/PnP Setup options are described in this section

Plug and Play Aware O/S

Set this option to *Yes* if the operating system installed in the computer is Plug and Play-aware. AMIBIOS only detects and enables PnP ISA adapter cards that are required for system boot. The Windows 95 operating system

detects and enables all other PnP-aware adapter cards. Windows 95 is PnP-aware. Set this option to *No* if the operating system (such as DOS, OS/2, Windows 3.x) does not use PnP. *You must set this option correctly or PnP-aware adapter cards installed in your computer will not be configured properly.* The settings are *No* or *Yes*. The Optimal and Fail-Safe default settings are *No*.

PCI Burst Mode

Set this option to *Enabled* to enable PCI burst mode. The settings are *Disabled* or *Enabled*. The Optimal default setting is *Enabled*. The Fail-Safe default setting is *Disabled*.

PCI Latency Timer (PCI Clocks)

This option sets latency of all PCI devices on the PCI bus. The settings are in units equal to PCI clocks. The settings are *32, 64, 96, 128, 160, 192, 224, or 248*. The Optimal and Fail-Safe default settings are *64*.

PCI VGA Palette Snoop

This option must be set to *Enabled* if any ISA adapter card installed in the computer requires VGA palette snooping. The settings are *Disabled* or *Enabled*. The Optimal and Fail-Safe default settings are *Disabled*.

PCI IDE BusMaster

Set this option to *Enabled* to specify that the IDE controller on the PCI local bus has bus mastering capability. The settings are *Disabled* or *Enabled*. The Optimal and Fail-Safe default settings are *Disabled*.

Offboard PCI IDE Card

This option specifies if an offboard PCI IDE controller adapter card is used in the computer. You must also specify the PCI expansion slot on the motherboard where the offboard PCI IDE controller card is installed. If an offboard PCI IDE controller is used, the onboard IDE controller on the motherboard is automatically disabled. The settings are *Disabled, Auto, Slot1, Slot2, Slot3, or Slot4*.

If *Auto* is selected, AMIBIOS automatically determines the correct setting for this option. The Optimal and Fail-Safe default settings are *Auto*.

In the AMIBIOS for the Intel Triton chipset, this option forces IRQ 14 and 15 to a PCI slot on the PCI local bus. This is necessary to support non-compliant PCI IDE adapter cards.

Offboard PCI IDE Primary IRQ

This option specifies the PCI interrupt used by the primary IDE channel on the offboard PCI IDE controller. The settings are *Disabled*, *INTA*, *INTB*, *INTC*, or *INTD*. The Optimal and Fail-Safe default settings are *Disabled*.

Offboard PCI IDE Secondary IRQ

This option specifies the PCI interrupt used by the secondary IDE channel on the offboard PCI IDE controller. The settings are *Disabled*, *INTA*, *INTB*, *INTC*, or *INTD*. The Optimal and Fail-Safe default settings are *Disabled*.

PCI/PnP Setup

These options specify the bus that the named interrupt request lines (IRQs) are used on. These options allow you to specify IRQs for use by legacy ISA adapter cards.

These options determine if AMIBIOS should remove an IRQ from the pool of available IRQs passed to BIOS configurable devices. The available IRQ pool is determined by reading the ESCD NVRAM. If more IRQs must be removed from the pool, the end user can use these PCI/PnP Setup options to remove the IRQ by assigning the option to the *ISA/EISA* setting. Onboard I/O is configurable by AMIBIOS. The IRQs used by onboard I/O are configured as *PCI/PnP*.

The settings are *PCI/PnP* or *ISA/EISA*. The Optimal and Fail-Safe default settings are *PCI/PnP*.

Reserved Memory Size

This option specifies the size of the memory area reserved for legacy ISA adapter cards.

The settings are *Disabled*, *16K*, *32K*, or *64K*. The Optimal and Fail-Safe default settings are *Disabled*.

Reserved Memory Address

This option specifies the beginning address (in hex) of the reserved

EXP8551 User's Manual

memory area. The specified ROM memory area is reserved for use by legacy ISA adapter cards.

The settings are *C0000*, *C4000*, *C8000*, *CC000*, *D0000*, *D4000*, *D8000*, or *DC000*. The Optimal and Fail-Safe default settings are *C0000*.

3.2 Security Setup

WinBIOS Setup has an optional password feature. The system can be configured so that all users must enter a password every time the system boots or when WinBIOS Setup is executed. The following screen appears when you select the password icon.

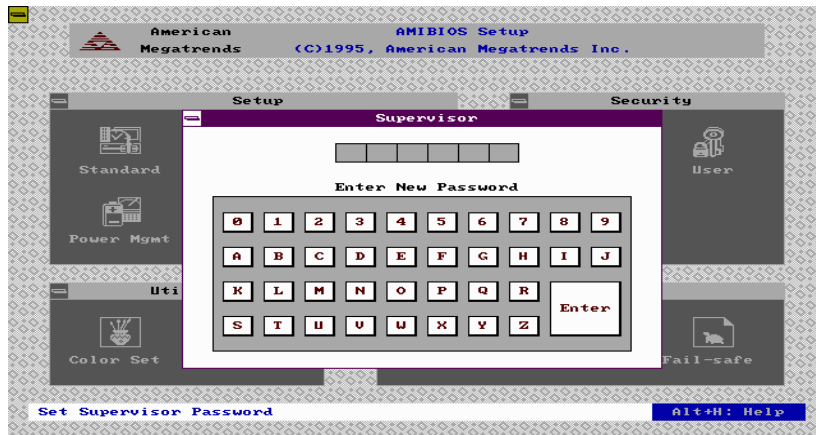

Figure 2

You can enter a password by:

- typing the password on the keyboard,
- selecting each letter via the mouse, or
- selecting each letter via the pan stylus.

Pen access must be customized for each specific hardware platform.

The password check option is enabled in Advanced Setup by choosing either Always (the password prompt appears every time the system is powered on) or Setup (the password prompt appears only when WinBIOS Setup is run). The password is stored in CMOS RAM. The system asks for a password.

Enter a 1-6 character password. The password does not appear on the screen when typed. WinBIOS will ask you to retype the password. Make sure you write it down. If you forget it, you must drain CMOS RAM and reconfigure the system. WinBIOS will then display the following:

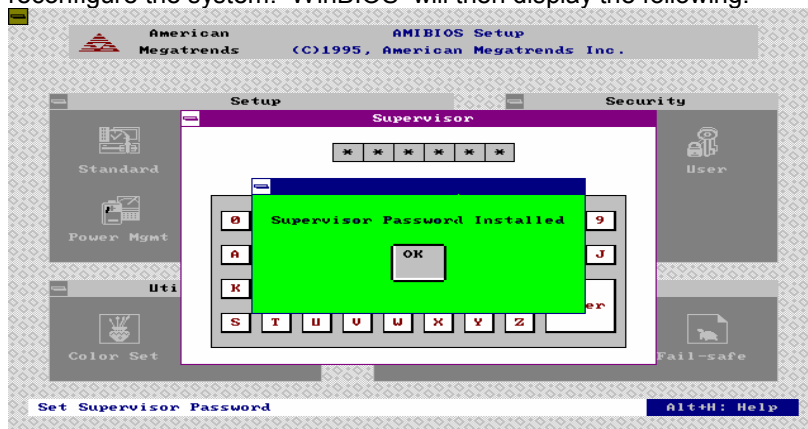

Figure 3

Select the Password icon from the Security section of the WinBIOS Setup main menu. Enter the password and press <Enter>. The screen does not display the characters entered. After the new password is entered, retype the new password as prompted and press<Enter>.

If the password confirmation is incorrect, an error message appears. If the new password is entered without error, press<Esc>to return to the WinBIOS Setup Main Menu. The password is stored in CMOS RAM after WinBIOS Setup completes. The next time the system boots, you are prompted for the password if the password function is present and is enabled.

Remember the Password

Keep a record of the new password when the password is changed. If you forget the password and you computer has an American Megatrends motherboard, remove the computer cover, set switch 1-2 (the DIAG switch) to ON, power on the computer. WinBIOS erases the password.

When this icon is selected from the Security section of the WinBIOS Setup main menu, WinBIOS issues a warning when any program (or virus) issues a Disk Format command or attempts to write to the boot sector of the hard disk drive. The following screen appears when you select the Anti-Virus icon:

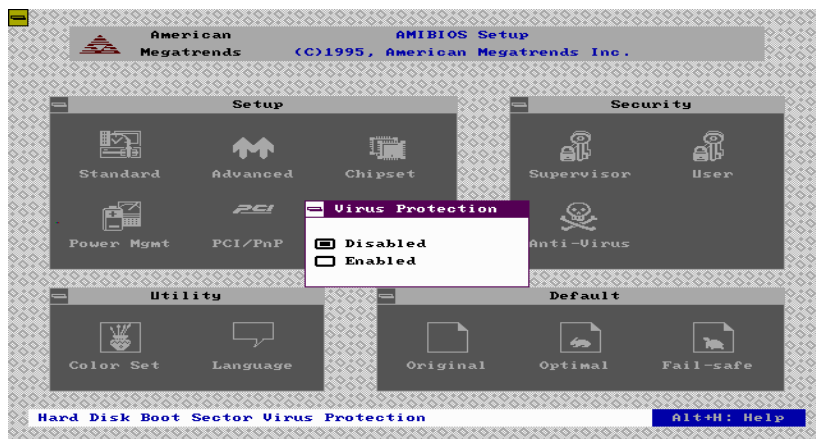

Figure 4

The settings are Enabled or Disabled. If enabled, the following warning appears when a write is attempted to the boot sector. You may have to type N several times to prevent the boot sector write.

3.3 Default Setup

The icons in this section permit you to select a group of settings for all WinBIOS Setup options. Not only can you use these icons to quickly set system configuration parameters, you can choose a group of settings that have a better chance of working when the system is having configuration-related problems.

Original

Choose the Original icon to return to the system configuration values present in WinBIOS Setup when you first began this WinBIOS Setup session.

Optimal

You can load the optimal default settings for the WinBIOS Setup options by selecting the Optimal icon. The Optimal default settings are best-case values that should optimize system performance. If CMOS RAM is corrupted, the Optimal settings are loaded automatically.

Fail-Safe

You can load the Fail-Safe WinBIOS Setup option settings by selecting the Fail-Safe icon from the Default section of the WinBIOS Setup main menu.

The Fail-Safe settings provide far from optimal system performance, but are the most stable settings. Use this option as a diagnostic aid if the system is behaving erratically.

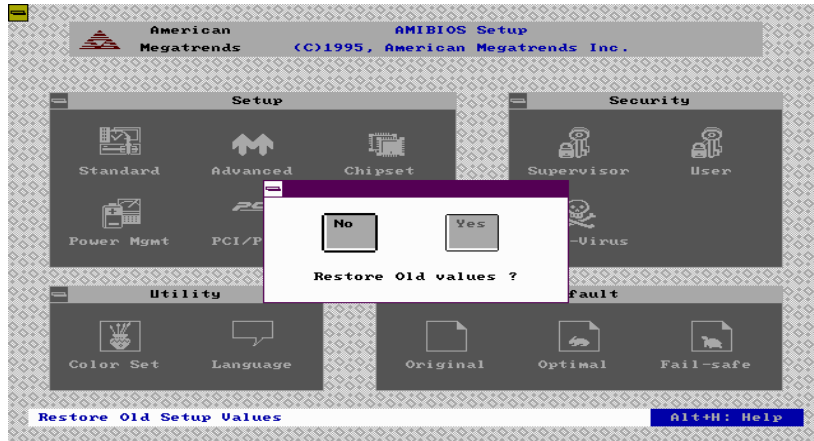

Figure 5

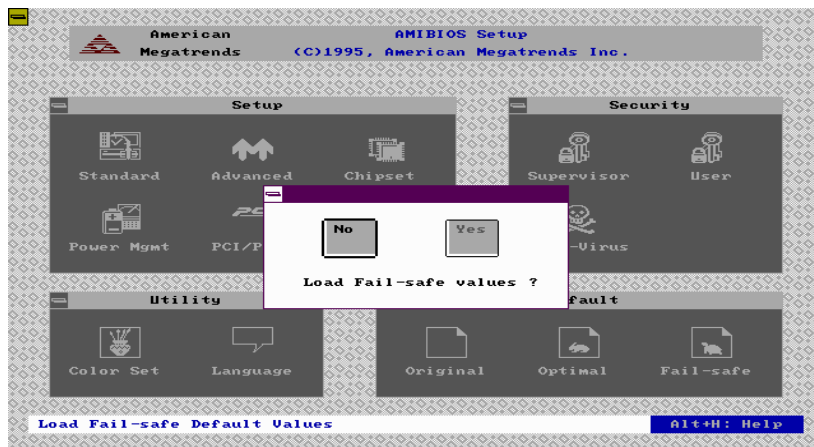

Figure 6

WINBIOS BEEP CODES

BEEPS	ERROR MESSAGE	DESCRIPTION
1	Refresh Failure	The memory refresh circuitry is faulty.
2	Parity error	Parity error in the base memory (the first 64 KB block) of memory.
3	Base 64 KB Memory Failure	Memory failure in first 64 KB.
4	Timer Not Operational	A memory failure in the first 64 KB of memory, or Timer is not functioning.
5	Processor error	The CPU generated an error.
6	8042-Gate A20 Failure	Cannot switch to protected mode.
7	Processor exception interrupt Error	The CPU on the CPU Card generated an exception interrupt.
8	Display Memory Read/Write Error	The system video adapter is either missing or its memory is faulty. This is not a fatal error.
9	ROM Checksum Error	The ROM checksum value does not match the value encoded in WinBIOS.
10	CMOS Shutdown Register Read/Write Error	The shutdown register for CMOS RAM has failed.
11	Cache memory bad-do not enable cache	The cache memory test failed. Cache memory is disabled. Do not press<Ctrl><Alt><+> to enable cache memory.

What to Do If the Computer Beeps

Here is what you need to do if your computer has a WinBIOS and it starts beeping:

IF THE SYSTEM BEEPS.....	THEM...
1, 2, or 3 times...	Reseat the memory SIMMs or DIPs. If the system still beeps, replace the memory.
6 times...	Reseat the keyboard controller chip. If it still beeps, replace the keyboard controller. If it still beeps, try a different keyboard, or replace the keyboard fuse, if the keyboard has one.
8 times...	There is a memory error on the video adapter. Replace the video adapter , or the RAM on the video adapter.
9 times...	The BIOS ROM chip is bad. The system probably needs a new BIOS ROM chip.
11 times...	Reseat the cache memory on the motherboard. If it still beeps, replace the cache memory.
4, 5, 7 or 10 times...	The motherboard must be replaced.

RMA FORM

When the motherboard can not work well, please fill up this form to describe related situations. If the space is not enough to use, you can attach separate paper.

MODEL:

MODEL NO:

HARDWARE

CPU: Brand _____, Model _____, Speed _____ MHz

CD-PROCESSOR: Brand _____, Model _____, Speed _____ MHz

SIMM: Brand _____, Speed _____ ns, Q'ty _____ pcs, Total _____ MB

CACHE: Brand _____, Speed _____ ns, Total _____ K

TAG RAM: Brand _____, Speed _____ ns

BIOS DATA CODE: _____

SYSTEM SPEED RUNNING _____ MHz

VIDEO CARD: Chip _____, RAM _____, VGA Mode _____ Bus _____ (ISA, VESA or PCI)

OTHER ADD-ON CARDS:

SOFTWARE

OPERATING SYSTEM _____ VERSION _____

SOFTWARE PROGRAM _____

BIOS SETUP: DRAM Wait State _____ CACHE Wait State _____

If you change BIOS SETUP, please describe the changes:

<A>ERROR

HANG UP

NO SCREEN

FLOPPY R/W ERROR

HARD DISK R/W ERROR

PARITY MEMORY ERROR

OTHER _____

ERROR MESSAGES ON YOUR SCREEN (PLEASE SHOW US THE WHOLE SENTENCE)

<C>PROBLEM DESCRIPTION