

# AP5VM

## User's Guide

**Printed in Taiwan**

**PART NO.: 49.87530.021**

**DOC. NO.: AP5VM-3-E9711E**



# **AP5VM**

## **Mainboard**

User's Guide

**Document Number** : AP5VM-3-E9711E  
**Model and Revision** : For AP5VM revision 2.xx and 3.xx  
**Manual Version** : English, version E  
**Release Date** : Nov 13, 1997

*More help for latest information:*

**Taiwan**      <http://www.aopen.com.tw>  
**USA**          <http://www.aopen-usa.com>  
                  <http://www.aopenamerica.com>  
**Europe**      <http://www.aopen.nl>

---

## Copyright

Copyright © 1997 by this company. All rights reserved. No part of this publication may be reproduced, transmitted, transcribed, stored in a retrieval system, or translated into any language or computer language, in any form or by any means, electronic, mechanical, magnetic, optical, manual or otherwise, without the prior written permission of this company.

---

## Disclaimer

This company makes no representations or warranties, either expressed or implied, with respect to the contents hereof and specifically disclaims any warranties, merchantability or fitness for any particular purpose. Any software described in this manual is sold or licensed "as is". Should the programs prove defective following their purchase, the buyer (and not this company, its distributor, or its dealer) assumes the entire cost of all necessary servicing, repair, and any incidental or consequential damages resulting from any defect in the software. Further, this company reserves the right to revise this publication and to make changes from time to time in the contents hereof without obligation to notify any person of such revision or changes.

Intel and Pentium are registered trademarks of Intel Corporation.

XT/AT is a registered trademark of International Business Machines Corporation.

AMI is a registered trademark of American Megatrends Inc.

AWARD is a registered trademark of Award Software Inc.

Other brand and product names are trademarks and/or registered trademarks of their respective holders.

---

## FCC Class B Radio Frequency

### Declaration of Conformity

This equipment has been tested and found to comply with the limits for a Class B digital device, pursuant to Part 15 of FCC Rules. These limits are designed to provide reasonable protection against harmful interference in a residential installation. This equipment generates, uses, and can radiate radio frequency energy and, if not installed and used in accordance with the instructions, may cause harmful interference to radio communications. However, there is no guarantee that interference will not occur in a particular installation. If this equipment does cause harmful interference to radio or television reception, which can be determined by turning the equipment off and on, the user is encouraged to try to correct the interference by one or more of the following measures:

1. Reorient or relocate the receiving antenna.
2. Increase the separation between the equipment and receiver.
3. Connect the equipment into an outlet on a circuit different from that to which the receiver is connected.
4. Consult the dealer or an experienced radio/television technician for help.

#### **Notice 1:**

The changes or modifications not expressly approved by the party responsible for compliance could void the user's authority to operate the equipment.

#### **Notice 2:**

Shielded interface cables, if any, must be used in order to comply with emission limits.

---

## Purpose and Scope

This manual tells how to install and configure the system board.

## Organization

Chapter 1, **Overview**, covers the introduction and specifications of the system board.

Chapter 2, **Hardware Installation**, describes hardware jumpers, connectors and memory configuration. There are user friendly drawings to locate jumper and connector.

Chapter 3, **AMI BIOS**, explains the system BIOS and tells how to configure the system by setting the BIOS parameters.

Chapter 4, **Installing System Component**, includes 3D drawing and step by step procedures for first time DIY user to install the system board, CPU, SIMM/DIMM, cable and add expansion cards.

Appendix A, **Jumper Table Summary**, gives you a tabular summary of the jumper settings discussed in Chapter 2.

Appendix B, **Frequently Asked Question**, collects most frequently asked question of this product.

Appendix C, **Troubleshooting Guide**, includes first aid information you need if you meet trouble, the WWW address and worldwide service telephone/fax are also included.

Appendix D, **AOpen Best Products**, includes the best sale and recommended product specifications of AOpen.

---

## Conventions

The following conventions are used in this manual:

Text entered by user, default settings, recommended selections

Represent text input by the user, default settings and recommended selections

<Enter>, <Tab>,<Ctl>, <Alt>, <Ins>, <Del>, etc

Represent the actual keys that you have to press on the keyboard.



**Note:**

Gives bits and pieces of additional information related to the current topic.



**Warning:**

Alerts you to any damage that might result from doing or not doing specific actions.



**Caution:**

Suggests precautionary measures to avoid potential hardware or software problems.



**Important:**

Reminds you to take specific action relevant to the accomplishment of the procedure at hand.



**Tip:**

Tells how to accomplish a procedure with minimum steps through little shortcuts.



---

## Contents

<b>Chapter 1</b>	<b>Overview</b>	
<b>1.1</b>	<b>Specifications .....</b>	<b>1-2</b>
<b>Chapter 2</b>	<b>Hardware Installation</b>	
<b>2.1</b>	<b>Jumper and Connector Locations.....</b>	<b>2-2</b>
<b>2.2</b>	<b>Jumpers.....</b>	<b>2-4</b>
2.2.1	Setting the CPU Voltage.....	2-5
2.2.2	Selecting the CPU Frequency.....	2-9
2.2.3	Disabling the Onboard Super I/O Controller.....	2-12
2.2.4	Disabling the PS/2 Mouse Function.....	2-13
2.2.5	Clearing the CMOS.....	2-14
2.2.6	Selecting the DIMM Type.....	2-15
<b>2.3</b>	<b>Connectors.....</b>	<b>2-16</b>
2.3.1	Power Cable.....	2-16
2.3.2	CPU Fan.....	2-17
2.3.3	PS/2 Mouse.....	2-17
2.3.4	Serial Devices (COM1/COM2).....	2-18
2.3.5	USB Device (optional).....	2-19
2.3.6	Floppy Drive.....	2-20

---

2.3.7	Printer.....	2-20
2.3.8	IDE Hard Disk and CD ROM.....	2-21
2.3.9	Hard Disk LED.....	2-23
2.3.10	Panel Connector.....	2-24
2.3.11	Keyboard.....	2-26
2.3.12	IrDA Connector.....	2-27
<b>2.4</b>	<b>Configuring the System Memory .....</b>	<b>2-28</b>

**Chapter 3**      **AMI BIOS**

<b>3.1</b>	<b>Entering the AMI BIOS Setup.....</b>	<b>3-1</b>
<b>3.2</b>	<b>Setup Menu .....</b>	<b>3-3</b>
3.2.1	Standard Setup .....	3-3
3.2.2	Advanced Setup .....	3-7
3.2.3	Chipset Setup .....	3-12
3.2.4	Power Management Setup .....	3-16
3.2.5	PCI/PnP Setup .....	3-19
3.2.6	Peripheral Setup.....	3-22
<b>3.3</b>	<b>Security Setup.....</b>	<b>3-24</b>
<b>3.4</b>	<b>Utility Setup .....</b>	<b>3-27</b>
<b>3.5</b>	<b>Default Setup.....</b>	<b>3-28</b>
<b>3.6</b>	<b>Exiting Setup.....</b>	<b>3-30</b>

---

**3.7 Onboard NCR SCSI BIOS .....3-31**

**3.8 AMI Flash Utility .....3-31**

**Chapter 4 Installing System Component**

**4.1 Installing Memory Module .....4-1**

4.1.1 Installing a SIMM.....4-2

4.1.2 Removing a SIMM.....4-2

4.1.3 Installing a DIMM.....4-3

4.1.4 Removing a DIMM.....4-4

**4.2 Installing or Upgrading a CPU .....4-4**

**4.3 Installing the System Board.....4-5**

**4.4 Accesory Bracket and Cables.....4-6**

4.4.1 Baby AT (PS/2) Power Cable.....4-7

4.4.2 Serial Port Bracket (COM1/COM2)..4 -7

4.4.3 PS/2 Mouse Bracket.....4-8

4.4.4 Printer Bracket.....4-8

4.4.5 USB Bracket.....4-9

4.4.6 Floppy Cable.....4-9

4.4.7 IDE Cables for HDD and  
CDROM.....4-10

4.4.8 Front-panel Switch and LED  
Cables.....4-10

---

**4.5 Installing Add-on Cards .....4-11**

**Appendix A Jumper Table Summary**

**Appendix B Frequently Asked Question**

**Appendix C Troubleshooting**

**Appendix D AOpen Best Products**

---

# Chapter 1

## Overview

The AP5VM is a high-performance Pentium®-based system board that utilizes the PCI/ISA architecture. It integrates the **Intel 82430VX PCiset**, a **super I/O controller**, and a PCI mode 4 enhanced IDE controller with bus master support to enhance system performance. It has **four single in-line memory module (SIMM)** sockets and **one Dual in-line memory module (DIMM)** that allow system memory expansion up to a maximum of **128MB**. It also supports **256KB and 512KB pipelined-burst second-level cache onboard**.

One main feature of AP5VM is the green power-management function that extends energy conservation from system components to display monitor. It complies with the power-saving standards of the U.S. Environmental Protection Agency (EPA) Energy Star program.

The AP5VM board measures 220 mm x 280 mm.

## Overview

---

### 1.1 Specifications

<b>Form Factor</b>	Baby AT
<b>Board Size</b>	220 mm x 280 mm
<b>CPU</b>	Intel Pentium Processor P54C, PP/MT (P55C), AMD K5/K6, Cyrix 6x86/6x86MX and IDT C6.
<b>System Memory</b>	FPM (Fast Page Mode) or EDO (Extended Data Output) 72-pin SIMM x4, and SDRAM 168-pin x1 maximum 128MB.
<b>Second-level Cache</b>	256KB or 512KB pipelined-burst cache onboard
<b>Chipset</b>	Intel 82430VX PCIset
<b>Expansion Slots</b>	ISA x3 and PCI x4
<b>Serial Port</b>	Two serial ports UART 16C550 compatible
<b>Parallel Port</b>	One parallel port supports standard parallel port (SPP), enhanced parallel port (EPP) or extended capabilities port (ECP).
<b>Floppy Interface</b>	Floppy interface supports 3.5 inches drives with 720KB, 1.44MB or 2.88MB format or 5.25 inches drives with 360KB, 1.2MB format
<b>IDE Interface</b>	Dual-channel IDE interface support maximum 4 IDE hard disks or CDROM, mode 4 and bus master hard disk drives are also supported.
<b>USB Interface</b>	Two USB ports supported by USB bracket, the BIOS also supports USB driver to simulate legacy keyboard.
<b>PS/2 Mouse</b>	PS/2 mouse supported by PS/2 mouse bracket.
<b>Keyboard</b>	Default AT compatible keyboard, mini-DIN PS/2 keyboard connector is optional.
<b>BIOS</b>	AMI Plug-and-Play Flash ROM BIOS
<b>RTC</b>	Dallas DS12887A and DS12B887 compatible

---

## Chapter 2

### Hardware Installation

This chapter gives you a step-by-step procedure on how to install your system. Follow each section accordingly.



**Caution:** *Electrostatic discharge (ESD) can damage your processor, disk drives, expansion boards, and other components. Always observe the following precautions before you install a system component.*

1. *Do not remove a component from its protective packaging until you are ready to install it.*
2. *Wear a wrist ground strap and attach it to a metal part of the system unit before handling a component. If a wrist strap is not available, maintain contact with the system unit throughout any procedure requiring ESD protection.*

# Hardware Installation

## 2.1 Jumper and Connector Locations

The following figure shows the locations of the jumpers and connectors on the system board:

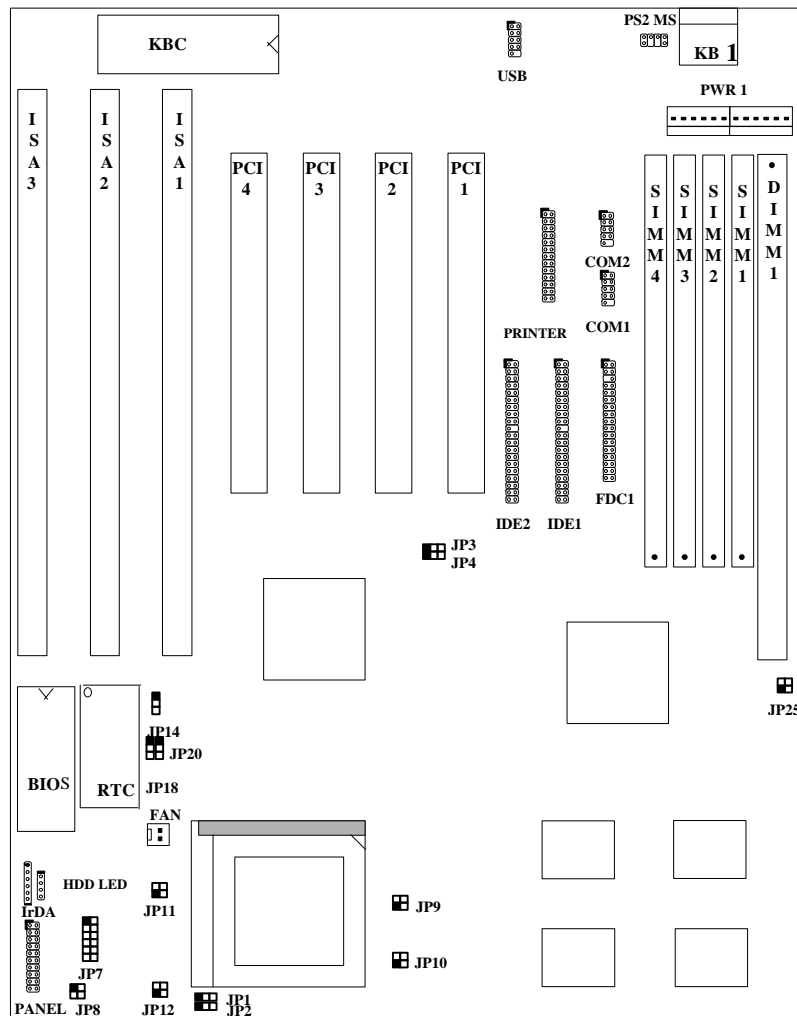



## Hardware Installation

---

### **Jumpers:**

<i>JP1,JP2:</i>	<i>CPU frequency ratio select</i>
<i>JP3,JP4:</i>	<i>CPU external (bus) clock select</i>
<i>JP7:</i>	<i>CPU core voltage setting (Vcore)</i>
<i>JP8:</i>	<i>I/O voltage setting (Vio)</i>
<i>JP9,JP10, JP11,JP12</i>	<i>CPU type (Single/Dual voltage, Vcpuio) selection</i>
<i>JP14:</i>	<i>For clearing CMOS</i>
<i>JP18:</i>	<i>Enable/disable onboard super I/O controller</i>
<i>JP20:</i>	<i>Enable/disable onboard PS/2 mouse</i>
<i>JP25:</i>	<i>DIMM memory type select</i>

### **Connectors:**

<i>KB1:</i>	<i>AT keyboard connector</i>
<i>PWR1:</i>	<i>AT (PS/2) power connector</i>
<i>PS2 MS:</i>	<i>PS/2 mouse connector</i>
<i>USB:</i>	<i>USB connector</i>
<i>COM1:</i>	<i>COM1 connector</i>
<i>COM2:</i>	<i>COM2 connector</i>
<i>FDC1:</i>	<i>Floppy drive connector</i>
<i>PRINTER:</i>	<i>Printer connector</i>
<i>IDE1:</i>	<i>IDE1 primary channel</i>
<i>IDE2:</i>	<i>IDE2 secondary channel</i>
<i>FAN:</i>	<i>CPU fan connector</i>
<i>IrDA:</i>	<i>IrDA (Infrared) connector</i>
<i>HDD LED:</i>	<i>HDD LED connector</i>
<i>PANEL:</i>	<i>Front-panel (Multifunction) connector</i>

## Hardware Installation

---

### 2.2 Jumper Settings

Board jumpers are made of pin headers and plastic connecting caps. These are included in the mainboard design to enable you to customize your hardware. The onboard jumpers are normally set to its default and optimum setting. Be sure you have basic knowledge of computer hardware and understand the function of the jumper before you change any setting.

Pin 1 of a jumper is indicated by a bold line on the mainboard. You may also find number indications on the board to specify the proper configuration of the jumper.

To set a jumper, simply connect the plastic cap to the required pins. For example, to set a jumper to 1-2, place the plastic cap on pins 1-2 of the jumper. An OPEN setting means that no plastic cap connected to the jumper pins.



Open



Short



Jumper set at 1-2



Jumper set at 2-3

## Hardware Installation

### 2.2.1 Setting the CPU Voltage

<b>JP7</b>	<b>CPU Core Voltage (Vcore)</b>
1-2	3.45V (Intel P54C or IDT C6)
3-4	3.52V (Cyrix or AMD K5)
5-6	2.9V (K6-166/200 or M2)
7-8	2.8V (MMX P55C)
9-10	3.2V (AMD K6-233)
11-12	2.1V (Reserved)

**JP7** is used to select CPU core voltage (Vcore), normally it is set to default 3.45V for INTEL Pentium P54C. It must be changed if you have CPU with different core voltage, such as INTEL PP/MT MMX (P55C), AMD K5/K6 and Cyrix 6x86, refer to the CPU specification for more details.

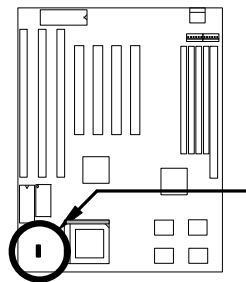

<b>JP7</b>	<b>JP7</b>	<b>JP7</b>	<b>JP7</b>	<b>JP7</b>
3.45V	3.52V	2.9V	2.8V	3.2V
P54C IDT C6	6x86 or K5	K6-166 K6-200 M2	MMX P55C	K6-233



**Warning:** The heat dissipation of Intel PP/MT-233Hz, AMD K6-200/233MHz exceed the original design of this mainboard. Please make sure that you have installed CPU fan properly if Intel PP/MT-233 or AMD K6-200/233 is being selected to use. It may cause your system unstable if you can not meet the heat dissipation requirement from above CPU type. It is recommended to adopt larger fan on these CPU for better air flow in the system.

## Hardware Installation

---

<b>JP8</b>	<b>I/O Voltage (Vio)</b>
1-2	3.45V (default)
3-4	3.52V

**JP8** is reserved for testing purposes only. This jumper enables you to set the voltage of the onboard chipset and PBSRAM (Vio). For dual-voltage CPU, JP8 also functions as CPU I/O voltage (Vcpuio) controller. The default voltage setting is 3.45V.

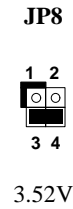
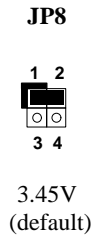
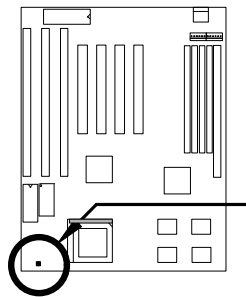

## Hardware Installation

<b>JP9</b>	<b>JP10</b>	<b>JP11</b>	<b>JP12</b>	<b>CPU Type (Vcpuio)</b>
1-2 & 3-4	Open	1-2 & 3-4	Open	Single Voltage CPU Vcpuio = Vcore (default)
Open	1-2 & 3-4	Open	1-2 & 3-4	Dual Voltage CPU Vcpuio = Vio (PP/MT P55C)

Set the jumpers **JP9**, **JP10**, **JP11**, and **JP12** according to the type of CPU currently supported. These jumpers are actually for selecting the CPU I/O voltage (Vcpuio). Normally, for single-voltage CPU such as P54C, AMD K5 and Cyrix 6x86, Vcpuio is equal to Vcore. However, for CPU that needs dual voltage such as PP/MT (P55C) and Cyrix 6x86L, Vcpuio is different from Vcore and must be set to Vio.

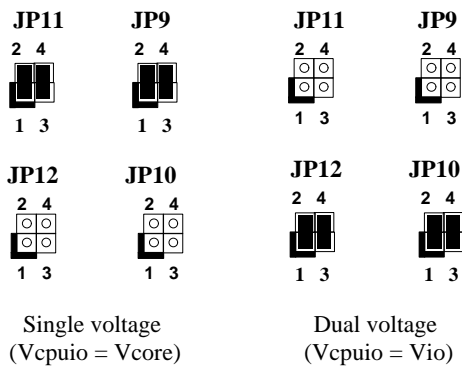
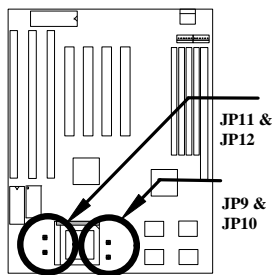

## Hardware Installation

CPU Type	Vcore	Vio	Vcpuio	JP7	JP8	JP9	JP10	JP11	JP12
Intel P54C	3.45V	3.45V	Vcore	1-2	1-2	1-2, 3-4	Open	1-2, 3-4	Open
Intel MMX (P55C)	2.8V	3.45V	Vio	7-8	1-2	Open	1-2, 3-4	Open	1-2, 3-4
AMD K5 (Single voltage)	3.52V	3.45V	Vcore	3-4	1-2	1-2, 3-4	Open	1-2, 3-4	Open
AMD K6-166/200	2.9V	3.45V	Vio	5-6	1-2	Open	1-2, 3-4	Open	1-2, 3-4
AMD K6-233	3.2V	3.45V	Vio	9-10	1-2	Open	1-2, 3-4	Open	1-2, 3-4
Cyrix 6x86	3.52V	3.45V	Vcore	3-4	1-2	1-2, 3-4	Open	1-2, 3-4	Open
Cyrix 6x86L	2.8V	3.45V	Vio	7-8	1-2	Open	1-2, 3-4	Open	1-2, 3-4
Cyrix M2	2.9V	3.45V	Vio	5-6	1-2	Open	1-2, 3-4	Open	1-2, 3-4
IDT C6	3.45V	3.45V	Vcore	1-2	1-2	1-2, 3-4	Open	1-2, 3-4	Open



**Caution:** The above table lists the possible settings only for the current CPUs on the market. The settings may vary in case there is a new CPU product introduced in the market. See your CPU specifications for details.

## Hardware Installation

### 2.2.2 Selecting the CPU Frequency

<u>JP1</u>	<u>JP2</u>	<u>CPU Frequency Ratio</u>
1-2	1-2	1.5x (3.5x)
2-3	1-2	2x
2-3	2-3	2.5x (1.75x)
1-2	2-3	3x

The Intel Pentium, Cyrix 6x86 and AMD K5/K6 CPUs have different internal (Core) and external (Bus) frequency. The ratio of Core/Bus frequency that the CPU uses to multiply the external clock and produce internal frequency is selected by setting **JP1** and **JP2**.

$$\text{Core frequency} = \text{Ratio} \times \text{External bus clock}$$

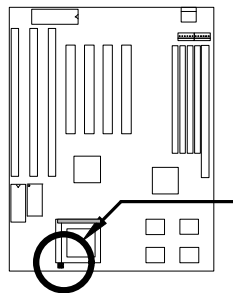

**JP1 & JP2**

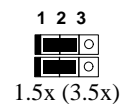

**JP1 & JP2**

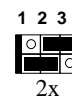

**JP1 & JP2**

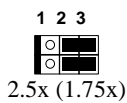

**JP1 & JP2**



**Note:** Intel PP/MT MMX 233MHz is using 1.5x jumper setting for 3.5x frequency ratio, and AMD PR166 is using 2.5x setting for 1.75x frequency ratio.

<u>JP3</u>	<u>JP4</u>	<u>CPU External Clock</u>
2-3	2-3	50MHz
1-2	2-3	60MHz
2-3	1-2	66MHz

**JP3** and **JP4** let you set the CPU external clock (bus clock), i.e., the clock generator frequency.

## Hardware Installation

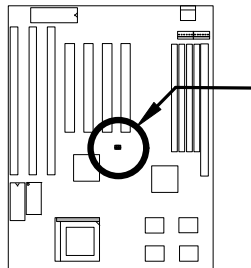

**JP3 & JP4**



**JP3 & JP4**



**JP3 & JP4**



**Caution:** The below table lists the possible settings only for the current CPUs on the market. The settings may vary in case there is a new CPU product introduced in the market. See your CPU specifications for details.

Intel Pentium	CPU Core Frequency	Ratio	External Bus Clock	JP1 & JP2	JP3 & JP4
P54C 75	75MHz =	1.5x	50MHz	1-2 & 1-2	2-3 & 2-3
P54C 90	90MHz =	1.5x	60MHz	1-2 & 1-2	1-2 & 2-3
P54C 100	100MHz =	1.5x	66MHz	1-2 & 1-2	2-3 & 1-2
P54C 120	120MHz =	2x	60MHz	2-3 & 1-2	1-2 & 2-3
P54C 133	133MHz =	2x	66MHz	2-3 & 1-2	2-3 & 1-2
P54C 150	150MHz =	2.5x	60MHz	2-3 & 2-3	1-2 & 2-3
P54C 166	166MHz =	2.5x	66MHz	2-3 & 2-3	2-3 & 1-2
P54C 200	200MHz =	3x	66MHz	1-2 & 2-3	2-3 & 1-2

Intel Pentium P55C	CPU Core Frequency	Ratio	External Bus Clock	JP1 & JP2	JP3 & JP4
PP/MT 150	150MHz =	2.5x	60MHz	2-3 & 2-3	1-2 & 2-3
PP/MT 166	166MHz =	2.5x	66MHz	2-3 & 2-3	2-3 & 1-2
PP/MT 200	200MHz =	3x	66MHz	1-2 & 2-3	2-3 & 1-2
PP/MT 233	233MHz =	3.5x	66MHz	1-2 & 1-2	2-3 & 1-2

IDT C6	CPU Core Frequency	Ratio	External Bus Clock	JP1 & JP2	JP3 & JP4
WinChip 180	180MHz =	3x	60MHz	1-2 & 2-3	1-2 & 2-3
WinChip 200	200MHz =	3x	66MHz	1-2 & 2-3	2-3 & 1-2



## Hardware Installation

Cyrix 6x86	CPU Core Frequency	Ratio	External Bus Clock	JP1 & JP2	JP3 & JP4
P120+	100MHz =	2x	50MHz	2-3 & 1-2	2-3 & 2-3
P150+	120MHz =	2x	60MHz	2-3 & 1-2	1-2 & 2-3
P166+	133MHz =	2x	66MHz	2-3 & 1-2	2-3 & 1-2

Cyrix M2	CPU Core Frequency	Ratio	External Bus Clock	JP1 & JP2	JP3 & JP4
MX-PR166	150MHz =	2.5x	60MHz	2-3 & 2-3	1-2 & 2-3
MX-PR200	166MHz =	2.5x	66MHz	2-3 & 2-3	2-3 & 1-2
MX-PR233	200MHz =	3x	66MHz	1-2 & 2-3	2-3 & 1-2
MX-PR266	233MHz =	3.5x	66MHz	1-2 & 1-2	2-3 & 1-2

AMD K5	CPU Core Frequency	Ratio	External Bus Clock	JP1 & JP2	JP3 & JP4
PR90	90MHz =	1.5x	60MHz	1-2 & 1-2	1-2 & 2-3
PR100	100MHz =	1.5x	66MHz	1-2 & 1-2	2-3 & 1-2
PR120	90MHz =	1.5x	60MHz	1-2 & 1-2	1-2 & 2-3
PR133	100MHz =	1.5x	66MHz	1-2 & 1-2	2-3 & 1-2
PR166	116MHz =	1.75x	66MHz	2-3 & 2-3	2-3 & 1-2

AMD K6	CPU Core Frequency	Ratio	External Bus Clock	JP1 & JP2	JP3 & JP4
PR2-166	166MHz =	2.5x	66MHz	2-3 & 2-3	2-3 & 1-2
PR2-200	200MHz =	3x	66MHz	1-2 & 2-3	2-3 & 1-2
PR2-233	233MHz =	3.5x	66MHz	1-2 & 1-2	2-3 & 1-2



**Notes:** The Cyrix 6x86 and AMD K5 CPUs use P-rating for the reference of CPU benchmark. Unlike the Intel P54C, their internal core frequency is not exactly equal to P-rating marked on the CPU. For example, the AMD PR133 frequency is 100MHz, but its performance is almost equal to Intel P54C 133MHz.

The Intel VX chipset does not support CPU with 55MHz and 75MHz external bus clock; thus, this motherboard cannot support Cyrix P133+ and C6-150.

## Hardware Installation

### 2.2.3 Disabling the Onboard Super I/O Controller

<b>JP18</b>	<b>Onboard Super I/O</b>
1-2	Enabled (default)
2-3	Disabled

The board is default by the manufacturer to enable the onboard Super I/O controller. In case you wish to use an external I/O controller, you need to disable the onboard I/O before the external I/O card functions. To disable, set jumper **JP18** to 2-3.

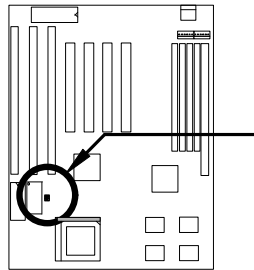

**JP18**



Enabled  
(default)

**JP18**



Disabled

## Hardware Installation

### 2.2.4 Disabling the PS/2 Mouse Function

<b>JP20</b>	<b>PS/2 Mouse</b>
1-2	Enabled (default)
2-3	Disabled

The PS/2 mouse function is normally enabled and occupies IRQ12. To reassign IRQ12 to another function, disable the PS/2 mouse function by setting jumper **JP20** to 2-3.

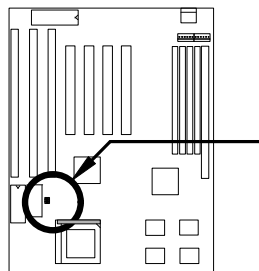

**JP20**



Enabled  
(default)

**JP20**



Disabled

## Hardware Installation

### 2.2.5 Clearing the CMOS

<b>JP14</b>	<b>Clear CMOS</b>
1-2	Normal operation (default)
2-3	Clear CMOS

You need to clear the CMOS if you forget your system password. To clear the CMOS, do the steps that follow the figure below.



*Before you proceed, check your onboard CMOS chip. The “clearing” procedures vary depending on the CMOS chip type. Read the CMOS chip label to determine the chip type.*

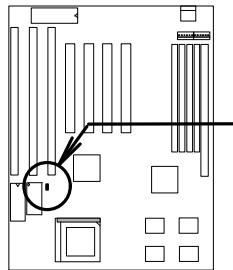

**JP14**



Normal Operation  
(default)

**JP14**



Clear CMOS

#### For Dallas DS12887A:

1. Turn off the system power.
2. Locate **JP14** and short pins 2-3 for a few seconds. Check your manual for the correct jumper settings and location of the jumpers.
3. Reset JP14 to its normal setting by shorting pins 1-2.
4. Turn on the system power.
5. Press **[DEL]** during bootup to enter the BIOS Setup Utility and specify a new password, if needed.

## Hardware Installation

### For Dallas DS12B887, BENCHMARK bq3287AMT, or SGS ST M48T86 PCI chip:

1. Turn off the system power.
2. Locate **JP14** and short pins 2-3 for a few seconds. Check your manual for the correct jumper settings and location of the jumpers.
3. Turn on the system power.
4. Turn off the system power again.
5. Reset **JP14** to its normal setting by shorting pins 1-2.

### 2.2.6 Selecting the DIMM Type

<u>JP25</u>	<u>Memory Type</u>
Open	SDRAM
1-2 & 3-4	EDO

**JP25** lets you select your DIMM chip type. The options are EDO or SDRAM.

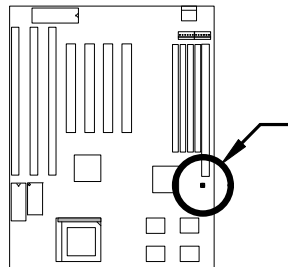

**JP25**



SDRAM

**JP25**



EDO

## Hardware Installation

---

### 2.3 Connectors

#### 2.3.1 Power Cable

A standard baby AT (PS/2) power supply has two cables with six wires on each cable. Plug in these cables to the onboard power connector in such a way that all the black wires are in the center. The power connector is marked **PWR1** on the mainboard.



**Caution:** Make sure that the power supply is OFF before connecting or disconnecting the power cable.

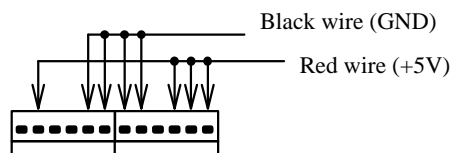
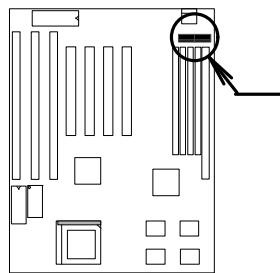

**PWR1**

## Hardware Installation

### 2.3.2 CPU Fan

The fan connector is marked **FAN** on the system board. Plug in the fan cable to this 2-pin connector onboard. Attach the heatsink and fan to the CPU. Check its orientation, make sure the air flow go through the heatsink.

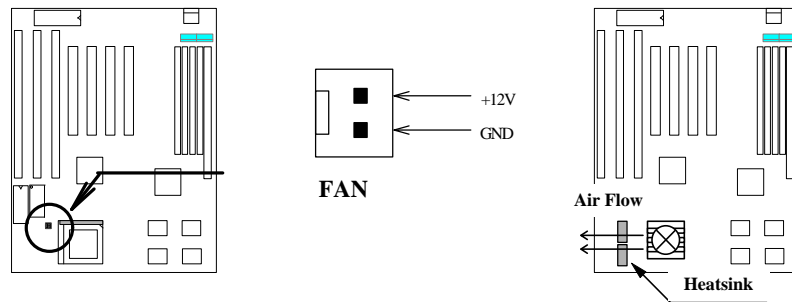

### 2.3.3 PS/2 Mouse

Insert a PS/2 bracket connector to the connector marked **PS2 MS** on the mainboard. Then plug in the PS/2 mouse cable to the mouse port on the bracket.

<u>Pin</u>	<u>Description</u>
1	MS DATA
2	NC
3	GND
4	+5V
5	MS CLK
6	NC

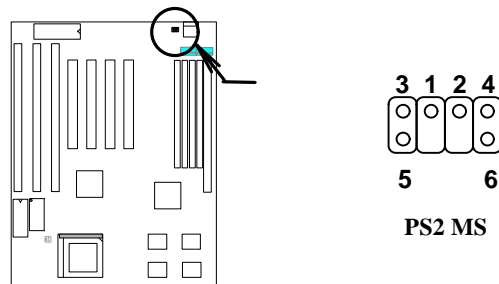

## Hardware Installation

---

### 2.3.4 Serial Devices (COM1/COM2)

Plug in the 10-pin flat cable to the appropriate onboard connectors. The COM1 connector is marked **COM1** and the COM2 connector is marked **COM2** on the mainboard. Then insert the serial device connector into the serial port on the bracket.

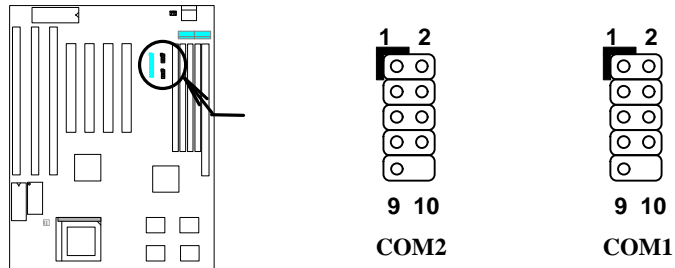



## Hardware Installation

### 2.3.5 USB Device (optional)

You need a USB bracket to enable your system to support additional USB device(s). To attach a USB bracket, simply insert the bracket cable to the onboard connector marked **USB**.

<u>Pin</u>	<u>Description</u>	<u>Pin</u>	<u>Description</u>
1	V0	2	V1
3	D0-	4	D1-
5	D0+	6	D1+
7	GND	8	GND
9	NC	10	NC

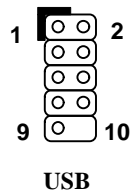
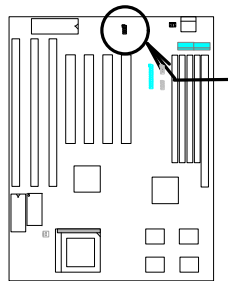

## Hardware Installation

---

### 2.3.6 Floppy Drive

To support a floppy drive, connect the 34-pin floppy drive cable to the floppy drive connector marked **FDC1** on the mainboard.

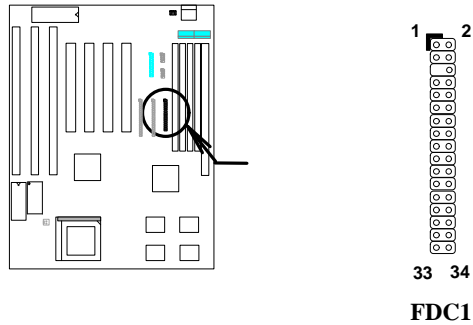

### 2.3.7 Printer

This connector allows you to install a printer to your system. To install, plug in the 26-pin printer flat cable to the onboard parallel connector marked **PRINTER**.

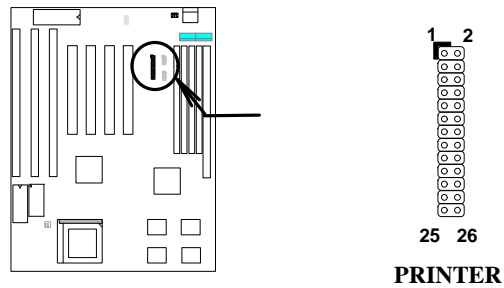

## Hardware Installation

### 2.3.8 IDE Hard Disk and CD ROM

This mainboard supports two 40-pin IDE connectors marked as **IDE1** and **IDE2**. The IDE1 is also known as primary channel and IDE2 as secondary channel. Each channel supports two IDE devices.

In order to enable the devices to work together, the two devices on each channel must be set differently to master and slave mode. The device can either be a hard disk or a CD-ROM. The setting of master or slave depends on your IDE device jumper. See to your hard disk and CD-ROM manual.

To attach the IDE devices, connect your first IDE hard disk to master mode of the primary channel. If you have second IDE device to install in your system, connect it as slave mode on the same channel. The third and fourth devices, if any, can be connected on secondary channel at master and slave respectively.

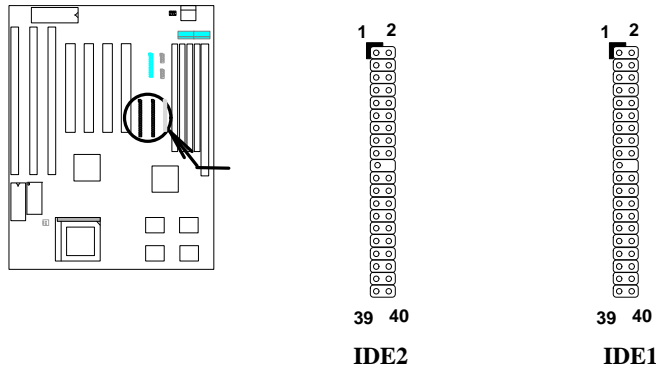

**Caution:** The maximum specification of the IDE cable is 46cm (18 inches). Make sure that your cable does not exceed this length.

For better signal quality, we recommend that you set the device connected to the end of the cable master mode. Follow the suggested sequence to install your new device (see the following figure).

## Hardware Installation

---

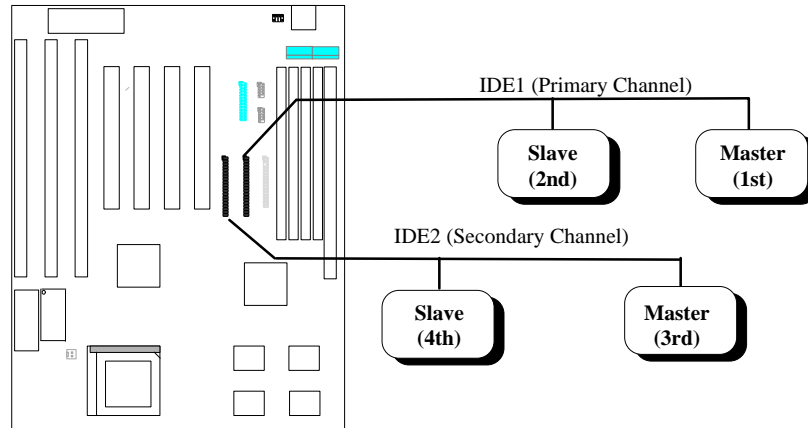

## Hardware Installation

### 2.3.9 Hard Disk LED

The HDD LED connector is marked **HDD LED** on the board. This connector is designed to support various types of housing. Actually, only two pins are necessary for the LED. If your housing comes with a 4-pin connector, simply attach it to the onboard connector. For a 2-pin connector, you can insert it to pins 1-2 or pins 3-4. However, when connecting, take note of the polarity of the pins.

<u>Pin</u>	<u>Description</u>
1	HDD LED
2	GND
3	GND
4	HDD LED

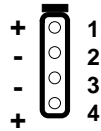
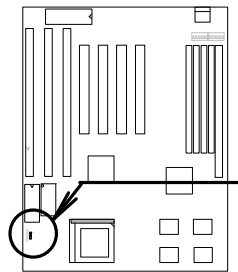

**HDD LED**

4-pin connector

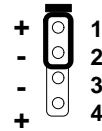

**HDD LED**

2-pin connector  
at pin 1-2

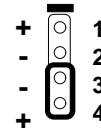

**HDD LED**

2-pin connector  
at pin 3-4



## Hardware Installation

---



**Notes:** *If your housing comes with Turbo switch and Turbo LED connectors, you may use these connectors for Suspend switch and Green mode LED functions, respectively.*

*Pressing the Suspend switch allows you to manually set the system to suspend mode. However, this is possible only if the Power Management function in the BIOS Setup menu is enabled.*

## Hardware Installation

---

### 2.3.11 Keyboard

The onboard keyboard connector is a 5-pin AT-compatible connector marked **KB1**. The figure below shows how the keyboard connector as viewed from the back panel of the housing.



**Note:** The mini DIN PS/2 keyboard connector is optional.

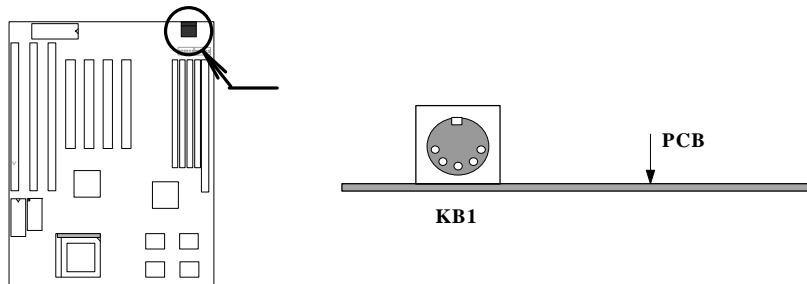



## Hardware Installation

### 2.3.12 IrDA Connector

Serial port 2 can be configured to support wireless infrared module via this connector and application software such as Laplink. This module enables the user to transfer files to or from laptops, notebooks, PDA and printers without using cables. This mainboard supports IrDA (115Kbps, 1 meter), as well as ASK-IR (19.2Kbps).

To install an infrared module, insert the module cable to **IrDA** connector then enable infrared function by BIOS setup. Make sure of the correct cable orientation when connecting the cable to the IrDA connector.

<u>Pin</u>	<u>Description</u>
1	+5V
2	NC
3	IRRX
4	GND
5	IRTX
6	+3.3V

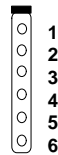
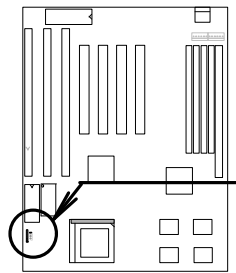

**IrDA**

## Hardware Installation

### 2.4 Configuring the System Memory

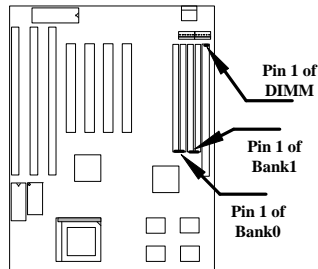

This mainboard has four 72 pin SIMM sockets (Single-in-line Memory Module) and one 168 pin DIMM socket (Dual-in-line Memory Module) that allow you to install system memory from minimum 8MB up to maximum 128MB.

The SIMM supported by this mainboard can be identified by 4 kinds of factors, Intel VX chipset does not support 64M bit technology.

- ◆ Size: single side, 1Mx32 (4MB), 4Mx32 (16MB), and double side, 1Mx32x2 (8MB), 4Mx32x2 (32MB).
- ◆ Speed: 60ns or 70ns access time
- ◆ Type: FPM (Fast page mode) or EDO (Extended data output)
- ◆ Parity: without parity (32 bit wide)

The DIMM supported by this motherboard are always 64-bit wide SDRAM, which can be identified by following factors:

- I. **Size:** single side, 1Mx64 (8MB), 2Mx64 (16MB), 4Mx64 (32MB), 8Mx64 (64MB), 16Mx64 (128MB), and double side, 1Mx64x2 (16MB), 2Mx64x2 (32MB), 4Mx64x2 (64MB), 8Mx64x2 (128MB).



**Tip:** Here is a trick to check if your DIMM is single-side or double-side -- if there are traces connected to golden finger pin 114 and pin 129 of the DIMM, the DIMM is probably double-side; otherwise, it is single-side. Following figure is for your reference.

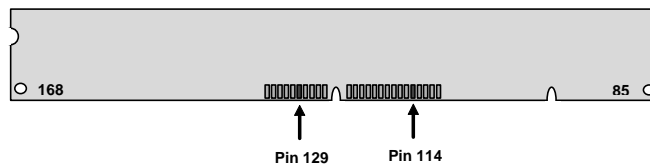

## Hardware Installation

- II. Speed:** normally marked as as -12, which means the clock cycle time is 12ns and maximum clock of this SDRAM is 83MHz. Sometimes you can also find the SDRAM marked as -67, which means maximum clock is 67MHz.
- III. Buffered and non-buffered:** This motherboard supports non-buffered DIMMs. You can identify non-buffered DIMMs and buffered DIMMs according to the position of the notch, following figure is for your reference:

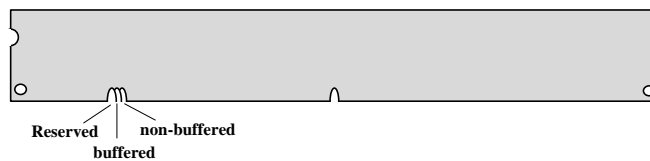

Because the positions are different, only non-buffered DIMMs can be inserted into the DIMM sockets on this motherboard. Although most of DIMMs on current market are non-buffered, we still recommend you to ask your dealer for the correct type.

- IV. 2-clock and 4-clock signals:** Although both of 2-clock and 4-clock signals are supported by AP5VM, we strongly recommend you to choose 4-clock SDRAM in consideration of reliability.



**Tip:** To identify 2-clock and 4-clock SDRAM, you may check if there are traces connected to golden finger pin 79 and pin 163 of the SDRAM. If there are traces, the SDRAM is probably 4-clock; Otherwise, it is 2-clock.

- V. Parity:** This motherboard supports standard 64 bit wide (without parity) SDRAM.

Because Pentium processor has 64 bit bus width, the four SIMM sockets are arranged in two banks of two sockets each, they are Bank0 and Bank1. Both SIMMs in each bank must be in the same size and type. It is allowed to have different speed and type in different bank, for example, 70ns FPM in one bank and 60ns EDO in another bank, in such case, each bank is independently optimized for maximum performance. The memory timing requires at least 70ns fast page mode DRAM chip, but for optimum performance, 60ns EDO DRAM is recommended.

## Hardware Installation



**Warning:** The default memory timing setting is 60ns to obtain the optimal performance. Because of the specification limitation, 70ns SIMM is recommended to be used only for CPU external clock 60MHz.



**Tip:** EDO DRAM is designed to improve the DRAM read performance. Unlike traditional fast page mode, that tri-states the memory output data to start the precharge activity, EDO DRAM holds the memory data valid until the next memory access cycle, which is similar to pipeline effect and reduces one clock state.

There is no jumper setting required for the memory size or type. It is automatically detected by the system BIOS. You can use any single side SIMM and DIMM combination list below for BANK0/BANK1 or DIMM socket, and the total memory size is to add them together. **But because of chipset limitation, the maximum is only 128MB.**

SIMM1	SIMM2	Subtotal of Bank0
None	None	0MB
4MB	4MB	8MB
8MB	8MB	16MB
16MB	16MB	32MB

SIMM3	SIMM4	Subtotal of Bank1
None	None	0MB
4MB	4MB	8MB
8MB	8MB	16MB
16MB	16MB	32MB

DIMM1	Size of DIMM Socket
None	0MB
8MB	8MB
16MB	16MB
32MB	32MB

**Total Memory Size = Subtotal of Bank0 + Subtotal of Bank1  
+ Size of DIMM socket**

## Hardware Installation

For double side memory module, there is one limitation. This mainboard supports only 4 RAS# (Row address latch) signals for DRAM control. They can only be occupied by one DRAM module, they can not be shared. **The simple rule is: If double side module at either Bank1 or DIMM, the other must be empty.** Bank0 has no such limitation.

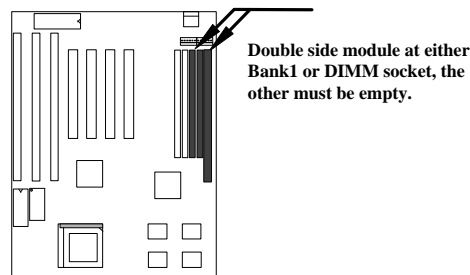

Following table explains more about the RAS limitation. You can see that Bank1 1st side and DIMM 2nd side use the same RAS2#, and Bank1 2nd side and DIMM 1st side use the same RAS3#. If you are using single side SIMM at Bank1 and single side DIMM, it should be no problem. But if you are using double side DIMM or double side SIMM at Bank1, the other must be empty.

	Bank0 1st side	Bank0 2nd side	Bank1 1st side	Bank1 2nd side	DIMM 1st side	DIMM 2nd side
RAS0#	X					
RAS1#		X				
RAS2#			X			X
RAS3#				X	X	



**Caution:** Make sure that you install the same SIMM type and size for each bank.

**Caution:** There are some old DIMMs made by EDO or FPM memory chip, they can only accept 5V power and probably can not fit into the DIMM socket, make sure you have 3.3V true SDRAM DIMM before your insert it.

## Hardware Installation



**Warning:** Do not use SIMM and SDRAM DIMM together unless you have 5V tolerance SDRAM (such as Samsung or TI). The FPM/EDO operate at 5V while SDRAM operates at 3.3V. If you combine them together the system will temporary work fine; however after a few months, the SDRAM 3.3V data input will be damaged by 5V FPM/EDO data output line.

There is an important parameter affects SDRAM performance, CAS Latency Time. It is similar as CAS Access Time of EDO DRAM and is calculated as number of clock state. The SDRAM that AOpen had tested are listed below. If your SDRAM has unstable problem, go into BIOS "Chipset Features Setup", change CAS Latency Time to 3 clocks.

Manufacturer	Model	Suggested CAS Latency Time	5V Tolerance
Samsung	KM416511220AT-G12	2	Yes
NEC	D4S16162G5-A12-7JF	2	No
Hitachi	HMS216805TT10	2	No
TI	TMX626812DGE-12	2	Yes
TI	TMS626812DGE-15	3	Yes
TI	TMS626162DGE-15	3	Yes
TI	TMS626162DGE-M67	3	Yes

The driving capability of new generation chipset is limited because the lack of memory buffer (to improve performance). This makes DRAM chip count an important factor to be taking into consideration when you install SIMM/DIMM. Unfortunately, there is no way that BIOS can identified the correct chip count, you need to calculate the chip count by yourself. The simple rule is: By visual inspection, use only SIMM with chip count less than 24 chips, and use only DIMM which is less than 16 chips.



**Warning:** Do not install any SIMM that contains more than 24 chips. SIMMs contain more than 24 chips exceed the chipset driving specification. Doing so may result in unstable system behavior.

**Warning:** Due to loading issue, it is not recommended to use x4 (bit) SDRAM chip.

## Hardware Installation



**Tip:** The SIMM/DIMM chip count can be calculated by following example:

1. For 32 bit non-parity SIMM using 1M by 4 bit DRAM chip,  $32/4=8$  chips.
2. For 36 bit parity SIMM using 1M by 4 bit DRAM chip,  $36/4=9$  chips.
3. For 36 bit parity SIMM using 1M by 4 bit and 1M by 1 bit DRAM, the chip count will be 8 data chips( $32/4$ ) plus 4 parity chips( $4=4/1$ ), total is 12 chips.
4. For 64 bit DIMM using 1M by 16 bit SDRAM, the chip count is  $64/16=4$  chips.

Following table list the recommended DRAM combinations of SIMM and DIMM:

SIMM Data chip	SIMM Parity chip	Bit size per side	Single/ Double side	Chip count	SIMM size	Recommended
1M by 4	None	1Mx32	x1	8	4MB	Yes
1M by 4	None	1Mx32	x2	16	8MB	Yes
1M by 4	1M by 1	1Mx36	x1	12	4MB	Yes
1M by 4	1M by 4	1Mx36	x1	9	4MB	Yes
1M by 4	1M by 4	1Mx36	x2	18	8MB	Yes
1M by 16	None	1Mx32	x1	2	4MB	Yes
1M by 16	None	1Mx32	x2	4	8MB	Yes
1M by 16	1M by 4	1Mx36	x1	3	4MB	Yes
1M by 16	1M by 4	1Mx36	x2	6	8MB	Yes
4M by 4	None	4Mx32	x1	8	16MB	Yes
4M by 4	None	4Mx32	x2	16	32MB	Yes
4M by 4	4M by 1	4Mx36	x1	12	16MB	Yes
4M by 4	4M by 1	4Mx36	x2	24	32MB	Yes

## Hardware Installation

DIMM Data chip	Bit size per side	Single/Double side	Chip count	DIMM size	Recommended
1M by 16	1Mx64	x1	4	8MB	Yes
1M by 16	1Mx64	x2	8	16MB	Yes
2M by 8	2Mx64	x1	8	16MB	Yes
2M by 8	2Mx64	x2	16	32MB	Yes



**Tip:** 8 bit = 1 byte, 32 bit = 4 byte. The SIMM size is represented by number of data byte (whether with or without parity), for example, the size of single side SIMM using 1M by 4 bit chip is 1Mx32 bit, that is, 1M x 4 byte = 4MB. For double side SIMM, simply multiply it by 2, that is, 8MB.

Following table are possible DRAM combinations that is **NOT** recommended:

SIMM Data chip	SIMM Parity chip	Bit size per side	Single/Double side	Chip count	SIMM size	Recommended
1M by 1	None	1Mx32	x1	32	4MB	No
1M by 1	1M by 1	1Mx36	x1	36	4MB	No
1M by 4	1M by 1	1Mx36	x2	24	8MB	No
4M by 1	None	4Mx32	x1	32	16MB	No
4M by 1	4M by 1	4Mx36	x1	36	16MB	No

DIMM Data chip	Bit size per side	Single/Double side	Chip count	DIMM size	Recommended
4M by 4	4Mx64	x1	16	32MB	No
4M by 4	4Mx64	x2	32	64MB	No



# Chapter 3

## AMI BIOS

This chapter tells how to configure the system by setting the BIOS parameters.

### 3.1 Entering the AMI BIOS Setup

To enter the AMI BIOS Setup, press **DEL**. The AMI BIOS Setup Main Menu appears as shown below.

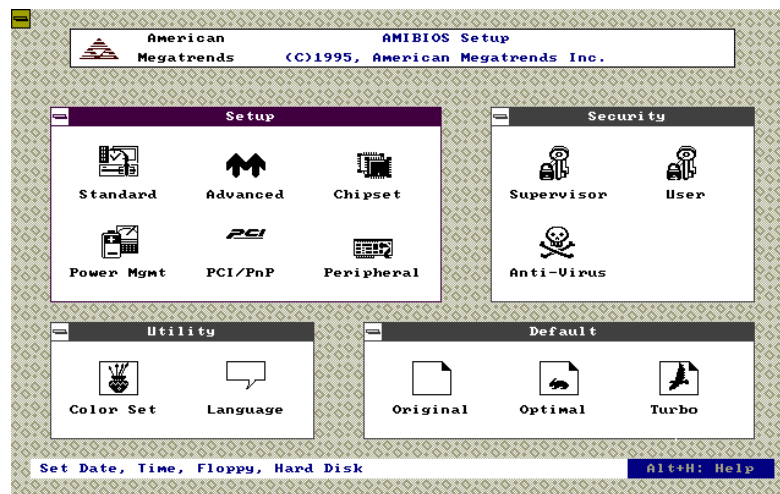

The AMI BIOS is in Windows form. You can use either the keyboard or a mouse to move between the items.

To select among the Setup menu groups, use **F5** to highlight the selected group or simply click on the icon of the selected Setup menu.

To select among the options, you can either use the arrow keys to move the highlight bar or simply click on the icon of the desired option.

## AMI BIOS Utility

---

After making your selection, press **ENTER** or double-click on the icon to open the selected menu option.



You may press **INS** to perform the following:

- *Resolve an address conflict due to an IRQ address assigned to multiple slots. For more information on IRQ assignment, see the section 3.2.3 (Chipset Features Setup).*
- *Return to the BIOS default settings if the PnP BIOS does not recognize the hardware modifications under Windows 95.*

*To meet the PC market demands, ongoing hardware and software enhancements are done on the system. Therefore, it is possible that BIOS screens may be changed without notice.*

### 3.2 Setup Menu

The figure below shows the Setup window. Use the arrow keys to highlight an option.

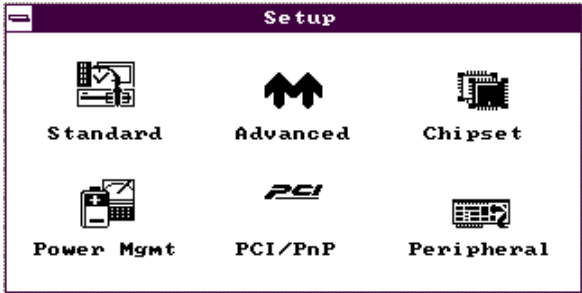

#### 3.2.1 Standard Setup

The following screen appears if you select Standard from the Setup options:

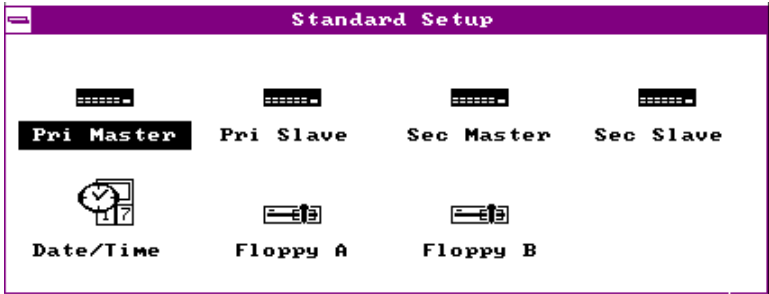

You can input configuration values such as date, time and disk types in this menu.

**PRIMARY MASTER AND SLAVE/  
SECONDARY MASTER AND SLAVE**

These parameters allow you to configure the hard disks and the IDE devices connected to your IDE connectors. To configure the hard disk connected to the master port of the primary IDE connector, select Primary Master and press **ENTER**. The following screen appears:

## AMI BIOS Utility

---

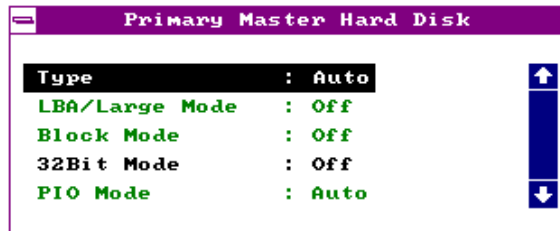

To configure the hard disk connected to the slave port of the primary IDE connector, select Primary Slave.

The secondary IDE connector also supports two IDE devices. To configure the hard disk or the IDE device connected to the master port, select Secondary Master. Choose Secondary Slave to configure the device connected to the slave port.

The following are the parameters that you need to set to configure your hard disks or the IDE devices:

## AMI BIOS Utility

---

### **Type**

This parameter lets you set the IDE device type that your system supports. The options are `User`, `Auto`, `CD-ROM`, `Type 1-46`, and `Not Installed`. Select `Auto` to automatically configure the installed hard disk or IDE device. Select `CD-ROM` if you have a `CD-ROM` installed in your system. If you have an old type HDD installed, you may need to enter the HDD parameters manually. To do this, you must set this parameter to `User`. Select `Not Installed` to bypass the function.

### **LBA/Large Mode**

This enhanced IDE feature allows the system to use a hard disk with a capacity of more than 528 MB. This is made possible through the Logical Block Address (LBA) mode translation. Set the parameter to `Off` to disregard the feature.

This parameter becomes non-configurable when the HDD Type parameter is set to `Auto`.

### **Block Mode**

This function enhances disk performance depending on the hard disk in use. If enabled, it allows data transfers in block (multiple sectors) by increasing the data transfer rate to 256 bytes/cycle. However, if your hard disk does not support this function, set this parameter to `Off`.

This parameter becomes non-configurable when the HDD Type parameter is set to `Auto`.

## AMI BIOS Utility

### 32-bit Mode

Enabling this parameter improves system performance by increasing the hard disk access to 32-bit mode. However, make sure that your hard disk supports this function before you enable the parameter. Otherwise, set this parameter to Off.

### PIO Mode

Setting this parameter to On allows the system to use a faster hard disk drive. If your hard disk does not support the PIO mode feature, set this parameter to Off.

This parameter becomes non-configurable when the HDD Type parameter is set to Auto.

### HARD DISK TYPES

After you have set all the necessary parameters, press **ENTER**. A list of the HDD drive parameters appears:

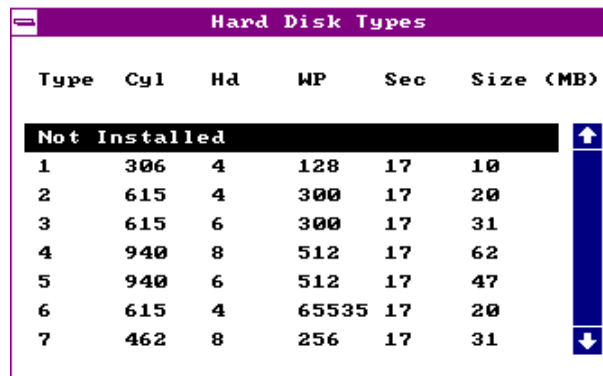

Type	Cyl	Hd	WP	Sec	Size (MB)
Not Installed					
1	306	4	128	17	10
2	615	4	300	17	20
3	615	6	300	17	31
4	940	8	512	17	62
5	940	6	512	17	47
6	615	4	65535	17	20
7	462	8	256	17	31

Select your hard disk type. Press **↑** or **↓** to move among the selections. After you have made your selection, press **ENTER**.

If you cannot find your hard disk drive type on the list, select User. This allows you to enter the disk parameters manually.

### DATE/TIME

To set the date and time, highlight Date/Time and press **ENTER**. The following screen appears:

## AMI BIOS Utility

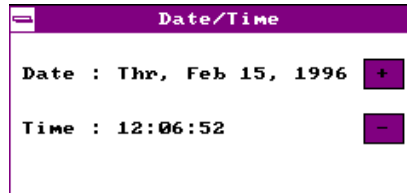

Select the arrow keys to move among the items. Press or click on **+** or **-** to set the current time and date. Press **ENTER** or double-click on the Control menu box at the upper-left corner of the window.

### **FLOPPY DRIVES A AND B**

To configure the first floppy drive, select Floppy A. The following values appear on screen:

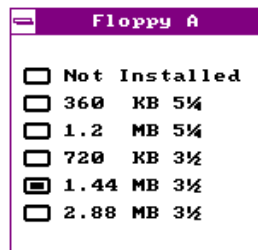

After selecting the proper setting, press **ENTER**.

Select Floppy B and follow the same procedure to configure the second floppy drive.

### **3.2.2 Advanced CMOS Setup**

The following screen appears if you select the option Advanced from the Setup menu:

## AMI BIOS Utility

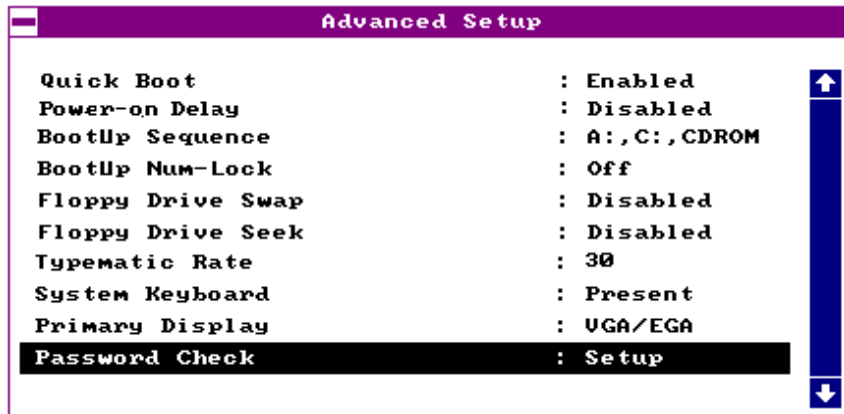

The first screen does not show all the parameters of the Advanced Configuration menu. To scroll down the rest of the parameters, press **[PGDN]**. Press **[↑]** or **[↓]** to highlight the desired parameter.

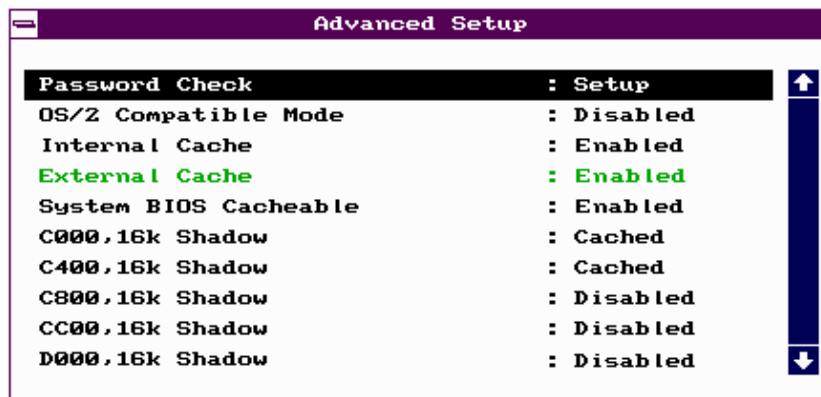



## AMI BIOS Utility

Advanced Setup	
Internal Cache	: Enabled
External Cache	: Enabled
System BIOS Cacheable	: Enabled
C000, 16k Shadow	: Cached
C400, 16k Shadow	: Cached
C800, 16k Shadow	: Disabled
CC00, 16k Shadow	: Disabled
D000, 16k Shadow	: Disabled
D400, 16k Shadow	: Disabled
D800, 16k Shadow	: Disabled
DC00, 16k Shadow	: Disabled



*Do not change the settings of the Advanced Setup parameters if you are not a qualified technician. Doing so may cause fatal system failure.*

### Quick Boot

During boot up, the system performs power-on self test (POST) routines. Enable the parameter if you want to skip some POST routines during the boot process. Set this to **Disabled** to let the system perform all the POST routines and follow the specified boot-up sequence.

### Boot-up Sequence

The boot-up sequence allows you to specify the system search sequence. The selections are **C:**, **A:**, **CD-ROM**, **A:**, **C:**, **CD-ROM** and **CD-ROM**, **A:**, **C:**. If you have a bootable CD-ROM installed, you may set the CD-ROM as the first priority. The default is **A:**, **C:**, **CD-ROM**.

### Boot-up Numlock

Setting this parameter to **On** enables the numeric function of the numeric keypad. Set this parameter to **Off** to disable the function. Disabling the numeric function allows you to use the cursor control numeric keypad. The default setting is **Off**.

## AMI BIOS Utility

---

### **Floppy Drive Swap**

This parameter allows you to swap floppy drives. For example, if you have two floppy drives (A and B), you can assign the first drive as drive B and the second drive as drive A or vice-versa. Disable the parameter to bypass the function. The default is *Disabled*.

### **Floppy Drive Seek**

When enabled, BIOS detects whether there is a floppy disk drive installed in the system. Disable the parameter to skip the function.

### **Typematic Rate**

This parameter allows you to control the speed at which the system registers repeated keystrokes.

### **System Keyboard**

Set this parameter to *Present* if there is a keyboard connected to the system. If none, select *Absent*.

### **Primary Display**

This function specifies the VGA type in use. The selections are *VGA/EGA*, *CGA 40 x 25*, *CGA 80 x 25*, *Mono*, and *Absent*. The default setting is *VGA/EGA*.

### **Password Check**

This parameter lets you set when to check for the password. When set to *Always*, a password prompt appears every time you turn on the computer and when you enter *Setup*. When set to *Setup*, the password prompt appears when you try to enter *setup*. The *Optimal* and *Turbo* default setting is *Setup*.

### **OS/2 Compatible Mode**

Enable the parameter if your system is utilizing an OS/2 operating system and has a memory size of more than 64 MB. Otherwise, set this to *Disabled*. The default setting is *Disabled*.

## AMI BIOS Utility

---

### **Internal Cache**

This function lets you enable or disable the internal cache.

### **External Cache**

This function lets you enable or disable the external cache.

### **System BIOS Cacheable**

Enabling this parameter allows you to cache the system BIOS to further system performance. The default settings is `Enabled`.

### **C000 ~ DC00, 16K Shadow**

These parameters are for shadowing expansion cards with ROM. You need to know the specific addresses that ROMs use to shadow the expansion cards before you set any of these parameters. If you do not know this information, enable all the ROM shadow settings. This ensures shadowing of any present ROMs and reduces the available memory. Select `Cached` if the data in the chosen addresses are already copied into RAM.



*The F000 and E000 addresses are exclusively shadowed for BIOS.*

## AMI BIOS Utility

### 3.2.3 Chipset Features Setup

The Chipset Features Setup controls the board chipset settings. The controls for this menu are the same as for the previous screens. The Chipset Features Setup screen appears as follows.

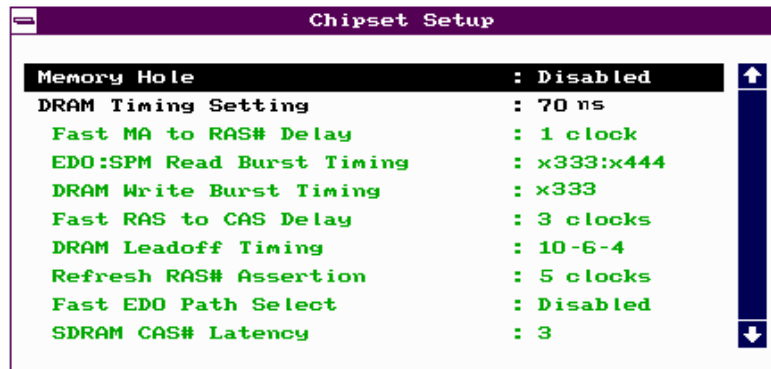

To scroll down the rest of the parameters, press **PGDN**. Use **↑** or **↓** to highlight the desired parameter.

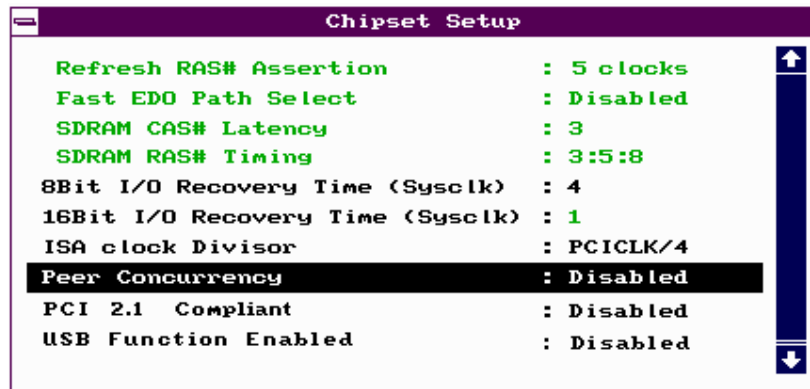

#### Memory Hole

This option lets you assign the system memory area for ISA cards installed in your system to avoid memory conflicts. The available settings are 512~640K, 15~16M and Disabled.

### **DRAM Timing Setting**

The selections for this parameter are 60 ns, 70 ns, and Manual. If you select either 60 ns or 70 ns, the DRAM Timing subparameters become non-configurable since BIOS automatically sets the values. Select Manual if you want to specify your own parameter settings.

#### **FAST MA TO RAS# DELAY**

This option specifies the wait state between the master address (MA) and row address strobe (RAS) signals. The selections are 1 clock and 2 clocks.

#### **EDO:SPM READ BURST TIMING**

This parameter adjusts the read wait state for Extended Data Out (EDO) DRAM and Standard Page Mode (SPM) DRAM. Every time the CPU reads the second-level cache miss, it reads four continuous memory cycles on four continues addresses from the EDO and SPM cache.

The selections for this parameter are x444/X444, X333/X444, X222/X333, and X3222/X333. The value of X depends on the DRAM Lead-off Timing parameter setting.

#### **DRAM WRITE BURST TIMING**

This parameter adjusts the write wait state between the second-level and the DRAM cache. The second-level cache is processed through write-back method and each cache write process consists of four continuous cache write cycles.

The parameter settings are X444, X333, and X222. Faster DRAMs require shorter wait states. The value of X depends on the DRAM Lead-off Timing parameter setting.

#### **FAST RAS TO CAS DELAY**

This option specifies the wait state between the row address strobe (RAS) and column address strobe (CAS) signals. The available settings are 3 clocks and 2 clocks.

#### **DRAM LEAD-OFF TIMING**

This option specifies the DRAM waiting time or the delay before data can be accessed. Some DRAMs may require a longer delay to access data. The selections are 11-7-3, 10-6-3, 11-7-4, and 10-6-4.

## AMI BIOS Utility

---

### **REFRESH RAS# ASSERTION**

This function controls the number of clocks required to assert RAS# for refresh cycles. The available settings are 4 clocks and 5 clocks.

### **FAST EDO PATH SELECT**

Enable this option to select a fast path for CPU to DRAM read cycles to minimize the lead-off time. This is applicable only for EDO DRAMs. For other DRAM types, we recommend that you set this to Disabled.

### **SDRAM CAS# LATENCY**

This parameter controls the wait state between SDRAM row address strobe and SDRAM CAS signals.

### **SDRAM RAS# TIMING**

This parameter controls the RAS# precharge, RAS# active-to-precharge time, and refresh-to-RAS# active signal delay.

### **8-bit I/O Recovery Time (Sysclk)**

This parameter allows you to set the response time of the 8-bit I/O devices connected to your system. The settings range from 1-8 SYSCLK and Disabled.

### **16-bit I/O Recovery Time (Sysclk)**

This parameter allows you to set the response time of the 16-bit I/O devices connected to your system. The settings range from 1-4 SYSCLK and Disabled.

### **ISA Clock Divisor**

This option specifies the ISA bus clock divisor. The selections are PCICLK/4 and PCICLK/3.

### **Peer Concurrency**

Enable the parameter to allow the CPU to run secondary DRAM PCI master cycles to target PCI peer devices. Select Disabled to hold the CPU bus. The default setting is Disabled.

## AMI BIOS Utility

---

### PCI 2.1 Compliant

This parameter lets you enable or disable the PIIX3 PCI register passive release functions. When enabled, the PIIX3 controls the USB operation to make sure that the system complies with the PCI Revision 2.1 specification. Select `Disabled` to disregard the functions.

### USB Function Enabled

This parameter lets you enable or disable the USB device(s) connected to your system, if any. The default is `Disabled`.



*The USB function shares INTD with PCI slot 4. Therefore, if you enable the USB function, only PCI cards that do not require IRQ, such as VGA, can be installed in slot 4. The PnP BIOS assigns an IRQ to VGA if the VGA requests for it.*

## AMI BIOS Utility

### 3.2.4 Power Management Setup

To take advantage of the power-management feature, select Power Management from the Setup menu. The following screen appears:

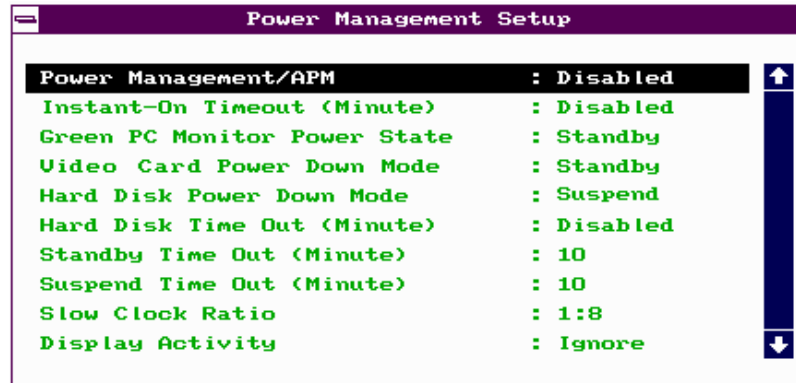

To scroll down the rest of the parameters, press **[PGDN]**. Use **[↑]** or **[↓]** to highlight the desired parameter.

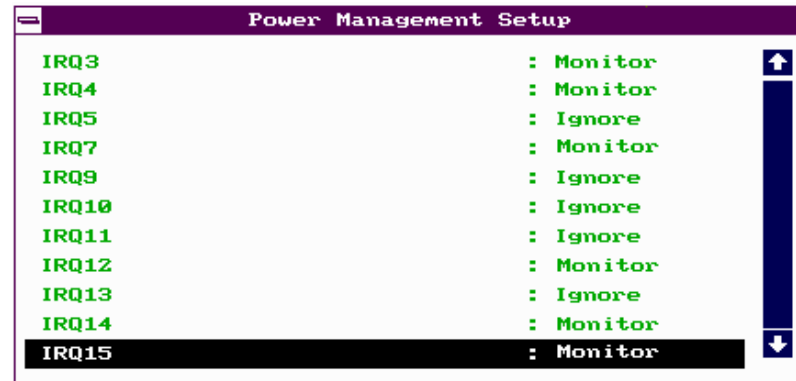

#### Power Management/APM

This parameter enables or disables the advanced power-management function.



### **Instant On Time-out (Minutes)**

This parameter is configurable only if the Power Management/APM parameter is set to `Instant On`. This option lets you specify when to resume system power after being in power-saving mode for a certain period of time.

### **Green Monitor Power-down State**

This function lets you set when to power down your green PC monitor. The options are `Standby`, `Suspend`, and `Off`. The default is `Standby`.

### **Video Card Power-down Mode**

This option allows you to set when to power down your system display card. The card function returns to full power once the system resumes to normal mode. The selections are `Standby`, `Suspend`, and `Disabled`. The default setting is `Standby`.

### **Hard Disk Power-down Mode**

This option lets you set when to “spin down your IDE hard disk. The disk returns to full speed once the system resumes to normal mode. The available settings are `Standby`, `Suspend`, and `Disabled`. The default setting is `Suspend`.

### **Hard Disk Time-out (Minutes)**

This option lets you specify when to set the hard disk to the specified power-down mode. The settings range from `1 ~ 15 Minutes` and `Disabled`.

### **Standby Time-out (Minutes)**

This function lets you set when to put the system into standby mode. In standby mode, the CPU clock slows down. Any event detected returns the system to full power. The settings range from `1 ~ 15 Minutes` and `Disabled`.

### **Suspend Time-out (Minutes)**

This function lets you set when to put the system into suspend mode. In suspend mode, the CPU clock stops. Any event detected returns the system to full power. The settings range from `1 ~15 Minutes` and `Disabled`.

## AMI BIOS Utility

---

### **Slow Clock Ratio**

When the system enters the standby mode, the CPU clock starts to slow down. This parameter lets you set the “slow down” clock ratio. The selections are from 1:1, 1:2, 1:4, 1:8, 1:16, 1:32, 1:64, and 1:128.

### **Display Activity**

This function lets you check the activity of the monitor. When set to `Monitor`, any detected activity from the display resumes the system to normal mode. When set to `Ignore`, the power management function bypasses the display activities detected.

### **IRQ 3, 4, 5, 7, 9, 10, 11, 12, 13, 14, and 15**

These parameters enable or disable specific I/O devices as wake up events in the power management mode. Any activity detected from the enabled IRQs resets the power-management timers and returns the system to normal mode.

### 3.2.5 PCI/PnP Setup

The PCI/PnP Setup allows you to specify the setting for your PCI devices. The screen below appears on screen if you select PCI/PnP from the Setup menu.

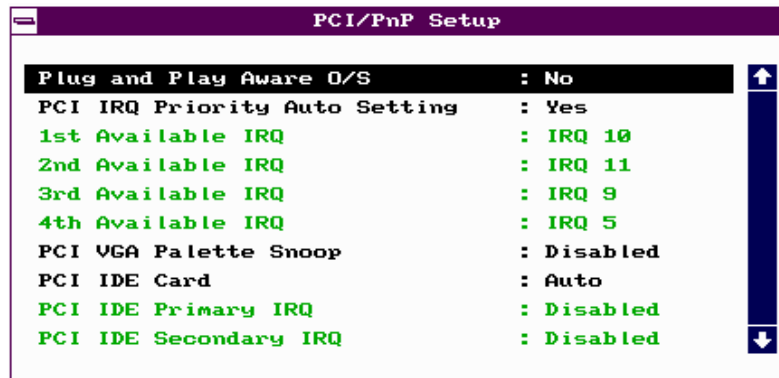

To scroll down the rest of the parameters, press **PGDN**. Use **↑** or **↓** to highlight the desired parameter.

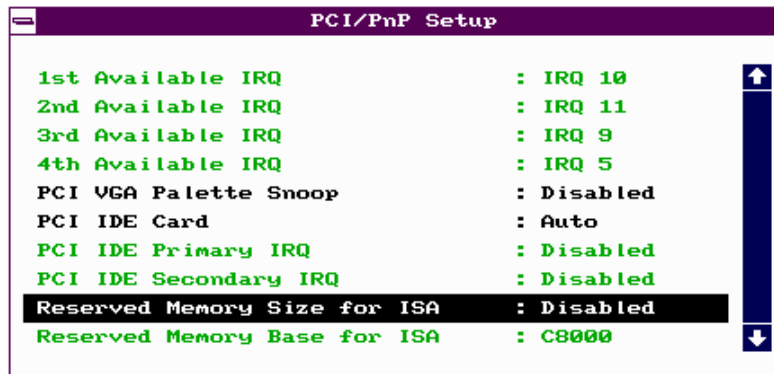

#### Plug-and-Play Aware O/S

Enable this parameter only if you have a Plug-and-Play operating system, such as Windows 95.

## AMI BIOS Utility

---

### **PCI IRQ Priority Auto Setting**

Set this parameter to `Yes` to automatically set the appropriate available interrupt for each PCI slot. Select `No` if you prefer to manually set the interrupts.

### **1st, 2nd, 3rd, and 4th Available IRQ**

These parameters are configurable only if the PCI IRQ Priority Auto Setting parameter is set to `No`. When configurable, these let you specify the ranking of the interrupts which you can assign to the PCI devices installed in your system.

### **PCI VGA Palette Snoop**

PCI devices support the palette snooping technique that enables the device to control access to their palette registers. Enable this parameter to activate the palette snooping function in the PCI VGA devices installed in the system. Check your VGA card manual for more information about this function. The default setting is `Disabled`.

### **PCI IDE Card**

This function allows you to select the PCI slot(s) that you want to enable, if there is any offboard PCI IDE card present. Set this parameter to `Auto` to automatically configure the installed PCI card.

### **PCI IDE Primary IRQ**

This parameter lets you assign an IRQ for the IDE device connected to your primary IDE connector. The options are `INTA`, `INTB`, `INTC`, `INTD`, `Hardwired` and `Disabled`. If the PCI IDE Card parameter is set to `Auto`, this parameter becomes non-configurable.

### **PCI IDE Secondary IRQ**

This parameter lets you assign an IRQ for the IDE device connected to your secondary IDE connector. The options are `INTA`, `INTB`, `INTC`, `INTD`, `Hardwired` and `Disabled`. If the PCI IDE Card parameter is set to `Auto`, this parameter becomes non-configurable.

## AMI BIOS Utility

---

### **Reserved Memory Size for ISA**

This option lets you specify the memory area reserved for Legacy/ISA devices.

### **Reserved Memory Base for ISA**

This option lets you specify the memory base address reserved for Legacy/ISA devices.

## AMI BIOS Utility

---

### 3.2.6 Peripheral Setup

Select **Peripheral** from the Setup menu and the following screen appears.

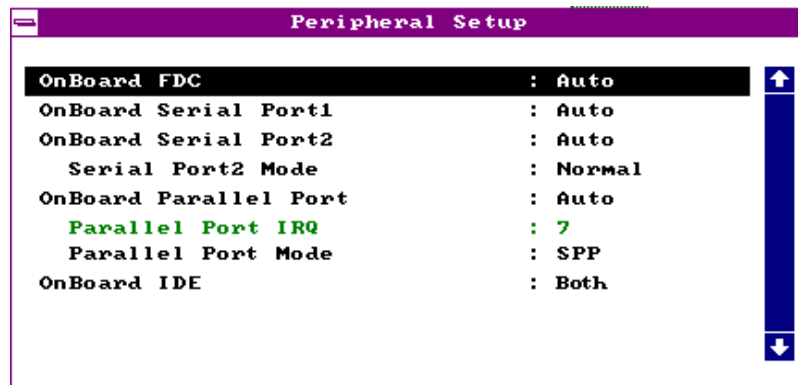

#### Onboard FDC

This parameter enables or disables the floppy drive controller.

#### Onboard Serial Port 1

This parameter allows you to select the address for the first serial port. The available settings are **Auto**, **3F8h**, **2F8h**, **3E8h**, **2E8h**, and **Disabled**. Selecting **Disabled** deactivates the port.

#### Onboard Serial Port 2

This parameter allows you to select the address for the second serial port. The available settings are **Auto**, **3F8h**, **2F8h**, **3E8h**, **2E8h**, and **Disabled**. Selecting **Disabled** deactivates the port.

#### SERIAL PORT 2 MODE

This parameter allows you to specify the serial port 2 mode. The available mode selections are:

- **Normal** – Sets serial port 2 to operate in normal mode. This is the default setting.

## AMI BIOS Utility

---

- **HPSIR** – Select this setting only if the InfraRed (IR) function is activated (i.e., an IR module is installed in your system). This setting allows infrared serial communication at a maximum baud rate of 115K baud.
- **ASKIR** – Select this setting only if the IR function is activated (i.e., an IR module is installed in your system). This setting allows infrared serial communication at a maximum baud rate of 19.2K baud.

### **Onboard Parallel Port**

This parameter allows you to select the address for the parallel port. The available settings are *Auto*, *378h*, *278h*, *3BCh*, and *Disabled*. Selecting *Disabled* deactivates the parallel port.

### **PARALLEL PORT IRQ**

This parameter allows you to set the interrupt for the parallel port. The default setting is 7.

### **PARALLEL PORT MODE**

This parameter specifies the parallel port mode. The mode options are *SPP*, *EPP*, and *ECP*. The default is *SPP*.

### **Onboard IDE**

This parameter enables or disables the IDE device(s) connected to your system. The selections are *Primary*, *Secondary*, *Both*, and *Disabled*.

## AMI BIOS Utility

### 3.3 Security Setup

The Security window contains the password and anti-virus features.

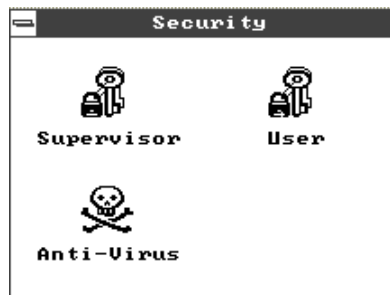

#### 3.3.1 Supervisor Password

The use of password prevents unauthorized use of your computer. If you set a Supervisor password, the system prompts for this password before granting access to Setup or system boot, depending on the Password Check setting in the Advanced CMOS Setup menu.

To set a Supervisor password, select **Supervisor** from the Security window. The following screen appears:

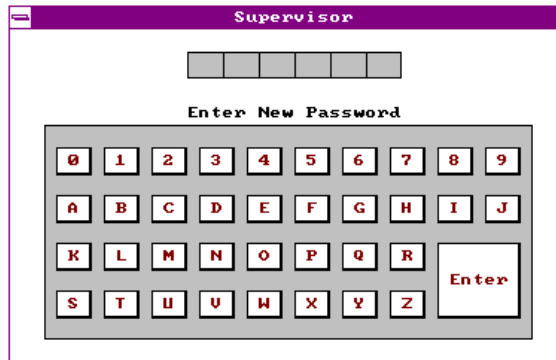

Follow these steps to set up a password using the keyboard:



## AMI BIOS Utility

1. Type in a six-character password using letters, numbers, or a combination of both. When you type the characters, they appear as asterisks on the password screen boxes.
2. Press <Enter>.
3. Retype the password when a password confirmation box appears asking you to retype the password.

You may also use the mouse and the characters on the screen to set up a password.

1. Click on six characters from the password screen. The characters appear on the boxes as asterisks.
2. Click on <Enter>.
3. Enter the password when a confirmation box appears.

### 3.3.2 User Password

To set a User password, select `User` from the Security window. The following screen appears:

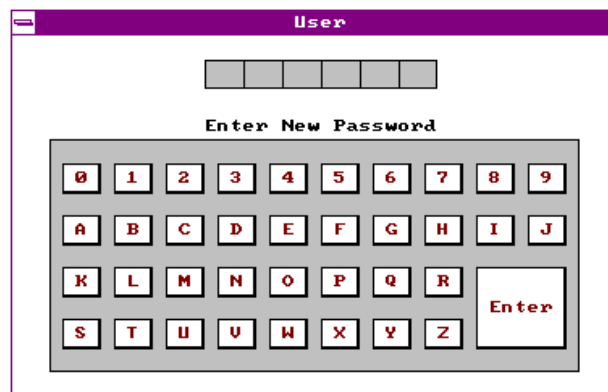

For instructions on how to enter a password, follow the procedures listed in section 3.3.1.



*If you set a Supervisor and a User password, you can enter either of the two entries when prompted for a password before system boot or entering*

## AMI BIOS Utility

---

*Setup.*

### 3.3.3 Anti-virus

Select *Anti-Virus* from the *Security* window to display the following option box.

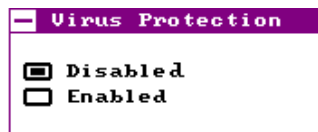

The virus protection options allow you to enable or disable the virus protection feature.

### 3.4 Utility Setup

The Utility window lets you change WinBIOS Setup colors and language setting.

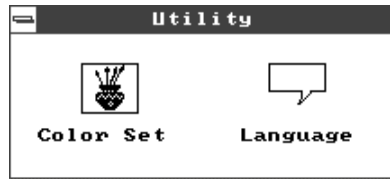

#### 3.4.1 Color Set

Select Color Set from the Utility window to display the following screen.



Use the arrow keys or simply click an option to select your desired background color for WinBIOS.

#### 3.4.2 Language

Select Language from the Utility window to display the following screen.

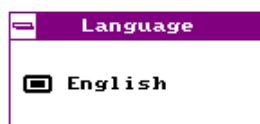

The system language currently supported is only English. Therefore, this option is non-configurable and is for display only.

## AMI BIOS Utility

---

### 3.5 Default Setup

The Default window allows you to select a group of settings for all WinBIOS Setup options.



#### 3.5.1 Original

When you select *Original*, a dialog box prompts you to restore the original BIOS default values. Select *No* to keep your current settings. Select *Yes* to restore the original values.

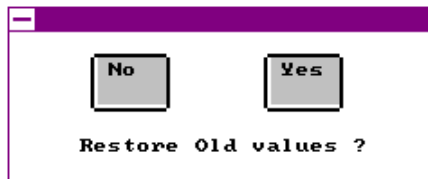

#### 3.5.2 Optimal

When you select *Optimal*, a dialog box prompts you to load the values that will help your system deliver optimum performance. Select *Yes* to load the BIOS optimum values. Select *No* to keep your current settings.

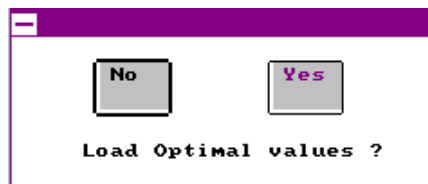

### 3.5.3 Turbo

When you select Turbo, a dialog box prompts you to load the Turbo values to further enhance system performance. Select Yes to load the Turbo values. Select No to keep your current settings.

In case your system operation becomes unstable and incompatibility problems occur, unload the Turbo values and

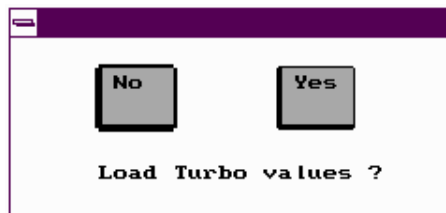

## AMI BIOS Utility

---

### 3.6 Exiting Setup

Carefully check your new settings when you have finished configuring the system. If correct, write them down and keep the recorded values in a safe place. If in the future, the battery loses power or the CMOS chip is damaged, you will know what values to enter when you rerun setup.

Press **ESC** to display the following screen.

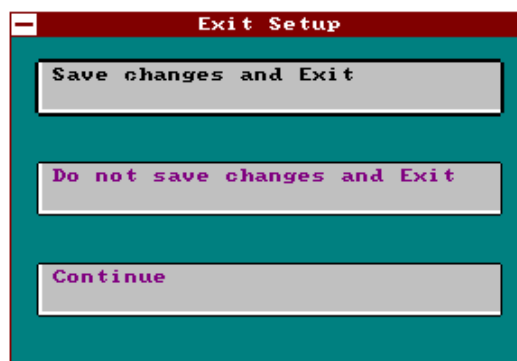

Press **↑** or **↓**, then **ENTER** or simply click on an option to select. Select **Save changes and Exit** to save the changes that you made. Select **Do not save changes and Exit** to leave setup without saving your changes. Select **Continue** if you want to make any more configuration changes.

### 3.7 NCR SCSI BIOS and Drivers

The NCR 53C810 SCSI BIOS resides on the same flash memory chip as the system BIOS. To use the onboard NCR BIOS, you need to install an NCR 53C810 SCSI controller card in your system.

All SCSI devices that you install in your system require software drivers. The NCR SCSI BIOS directly supports SCSI hard disks under DOS, Windows and OS/2. It also uses DOS-format and SCO UNIX-format support floppy disk device drivers that come with the NCR 53C810 SCSI controller card. The DOS-format device drivers are for SCSI devices used with DOS, Windows NT, Novell NetWare and OS/2. The SCO UNIX-format device drivers are for SCSI devices used with SCO UNIX. These drivers offer higher performance than the direct BIOS support.

To use the device drivers, you must install them in your system hard disk drive and add them to your system configuration files. For detailed installation instructions, see the README files that come with the drivers.

### 3.8 AMI Flash Utility

The AMI Flash Utility allows you to upgrade the system BIOS. To get the AMI flash utility and the upgrade BIOS file, contact your local distributor or visit our homepage at <http://www.aopen.com.tw>. The file name of AMI flash utility is AMIFLASH.EXE, run this program under DOS, follow the instruction on the screen, actually, you need only input the BIOS file name. After programming, reboot your system for the new BIOS to take effect.



**Warning:** Make sure you use AMI Flash Utility version 5.23 or later, the version before 5.23 has bug to program INTEL 12V Flash ROM, and after the programming, the system may fail to reboot.

**Warning:** Be sure you get the correct BIOS file and carefully read the instruction and notice from AOpen homepage. Use incorrect BIOS file on incorrect version of mainboard may damage your system.

# Appendix A

## Jumper Setting Summary

### CPU Voltage Select

<u>JP7</u>	<u>CPU Core Voltage (Vcore)</u>	<u>JP8</u>	<u>I/O Voltage (Vio)</u>
1-2	3.45V (Intel P54C or IDT C6)	1-2	3.45V (default)
3-4	3.52V (Cyrix or AMD K5)	3-4	3.52V
5-6	2.9V (AMD K6-166/200 or Cyrix M2)		
7-8	2.8V (MMX P55C)		
9-10	3.2V (AMD K6-233)		
11-12	2.1V (Reserved)		

<u>JP9</u>	<u>JP10</u>	<u>JP11</u>	<u>JP12</u>	<u>CPU Type (Vcpuio)</u>
1-2 & 3-4	Open	1-2 & 3-4	Open	Single Voltage CPU Vcpuio = Vcore (default)
Open	1-2 & 3-4	Open	1-2 & 3-4	Dual Voltage CPU Vcpuio = Vio (PP/MT P55C)



**Warning:** The heat dissipation of Intel PP/MT-233Hz, AMD K6-200/233MHz exceed the original design of this mainboard. Please make sure that you have installed CPU fan properly if Intel PP/MT-233 or AMD K6-200/233 is being selected to use. It may cause your system unstable if you can not meet the heat dissipation requirement from above CPU type. It is recommended to adopt larger fan on these CPU for better air flow in the system.

CPU	Vcore	Vio	Vcpuio	JP7	JP8	JP9	JP10	JP11	JP12
-----	-------	-----	--------	-----	-----	-----	------	------	------



## Jumper Table Summary

Type									
Intel P54C	3.45V	3.45V	Vcore	1-2	1-2	1-2, 3-4	Open	1-2, 3-4	Open
Intel MMX (P55C)	2.8V	3.45V	Vio	7-8	1-2	Open	1-2, 3-4	Open	1-2, 3-4
AMD K5 (Single voltage)	3.52V	3.45V	Vcore	3-4	1-2	1-2, 3-4	Open	1-2, 3-4	Open
AMD K6-166/200	2.9V	3.45V	Vio	5-6	1-2	Open	1-2, 3-4	Open	1-2, 3-4
AMD K6-233	3.2V	3.45V	Vio	9-10	1-2	Open	1-2, 3-4	Open	1-2, 3-4
Cyrix 6x86	3.52V	3.45V	Vcore	3-4	1-2	1-2, 3-4	Open	1-2, 3-4	Open
Cyrix 6x86L	2.8V	3.45V	Vio	7-8	1-2	Open	1-2, 3-4	Open	1-2, 3-4
Cyrix M2	2.9V	3.45V	Vio	5-6	1-2	Open	1-2, 3-4	Open	1-2, 3-4
IDT C6	3.45V	3.45V	Vcore	1-2	1-2	1-2, 3-4	Open	1-2, 3-4	Open

## CPU Frequency Select

<u>JP1</u>	<u>JP2</u>	<u>CPU Frequency Ratio</u>	<u>JP3</u>	<u>JP4</u>	<u>CPU External Clock</u>
1-2	1-2	1.5x (3.5x)	2-3	2-3	50MHz
2-3	1-2	2x	1-2	2-3	60MHz
2-3	2-3	2.5x (1.75x)	2-3	1-2	66MHz
1-2	2-3	3x			

Intel Pentium	CPU Core Frequency	Ratio	External Bus Clock	JP1 & JP2	JP3 & JP4
P54C 75	75MHz =	1.5x	50MHz	1-2 & 1-2	2-3 & 2-3
P54C 90	90MHz =	1.5x	60MHz	1-2 & 1-2	1-2 & 2-3
P54C 100	100MHz =	1.5x	66MHz	1-2 & 1-2	2-3 & 1-2
P54C 120	120MHz =	2x	60MHz	2-3 & 1-2	1-2 & 2-3
P54C 133	133MHz =	2x	66MHz	2-3 & 1-2	2-3 & 1-2
P54C 150	150MHz =	2.5x	60MHz	2-3 & 2-3	1-2 & 2-3
P54C 166	166MHz =	2.5x	66MHz	2-3 & 2-3	2-3 & 1-2
P54C 200	200MHz =	3x	66MHz	1-2 & 2-3	2-3 & 1-2
Intel Pentium	CPU Core Frequency	Ratio	External Bus Clock	JP1 & JP2	JP3 & JP4

## Jumper Table Summary

PP/MT 150	150MHz =	2.5x	60MHz	2-3 & 2-3	1-2 & 2-3
PP/MT 166	166MHz =	2.5x	66MHz	2-3 & 2-3	2-3 & 1-2
PP/MT 200	200MHz =	3x	66MHz	1-2 & 2-3	2-3 & 1-2
PP/MT 233	233MHz =	3.5x	66MHz	1-2 & 1-2	2-3 & 1-2

IDT C6	CPU Core Frequency	Ratio	External Bus Clock	JP1 & JP2	JP3 & JP4
WinChip 180	180MHz =	3x	66MHz	1-2 & 2-3	1-2 & 2-3
WinChip 200	200MHz =	3x	66MHz	1-2 & 2-3	2-3 & 1-2

Cyrix 6x86	CPU Core Frequency	Ratio	External Bus Clock	JP1 & JP2	JP3 & JP4
P120+	100MHz =	2x	50MHz	2-3 & 1-2	2-3 & 2-3
P150+	120MHz =	2x	60MHz	2-3 & 1-2	1-2 & 2-3
P166+	133MHz =	2x	66MHz	2-3 & 1-2	2-3 & 1-2

Cyrix M2	CPU Core Frequency	Ratio	External Bus Clock	JP1 & JP2	JP3 & JP4
MX-PR166	150MHz =	2.5x	60MHz	2-3 & 2-3	1-2 & 2-3
MX-PR200	166MHz =	2.5x	66MHz	2-3 & 2-3	2-3 & 1-2
MX-PR233	200MHz =	3x	66MHz	1-2 & 2-3	2-3 & 1-2
MX-PR266	233MHz =	3.5x	66MHz	1-2 & 1-2	2-3 & 1-2

AMD K5	CPU Core Frequency	Ratio	External Bus Clock	JP1 & JP2	JP3 & JP4
PR90	90MHz =	1.5x	60MHz	1-2 & 1-2	1-2 & 2-3
PR100	100MHz =	1.5x	66MHz	1-2 & 1-2	2-3 & 1-2
PR120	90MHz =	1.5x	60MHz	1-2 & 1-2	1-2 & 2-3
PR133	100MHz =	1.5x	66MHz	1-2 & 1-2	2-3 & 1-2
PR166	116MHz =	1.75x	66MHz	2-3 & 2-3	2-3 & 1-2

AMD K6	CPU Core Frequency	Ratio	External Bus Clock	JP1 & JP2	JP3 & JP4
PR2-166	166MHz =	2.5x	66MHz	2-3 & 2-3	2-3 & 1-2
PR2-200	200MHz =	3x	66MHz	1-2 & 2-3	2-3 & 1-2
PR2-233	233MHz =	3.5x	66MHz	1-2 & 1-2	2-3 & 1-2

## Jumper Table Summary

---

### Enable/Disable Onboard Super I/O Controller

<u>JP18</u>	<u>Onboard Super I/O</u>
1-2	Enabled (default)
2-3	Disabled

### Enable/Disable PS/2 Mouse Function

<u>JP20</u>	<u>PS/2 Mouse</u>
1-2	Enabled (default)
2-3	Disabled

### Clearing CMOS

<u>JP14</u>	<u>Clear CMOS</u>
1-2	Normal operation (default)
2-3	Clear CMOS

### DIMM Memory Type Select

<u>JP25</u>	<u>Memory Type</u>
Open	SDRAM
1-2 & 3-4	EDO

---

## Appendix B

### Frequently Asked Question



**Note:** FAQ may be updated without notice. If you cannot find the information that you need in this appendix, visit our WWW home page, (address: <http://www.aopen.com.tw>) and check the FAQ area and other new information.

**Q: How can I identify the mainboard BIOS version?**

A: The AOpen mainboard BIOS version appears on the upper-left corner of the POST (Power-On Self Test) screen. Normally, it starts with R and is found in between the model name and the date. For example:

AP53/AX53 R3.80 Oct.22.1996

↙  
BIOS revision

**Q: How can I identify version of the mainboard?**

A: The AOpen mainboard version appears as ppppp-x on the PCB, near the PCI slot and is enclosed in a white bordered box. The ppppp is the project code used by AOpen internally and -x is the version code. For example, for AP53 with 95140 project code and -3 version code, the mainboard version appears on the PCB as follows:

AP53 95140-3 MADE IN TAIWAN

↙  
MB verison -3  
(AP53-3)

## Frequently Asked Questions

---

**Q: Why the AOpen mainboards (MB) do not have cache module expansion slot?**

A: Faster CPU speed requires more difficult and complex MB timing design. Every trace and components delay must be taken into consideration. The expansion cache slot design will cause 2 or 3ns delay in PBSRAM timing, and the extended trace length to the cache module through the golden finger will further delay the timing by 1 or 2ns. This may result in unreliable system once the cache module and slot becomes worn. All AOpen MBs support 512KB PBSRAM onboard. For better performance (around 3% higher than 256KB), we strongly recommend you to use 512KB onboard. Otherwise, reliable 256KB is better than unreliable 512KB with cache module. AOpen is the first company to promote this concept since the fourth quarter of 1995.

**Q: Why do AOpen MBs have two regulators onboard?**

A: Heat dissipation becomes a big problem when CPU speed increases. New generation CPUs use lower voltage or split power plane to reduce power dissipation. If you use dual-power PP/MT (P55C) CPU, then you need separate regulators for 3.3V CPU io voltage and 2.8V CPU core voltage. Refer to section 2.2 "Jumper Settings" for voltage of current CPUs available on the market. Theoretically, the more regulators, the more reliable power becomes. For VX chipset MB (AP5V), we even incorporated a third regulator to support SDRAM. AOpen fully supports PP/MT and SDRAM in its product line and this puts them ahead among other companies. There is one exception, ATX MB may use 3.3V power from ATX power supply, it is possible to reduce one regulator.

**Q: What is the difference of Linear Regulator and Switching Regulator?**

A: Switching regulator turns on/off Power FET with very high frequency and uses L/C charge and discharge circuit to do voltage drop. The efficient is better but voltage ripple and EMI noise is higher. The reason for mainboard designer to consider switching regulator, is simply because they are worry about linear regulator can not fully support the coming new CPU. Actually, this depends on the design and layout quality of mainboard manufacturer. According to AOpen RD's testing, Intel PP/MT-233, AMD K6-166/200/233 are all fine on AP5T to run winstone97. (The CPU is at 53 degree C, heatsink is at 60 degree C and regulator IC is at 79 degree C). But for future CPU (perhaps CPU of 1998), AOpen will still consider to phase-in switching regulator on new version mainboard.

## Frequently Asked Questions

---

**Q: What is MMX?**

A: MMX is the new single-line multiple-instruction technology of the new Intel Pentium PP/MT (P55C) and Pentium II (Klamath) CPU. The AMD K6 and Cyrix M2 will support MMX too. The MMX instructions are specifically useful for multimedia applications (such as 3D video, 3D sound, video conference). The performance can be improved if applications use these instructions. All AOpen MBs have at least dual power onboard to support MMX. It is not necessary to have special chipset for MMX CPU.

**Q: What is USB (Universal Serial Bus)?**

A: USB is a new 4-pin serial peripheral bus that is capable of cascading low/medium speed peripherals (less than 10Mbit/s) such as keyboard, mouse, joystick, scanner, printer and modem/ISDN. With USB, the traditional complex cables from back panel of your PC can be eliminated.

You need the USB driver to support USB device(s). AOpen MBs are all USB ready, you may get latest BIOS from AOpen web site (<http://www.aopen.com.tw>). Our latest BIOS includes the keyboard driver (called Legacy mode), that simulates USB keyboard to act as AT or PS/2 keyboard and makes it possible to use USB keyboard if you don't have driver in your OS. For other USB devices, you may get the drivers from your device vendor or from OS (such as Win95). Be sure to turn off "USB Legacy Support" in BIOS "Chipset Setup" if you have another driver in your OS.

**Q: What is P1394?**

A: P1394 (IEEE 1394) is another standard of high-speed serial peripheral bus. Unlike low or medium speed USB, P1394 supports 50 to 1000Mbit/s and can be used for video camera, disk and LAN. Since P1394 is still under development, there is no P1394 device currently available in the PC market. Also, there is no chipset that can support P1394. Probably in the near future, a card will be developed to support P1394 device.

**Q: What is SMBus (System Management Bus, also called I2C bus)?**

A: SMBus is a two-wire bus developed for component communication (especially for semiconductor IC). It is most useful for notebook to detect component status and replace hardware configuration pin (pull-high or pull-low). For example, disabling clock of DIMM that does not exist, or detecting battery low condition. The data transfer rate of SMBus is only 100Kbit/s, it allows one host to communicate with CPU and many masters and slaves to send/receive message. The SMBus may be used for jumperless mainboard, the components which support SMBus are not ready yet, we will keep eyes on it.

**Q: When can we have real jumperless mainboard?**

A: PnP had achieved the goal of jumperless add-on card, but true jumperless mainboard still has some technical concerns. For example, CPU clock and

## Frequently Asked Questions

---

voltage do not have standard interface. Currently, the so called jumperless mainboard is actually depends on the BIOS to detect or manually set the CPU clock and voltage. If the setting is wrong, it will cause system unstable or damage after long time use. The other disadvantage is, because some of the jumper setting information is stored in CMOS, if the battery is lost or BIOS setup is accidentally changed, end user (or distributor) may need to open the housing and check the CPU again.

Most of all, you need a start voltage to boot CPU and go into BIOS for jumperless setting. 2.85V may be OK for P55C and K6-166, but minimum voltage of K6-233MHz is 3.1V, it can not boot if user plugs K6-233 onto current jumperless mainboard.

We probably need to wait after the mature of Smbus, if CPU and clock generator and other ICs are all Smbus compliance. Chipset can then detect and report the system configuration right after power on. Then we can have true jumperless mainboard.

### **Q: What is PBSRAM (Pipelined Burst SRAM)?**

A: For Pentium CPU, the Burst means reading four QWord (Quad-word, 4x16 = 64 bits) continuously with only the first address decoded by SRAM. The PBSRAM will automatically send the remaining three QWord to CPU according to predefined sequence. The normal address decoding time for SRAM is 2 to 3 clocks. This makes the CPU data read timing of four QWord to be at least 3-2-2-2 and a total of 9 clocks if traditional asynchronous SRAM is used. However, with PBSRAM, there is no need to decode address for rest three Qword. Therefore, data read timing can be 3-1-1-1, that is equivalent to 6 clocks and is faster than asynchronous SRAM.

### **Q: What is EDO (Extended Data Output) memory?**

A: The EDO DRAM technology of EDO is actually very similar to FPM (Fast Page Mode). Unlike traditional FPM that tri-states the memory output data to start the pre-charge activity, EDO DRAM holds the memory data valid until the next memory access cycle, that is similar to pipeline effect and reduces one clock state.

### **Q: What is SDRAM (Synchronous DRAM)?**

A: The SDRAM is a new generation DRAM technology that allows DRAM to use the same clock as the CPU host bus (EDO and FPM are asynchronous and do not have clock signal). The idea is the same as "Burst" (refer to the previous Q & A). It requires only one clock for the 2nd, 3rd, and 4th QWord (for example, 5-1-1-1 compares with EDO 5-2-2-2). The SDRAM comes in 64-bit 168-pin DIMM (Dual-in-line Memory Module) and operates at 3.3V. Note that some old DIMMs are made by FPM/EDO and only operate at 5V. Do not confuse them with SDRAM DIMM. AOpen is the first company to support dual-SDRAM DIMMs onboard (AP5V), from Q1 1996.

**B-4**

## Frequently Asked Questions

---

**Q: Can SDRAM DIMM work together with FPM/EDO SIMM?**

A: The FPM/EDO operate at 5V while SDRAM operates at 3.3V. The current MB design provides different power to DIMM and SIMM but connects the data bus together. If you combine SIMM and DIMM, the system will still work fine; however, only temporarily. After a few months, the SDRAM 3.3V data input will be damaged by 5V FPM/EDO data output line. Therefore, we strongly NOT recommend DIMM and SIMM combined together. There is one exception, if your SDRAM supports 5V tolerance (such as TI or Samsung), which accepts 5V signal at 3.3V operating power, you can combine them.

Manufacturer	Model	Suggested CAS Latency Time	5V Tolerance
Samsung	KM416511220AT-G12	2	Yes
NEC	D4S16162G5-A12-7JF	2	No
Hitachi	HM5216805TT10	2	No
TI	TMX626812DGE-12	2	Yes
TI	TMS626812DGE-15	3	Yes
TI	TMS626162DGE-15	3	Yes
TI	TMS626162DGE-M67	3	Yes

**Q: What is Bus Master IDE (DMA mode)?**

A: The traditional PIO (Programmable I/O) IDE requires the CPU to involve in all the activities of the IDE access including waiting for the mechanical events. To reduce the workload of the CPU, the bus master IDE device transfers data from/to memory without interrupting CPU, and releases CPU to operate concurrently while data is transferring between memory and IDE device. You need the bus master IDE driver and the bus master IDE HDD to support bus master IDE mode. Note that it is different with master/slave mode of the IDE device connection. For more details, refer to section 2.3 "Connectors".

**Q: What is the Ultra DMA/33?**

A: This is the new specification to improve IDE HDD data transfer rate. Unlike traditional PIO mode, which only uses the rising edge of IDE command signal to transfer data, the DMA/33 uses both rising edge and falling edge. Hence, the data transfer rate is double of the PIO mode 4 or DMA mode 2. (16.6MB/s x2 = 33MB/s).

The following table lists the transfer rate of IDE PIO and DMA modes. The IDE bus is 16-bit, which means every transfer is two bytes.

Mode	Clock per	Clock	Cycle	Data Transfer rate
------	-----------	-------	-------	--------------------



## Frequently Asked Questions

---

	<b>33MHz PCI</b>	<b>count</b>	<b>time</b>	
PIO mode 0	30ns	20	600ns	$(1/600\text{ns}) \times 2\text{byte} = 3.3\text{MB/s}$
PIO mode 1	30ns	13	383ns	$(1/383\text{ns}) \times 2\text{byte} = 5.2\text{MB/s}$
PIO mode 2	30ns	8	240ns	$(1/240\text{ns}) \times 2\text{byte} = 8.3\text{MB/s}$
PIO mode 3	30ns	6	180ns	$(1/180\text{ns}) \times 2\text{byte} = 11.1\text{MB/s}$
PIO mode 4	30ns	4	120ns	$(1/120\text{ns}) \times 2\text{byte} = 16.6\text{MB/s}$
DMA mode 0	30ns	16	480ns	$(1/480\text{ns}) \times 2\text{byte} = 4.16\text{MB/s}$
DMA mode 1	30ns	5	150ns	$(1/150\text{ns}) \times 2\text{byte} = 13.3\text{MB/s}$
DMA mode 2	30ns	4	120ns	$(1/120\text{ns}) \times 2\text{byte} = 16.6\text{MB/s}$
DMA/33	30ns	4	120ns	$(1/120\text{ns}) \times 2\text{byte} \times 2 = 33\text{MB/s}$

### **Q: What is PnP (Plug and Play)?**

A: In the past, the IRQ/DMA and memory or I/O space of add-on cards are normally set manually, i.e., by jumper or by proprietary utility. The user has to check the user's guide for the correct setting. Sometimes, resource conflict occurs and this leads to unstable system. The PnP specification suggests a standard register interface for both BIOS and OS (such as Win95). These registers are used by BIOS and OS to configure system resource and prevent any conflicts. The IRQ/DMA/Memory will be automatically allocated by PnP BIOS or OS.

Currently, almost all the PCI cards and most ISA cards are PnP compliant. If you are still using a Legacy ISA card that cannot support PnP, set the corresponding resource (IRQ/DMA/memory) to ISA in the BIOS "PCI/PnP Setup".

### **Q: What is ACPI (Advanced Configuration & Power Interface) and OnNow?**

A: The ACPI is new power management specification of 1997 (PC97). It intends to save more power by taking full control of power management to operating system and not through BIOS. Because of this, the chipset or super I/O chip needs to provide standard register interface to OS (such as Win97) and provides the ability for OS to shutdown and resume power of different part of chip. The idea is a bit similar to the PnP register interface.

ACPI defines momentary soft power switch to control the power state transition. Most likely, it uses the ATX form factor with momentary soft power switch. The most attractive part of ACPI for desktop user is probably the "OnNow" feature, an idea from notebook. This feature allows you to immediately resume to your original work without the long time waiting from bootup, entering Win95 and running Winword. The AX5T with Intel TX chipset can support ACPI.

## Frequently Asked Questions

---

**Q: What is the Modem Wake Up?**

A: With the help of ACPI OnNow and ATX soft power On/Off, it is possible to have system totally power off (The traditional suspend mode of power management function does not really turn off the system power supply), and wakeup to automatically answer a phone call such as answering machine or to send/receive fax. You may identify the true power off by checking fan of your power supply. Both external box modem and internal modem card can be used to support Modem Wake Up, but if you use external modem, you have to keep the box modem always power-on. AOpen AX5T/AX58 and internal modem card implement special circuit (patent applied) and make sure the modem card works properly without any power. We recommend you choose AOpen modem card (F56 or MP56) for Modem Wake Up applications.

**Q: What is the Suspend to Hard Drive?**

A: This is the same as Notebook. You can resume your original work directly from hard disk without go through the Win95 booting process and run your application again. Suspend to Hard Drive saves your current work (system status, memory image) into hard disk. If your memory is 16MB, normally, you need to reserve at least 16MB HDD space to save your memory image. ACPI OnNow is possible to do the same function, since the ACPI specification is not fully ready. AOpen AP5T/AX5T/AX58 support Suspend to Hard Drive through BIOS. Note that you have to use VESA compatible VGA (AOpen S3 Trio64V+ PV60), Sound Blaster compatible sound card (AOpen AW32 or MP32) for Suspend to Hard Drive to work properly. Of course, we recommend to use AOpen products for maximum compatibility.

**Q: Why will the system BIOS assign an IRQ to the PCI VGA card?**

A: Based on the PCI/PnP specification, system BIOS will automatically assign an IRQ to each PCI add-on card detected regardless of VGA requirement. If you do not want BIOS to assign an IRQ to the installed PCI VGA card, enter the BIOS PCI/PnP Setup and set the specific PCI slot IRQ Priority to "None".

**Q: Does Pentium or Pentium Pro MB support Deturbo mode?**

A: The Deturbo mode was originally designed to slow down CPU speed for old applications (especially old games). It uses programming loop to wait or delay special event. This programming method is considered very bad since the delay of loop highly depends on the CPU speed and the application fails at high-speed CPU. Almost all new applications (including games) use RTC or interrupt to wait event. There is no need for Deturbo mode now. The Turbo switch is now used as Suspend switch. However, some MBs still support Turbo/Deturbo function via keyboard. You can set the system to Deturbo by pressing <Ctrl> <Alt> <->. To back to Turbo mode, press <Ctrl> <Alt> <+>. Note that the Deturbo mode has been removed in new MBs since these require more code space in Flash ROM.

## Frequently Asked Questions

---

**Q: Power Management Icon does not appear in the Windows 95 Control Panel even though the APM under BIOS Setup is enabled.**

A: This problem occurs if you did not enable the APM function before you install Windows 95. If you have already installed Windows 95, re-install it after the BIOS APM function is enabled.

**Q: Why does the system fail to go into suspend mode under Win95?**

A: This problem may be caused by your CDROM settings. The CDROM Auto Insert Notification of Win95 is default enabled, the system will continue to monitor your CDROM, auto-execute application when a CD diskette is loaded, and prevents the system from entering into suspend mode. To resolve this, go into Control Panel → System → Device Manager → CDROM → Setting, and disable the "Auto Insert Notification" function.

**Q: What is Windows 95 Registry?**

A: The functions of Windows 95 Registry and the Windows 3.1 INI files are almost the same. Both store the hardware and software configurations. The only difference is that Registry is a database while INI is text file. You can run REGEDIT.EXE to further understand the Registry structure. Checking and studying the structure of this file will help you solve some configuration problems.

**Q: How to solve the error message "System Resource Conflict" on the BIOS POST screen?**

A: This error message appears when PnP BIOS detects a resource conflict while initializing the system resource during POST. You may try to force the PnP BIOS to reconfigure the resource by pressing <Ins> during POST.

**Q: Which version of the Windows '95 that I am using?**

A: You may determine the version of Windows '95 by following steps.

1. Double click "System" in "Control Panel".
2. Click "General".
3. Look for "System" heading & refer to following,

4.00.950	Windows 95
4.00.950A	Windows 95 + Service Pack or OEM Service Release 1
4.00.950B	OEM Service Release 2 or OEM Service Release 2.1

If you are running OSR 2.1, you may tell it from by checking "USB Supplement to OSR2" in the list of installed program of Add/Remove

## Frequently Asked Questions

---

program tool under Control Panel, and checking for version 4.03.1212 of the Ntkern.vxd file in the Windows\System\Wmm32 folder.

**Q: What is LDCM (LAN Desktop Client Manager)?**

A: This is a software of Intel. The major goal is to provide an easy way for corporate network administrator to monitor the status of all the clients (workstation). You need at least DMI BIOS for LDCM. AOpen BIOS is also DMI ready but unfortunately, Intel LDCM needs Intel network and ATI VGA card to work properly. It is obviously not suitable for home user to pay LDCM extra cost.